

Technical Documentation

Microphone Handbook

For the Falcon™ Range of Microphone Products

Brüel & Kjær 

WORLD HEADQUARTERS: DK-2850 Nærum • Denmark •
Telephone: +4542800500 • Telex: 37316 bruka dk • Fax: +4542801405 •
e-mail: info@bk.dk • Internet: <http://www.bk.dk>

Microphone Handbook

Revision February 1995

Trademarks

Microsoft is a registered trademark and **Windows** is a trademark of Microsoft Corporation.

Copyright © 1994, 1995, Brüel & Kjær A/S

All rights reserved. No part of this publication may be reproduced or distributed in any form or by any means without prior consent in writing from Brüel & Kjær A/S, Nærum, Denmark.

Contents

1. Introduction	1 – 1
1.1 About the Microphone Handbook.....	1 – 2
1.2 About the Falcon™ Range of Microphone Products.....	1 – 2
1.3 The Microphones.....	1 – 2
1.4 The Preamplifiers.....	1 – 8
2. Prepolarized Free-field 1/2" Microphone Type 4188	2 – 1
2.1 Introduction.....	2 – 2
2.2 Sensitivity.....	2 – 4
2.3 Frequency Response.....	2 – 5
2.4 Directional Characteristics.....	2 – 13
2.5 Dynamic Range.....	2 – 16
2.6 Equivalent Volume and Calibrator Load Volume.....	2 – 19
2.7 Capacitance.....	2 – 20
2.8 Polarization Voltage.....	2 – 20
2.9 Leakage Resistance.....	2 – 21
2.10 Stability.....	2 – 21
2.11 Effect of Temperature.....	2 – 22
2.12 Effect of Ambient Pressure.....	2 – 25
2.13 Effect of Humidity.....	2 – 26
2.14 Effect of Vibration.....	2 – 27
2.15 Effect of Magnetic Field.....	2 – 27
2.16 Electromagnetic Compatibility.....	2 – 27
2.17 Specifications Overview.....	2 – 28
2.18 Ordering Information.....	2 – 28
3. Prepolarized Free-field 1/2" Microphone Type 4189	3 – 1
3.1 Introduction.....	3 – 2
3.2 Sensitivity.....	3 – 5
3.3 Frequency Response.....	3 – 6
3.4 Directional Characteristics.....	3 – 14
3.5 Dynamic Range.....	3 – 15
3.6 Equivalent Volume and Calibrator Load Volume.....	3 – 18
3.7 Capacitance.....	3 – 20
3.8 Polarization Voltage.....	3 – 20
3.9 Leakage Resistance.....	3 – 21
3.10 Stability.....	3 – 21

3.11	Effect of Temperature	3 – 22
3.12	Effect of Ambient Pressure	3 – 25
3.13	Effect of Humidity	3 – 26
3.14	Effect of Vibration	3 – 27
3.15	Effect of Magnetic Field	3 – 27
3.16	Electromagnetic Compatibility	3 – 27
3.17	Specifications Overview	3 – 28
3.18	Ordering Information	3 – 28

4. Free-field $\frac{1}{2}$ " Microphone Type 4190

4 – 1

4.1	Introduction	4 – 2
4.2	Sensitivity	4 – 5
4.3	Frequency Response	4 – 6
4.4	Directional Characteristics	4 – 13
4.5	Dynamic Range	4 – 14
4.6	Equivalent Volume and Calibrator Load Volume	4 – 17
4.7	Capacitance	4 – 19
4.8	Polarization Voltage	4 – 19
4.9	Leakage Resistance	4 – 21
4.10	Stability	4 – 21
4.11	Effect of Temperature	4 – 22
4.12	Effect of Ambient Pressure	4 – 25
4.13	Effect of Humidity	4 – 27
4.14	Effect of Vibration	4 – 27
4.15	Effect of a Magnetic Field	4 – 27
4.16	Electromagnetic Compatibility	4 – 28
4.17	Specifications Overview	4 – 28
4.18	Ordering Information	4 – 28

5. Free-field $\frac{1}{2}$ " Microphone Type 4191

5 – 1

5.1	Introduction	5 – 2
5.2	Sensitivity	5 – 5
5.3	Frequency Response	5 – 6
5.4	Directional Characteristics	5 – 13
5.5	Dynamic Range	5 – 14
5.6	Equivalent Volume and Calibrator Load Volume	5 – 17
5.7	Capacitance	5 – 19
5.8	Polarization Voltage	5 – 19
5.9	Leakage Resistance	5 – 21
5.10	Stability	5 – 21
5.11	Effect of Temperature	5 – 22
5.12	Effect of Ambient Pressure	5 – 25
5.13	Effect of Humidity	5 – 27
5.14	Effect of Vibration	5 – 27
5.15	Effect of Magnetic Field	5 – 27

5.16	Electromagnetic Compatibility.....	5 – 28
5.17	Specifications Overview.....	5 – 28
5.18	Ordering Information.....	5 – 28

6. Pressure-field 1/2" Microphone Type 4192..... 6 – 1

6.1	Introduction.....	6 – 2
6.2	Sensitivity.....	6 – 5
6.3	Frequency Response.....	6 – 6
6.4	Directional Characteristics.....	6 – 13
6.5	Dynamic Range.....	6 – 14
6.6	Equivalent Volume and Calibrator Load Volume.....	6 – 17
6.7	Capacitance.....	6 – 19
6.8	Polarization Voltage.....	6 – 19
6.9	Leakage Resistance.....	6 – 21
6.10	Stability.....	6 – 21
6.11	Effect of Temperature.....	6 – 22
6.12	Effect of Ambient Pressure.....	6 – 25
6.13	Effect of Humidity.....	6 – 27
6.14	Effect of Vibration.....	6 – 27
6.15	Effect of Magnetic Field.....	6 – 27
6.16	Electromagnetic Compatibility.....	6 – 28
6.17	Specifications Overview.....	6 – 28
6.18	Ordering Information.....	6 – 28

7. Low-frequency Pressure-field 1/2" Microphone Type 4193..... 7 – 1

7.1	Introduction.....	7 – 2
7.2	Sensitivity.....	7 – 5
7.3	Frequency Response.....	7 – 7
7.4	Directional Characteristics.....	7 – 15
7.5	Dynamic Range.....	7 – 16
7.6	Equivalent Volume and Calibrator Load Volume.....	7 – 20
7.7	Capacitance.....	7 – 22
7.8	Polarization Voltage.....	7 – 22
7.9	Leakage Resistance.....	7 – 24
7.10	Stability.....	7 – 24
7.11	Effect of Temperature.....	7 – 26
7.12	Effect of Ambient Pressure.....	7 – 28
7.13	Effect of Humidity.....	7 – 30
7.14	Effect of Vibration.....	7 – 30
7.15	Effect of Magnetic Field.....	7 – 30
7.16	Electromagnetic Compatibility.....	7 – 31
7.17	Specifications Overview.....	7 – 31
7.18	Ordering Information.....	7 – 32

8.	$\frac{1}{2}$ " Microphone Preamplifier Type 2669.....	8-1
8.1	Introduction.....	8-2
8.2	Frequency Response.....	8-4
8.3	Dynamic Range	8-5
8.4	Phase Response	8-8
8.5	Effect of Temperature	8-8
8.6	Effect of Magnetic Fields	8-9
8.7	Electromagnetic Compatibility (EMC).....	8-9
8.8	Brüel & Kjær's Patented Charge-injection Calibration Technique.....	8-10
8.9	Specifications Overview	8-11
8.10	Ordering Information.....	8-11
9.	Accessories	9-1
9.1	Accessories Available	9-2

Index

Chapter 1

Introduction

1.1 About the Microphone Handbook

This handbook contains specific information about Brüel & Kjær's Falcon™ Range of 1/2" microphone products. It contains a chapter on each of the microphones, a chapter on 1/2" Microphone Preamplifier Type 2669 which can be used with these microphones, and a list of the available accessories which can also be used with these microphones.

1.2 About the Falcon™ Range of Microphone Products

Brüel & Kjær's Falcon™ Range of microphone products includes six 1/2" condenser microphones and a microphone preamplifier covering, between them, a very wide range of needs and applications.

They are the culmination of over 40 years of leadership in top quality condenser microphones and preamplifiers for precision acoustic measurements. The Falcon™ Range of microphone products will meet your demands whether they be in complying with ANSI or IEC standards or in acoustic research.

1.3 The Microphones

1.3.1 Robust and Stable

The microphones in the Falcon™ Range are robust and can even withstand an IEC 68-2-32 1m drop test onto a hard wooden block without suffering more than ±0.1dB change in sensitivity. They are made of carefully selected materials and alloys to ensure excellent stability and are virtually unaffected by industrial and similarly hostile environments. During manufacture, each microphone is artificially aged at a high temperature to ensure good long-term stability. As a result of all this, Brüel & Kjær has extended their warranty period to three years.

No ecologically damaging materials are used in the manufacture and packaging of these microphones.

1.3.2 Selecting a Microphone for Your Needs

To make sure you select the right microphone to match your needs, you will probably have to consider one or more of the following:

- Standards (IEC or ANSI)
- Frequency range
- Polarization
- Sound field.

The following, together with the flow chart shown in Fig. 1.1 and the comparative list of specifications shown in Table 1.2, will help you to make your decision.

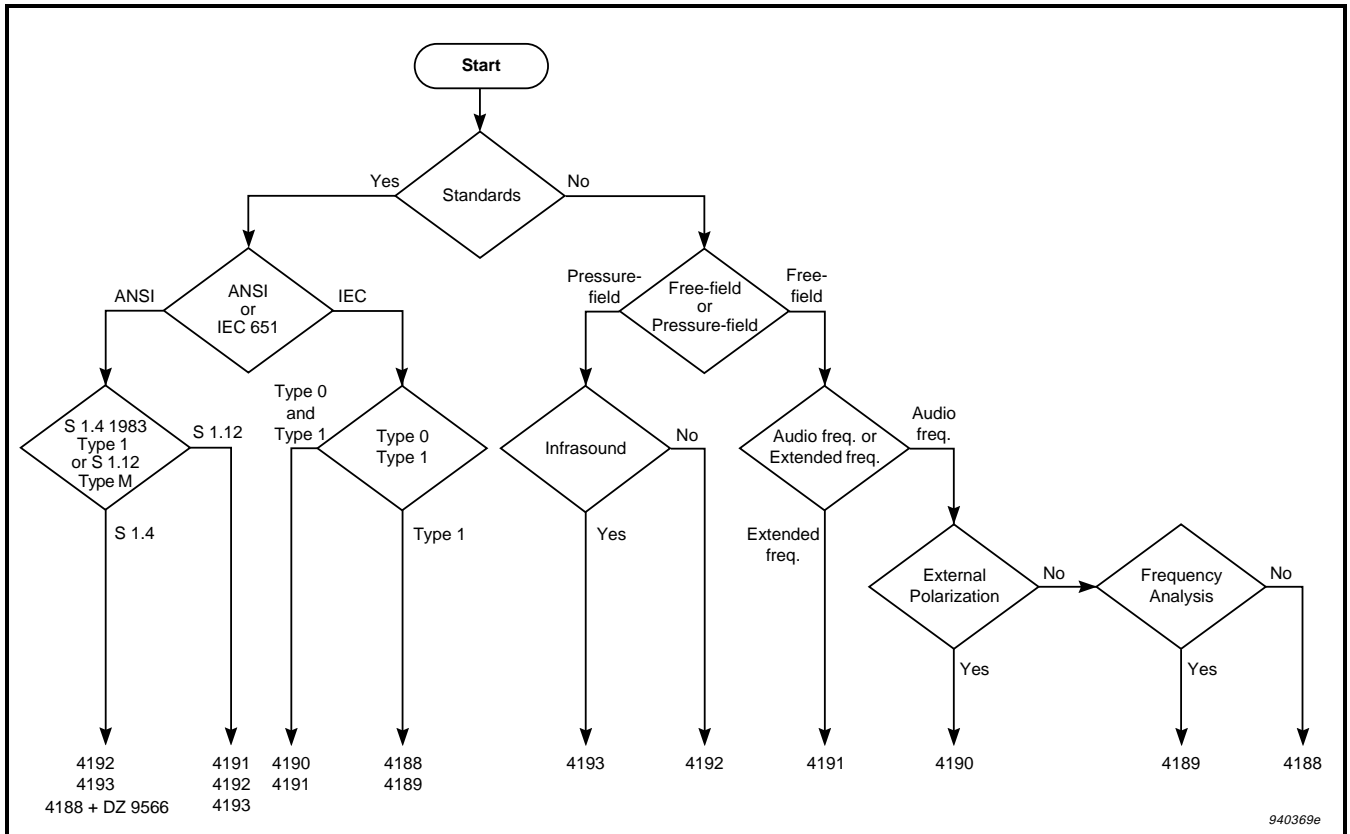

Fig. 1.1 Flow chart to help you choose the right microphone in the Falcon™ Range for your needs

Measurement Standards

You can use these microphones in noise measurement systems satisfying either ANSI or IEC standards (or their local equivalents). The microphones use only 50% to 70% of the tolerances allowed by these standards.

Frequency Ranges

All six microphones cover the audio frequency range. If, however, you want to measure at frequencies down to 0.07 Hz (for infrasound measurements), choose Low-frequency Pressure-field 1/2" Microphone Type 4193, or at frequencies up to 40 kHz (for harmonic distortion measurements on loudspeakers) choose Free-field 1/2" Microphone Type 4191.

Polarization/Preamplifier

Prepolarized microphones are required on certain portable sound level meters (which do not provide external polarization) and are a good choice in tough and

humid environments. Externally polarized microphones are more stable, also at high temperatures. All can be used with Brüel & Kjær's 1/2" Microphone Preamplifier Type 2669. The two prepolarized microphones (Types 4188 and 4189) can also be used with Brüel & Kjær's Preamplifier Type 2671.

Free-field Response or Pressure-field Response

The four free-field response microphones (Types 4188 to 4191) cover specific IEC requirements and should be used in sound fields where reflections are negligible. The two pressure-field response microphones (Types 4192 and 4193) should be used for measurements in acoustic couplers. They also cover specific ANSI requirements and can be used in diffuse sound fields.

As Replacements for Traditional Brüel & Kjær Microphones

Table 1.1 shows what traditional Brüel & Kjær microphones (type approval permitting) can be replaced by microphones from the Falcon™ Range.

Traditional Microphone	Falcon™ Range
4155	4189
4165	4190
4133/4149	4191
4134	4192
4147	4193
4166	4188* /4190* /4192*
4176	4188* /4189*

Table 1.1 Replacement of traditional Brüel & Kjær microphones with ones from the Falcon™ Range

Microphone Specifications

The design and construction of each microphone results in a reliable transducer of high sensitivity and low temperature dependence. Most of the data given for the microphones in this handbook are for open-circuit conditions, which means that the microphone looks into an infinitely high impedance. **Table 1.2** summarises the most important specifications for the microphones in the Falcon™ Range. In practice, however, a microphone is used with a preamplifier which slightly influences the given responses. When you use a Brüel & Kjær preamplifier (for example, 1/2" Microphone Preamplifier Type 2669), the input impedance is very high (high resistance, low capacitance), and the loading on the microphone cartridge is insignificant.

Specification	Type 4188	Type 4189	Type 4190	Type 4191	Type 4192	Type 4193
Description	Prepolarized Free-field	Prepolarized Free-field	Low Noise Free-field	Free-field	Pressure-field	Infrasound, Pressure-field
Nominal Open-circuit Sensitivity	31.6 mV/Pa	50 mV/Pa	50 mV/Pa	12.5 mV/Pa	12.5 mV/Pa	12.5 mV/Pa
Polarization Voltage	0	0	200	200	200	200
Optimized Frequency Response	±1 dB: 12.5 Hz to 8 kHz ±2 dB: 8 Hz to 12.5 kHz	±1 dB: 10 Hz to 8 kHz ±2 dB: 6.3 Hz to 20 kHz	±1 dB: 5 Hz to 10 kHz ±2 dB: 3.15 Hz to 20 kHz	±1 dB: 5 Hz to 16 kHz ±2 dB: 3.15 Hz to 40 kHz	±1 dB: 5 Hz to 12.5 kHz ±2 dB: 3.15 Hz to 20 kHz	±1 dB: 0.12 Hz to 12.5 kHz ±2 dB: 0.07 Hz to 20 kHz
Main Standards	IEC 651 Type 1, ANSI S1.4 1983	IEC 651 Type 1	IEC 651 Type 0 and Type 1	IEC 651 Type 0 and Type 1, ANSI S1.12 Type M	ANSI S1.4 Type 1, ANSI S1.12 Type M	ANSI S1.4 Type 1, ANSI S1.12 Type M
Lower Limiting Freq. (-3 dB)	1 to 5 Hz	2 to 4 Hz	1 to 2 Hz	1 to 2 Hz	1 to 2 Hz	10 to 50 mHz
Diaphragm Resonance Frequency	9 kHz	14 kHz	14 kHz	34 kHz	23 kHz	23 kHz
Inherent Noise	14.2 dB (A) 14.5 dB (Lin)	14.6 dB (A) 15.3 dB (Lin)	14.5 dB (A) 15.5 dB (Lin)	20.0 dB (A) 21.4 dB (Lin)	19.0 dB (A) 21.3 dB (Lin)	19.0 dB (A) 21.3 dB (Lin)
3% Distortion Limit	146 dB	146 dB	148 dB	162 dB	162 dB	162 dB
Maximum SPL (Peak)	157 dB	158 dB	159 dB	171 dB	171 dB	171 dB
Nominal Capacitance	12 pF	14 pF	16 pF	18 pF	18 pF	18 pF
Equivalent Volume	65 mm ³	46 mm ³	46 mm ³	11.6 mm ³	8.8 mm ³	8.8 mm ³
Calibrator Load Volume	208 mm ³	260 mm ³	250 mm ³	190 mm ³	190 mm ³	190 mm ³
Pistonphone 4228 Correction (with DP 0776)	+0.02 dB	0.00 dB	0.00 dB	+0.02 dB	+0.02 dB	+0.02 dB
Operating Temperature Range	-30 to 125 °C (-22 to 257 °F) (up to 70 °C with corrector)	-30 to 150 °C (-22 to 302 °F)	-30 to 150 °C (-22 to 302 °F) (can be used up to +300 °C (572 °F) but with a permanent sensitivity change of typically +0.4 dB which stabilises after one hour)			
Temperature Coefficient	+0.005 dB/°C	-0.001 dB/°C	-0.007 dB/°C	-0.002 dB/°C	-0.002 dB/°C	-0.002 dB/°C
Pressure Coefficient	-0.021 dB/kPa	-0.010 dB/kPa	-0.010 dB/kPa	-0.007 dB/kPa	-0.005 dB/kPa	-0.005 dB/kPa
Operating Humidity Range	0 to 100%RH (without condensation)					
Effect of Humidity	<0.1 dB/100%RH					
Effect of Vibration (SPL with axial 1 m/s²)	63.5 dB	62.5 dB	62.5 dB	65.5 dB	65.5 dB	65.5 dB
Effect of Magnetic Field (SPL with 80 A/m, 50 Hz field)	7 dB	6 dB	4 dB	16 dB	16 dB	16 dB

Table 1.2 Comparison of main specifications for the different microphones in the Falcon™ Range

1.3.3 Physical Dimensions

Dimensions (mm)	Type 4188	Type 4189	Type 4190	Type 4191	Type 4192	Type 4193
Microphone Length (with grid)	14.9	17.6	17.6	13.5	13.5	13.5
Housing Length (without grid)	14.0	16.3	16.3	12.6	12.6	12.6
Housing Diameter (± 0.03 mm)	12.7	12.7	12.7	12.7	12.7	12.7
Housing Front-end Length	6.4	6.2	6.2	6.1	6.1	6.1
Diaphragm Ring Diameter	12.0	12.0	12.0	12.0	12.0	12.0
Depth to Centre Terminal	4.6	4.6	4.6	4.6	4.6	4.6
Preamplifier Thread (60 UNS-2)	11.7	11.7	11.7	11.7	11.7	11.7
Preamplifier Thread Length	3.0	3.5	3.5	3.5	3.5	3.5
Protection Grid Thread (60 UNS-2)	12.7	12.7	12.7	12.7	12.7	12.7
Protection Grid Diameter (± 0.02 mm)	13.2	13.2	13.2	13.2	13.2	13.2

Table 1.3 Dimensions of the different microphones in the Falcon™ Range

1.3.4 Calibration

For general routine calibration you can check the sensitivity at 1 kHz with Sound Level Calibrator Type 4231, or at 250 Hz with Pistonphone Type 4228. For a thorough calibration, Multifunction Acoustic Calibrator Type 4226 allows you to measure both sensitivity and frequency response.

An in-situ check, which also takes the state of the microphone into account, is Brüel & Kjær's Charge-Injection Calibration technique which is a patented feature of $\frac{1}{2}$ " Microphone Preamplifier Type 2669 (see [Chapter 8](#)).

1.3.5 Microphone-data Disk

Introduction

A 3¹/₂" data disk which supplements the calibration chart is supplied with all microphones in the Falcon™ Range except Prepolarized Free-field 1/2" Microphone Type 4188.

It contains calibration data in the \DATA directory and a presentation program, Brüel & Kjær Microphone Viewer, in the root directory. The calibration data on each disk is described in the relevant chapters of the handbook. The Brüel & Kjær Microphone Viewer program must be installed on your computer's hard disk before use using the installation program SETUP.EXE supplied on the data disk (see below).

Computer Requirements

Brüel & Kjær Microphone Viewer requires:

- Windows™ version 3.1 installed on your computer
- 3¹/₂" 1.4 Mbyte disk drive
- 1.5 Mbytes free disk space
- VGA or SVGA display (minimum 640×480 pixels)

Installing Brüel & Kjær Microphone Viewer

1. Insert the data disk in drive A.
2. Start Windows.
3. Click on the File menu in the Program Manager.
4. Select Run and type A:\SETUP.EXE.
5. Click on OK.
6. When SETUP.EXE asks you where you want to install the program, click on OK.

Unless you have selected another directory, SETUP.EXE installs the program in C:\BK-MIC. Two files (VBRUN300.DLL and VER.DLL) are installed in the \WINDOWS\SYSTEM directory. These files are common for Visual Basic programs and can also be used by other programs.

About Brüel & Kjær Microphone Viewer

Brüel & Kjær Microphone Viewer shows the individual microphone's data supplied on the data disk in either graphical or tabular form.

When the program is started from Windows™, the calibration data in the \DATA directory of the disk in the A drive is shown. If no data is found, the Open box automatically appears. Select the Sensitivity file to access all data associated with the microphone. Selecting a Result or Work file will only give you access to that particular response.

The data can be copied to the hard disk using the Copy Microphone Data function in the File menu. Individual data files are named with the microphone's serial number to prevent file name conflicts with data files from other microphones.

The data shown can also be printed out or copied to the clipboard for further processing in spreadsheets and text editors.

When a Sensitivity file is selected, all frequency responses are obtained by adding the relevant corrections and the low-frequency response to the actuator response.

Any additional information about Brüel & Kjær Microphone Viewer can be seen in the README.TXT file. In addition, help in the form of hypertext is included throughout to guide you.

1.4 The Preamplifiers

The 1/2" Microphone Preamplifier Type 2669 has been developed for making precision acoustic measurements with Brüel & Kjær's wide range of condenser microphones. You can connect 1/2" microphones directly and 1", 1/4" and 1/8" types using adaptors.

The preamplifier, cable and its connectors all fulfil EMC requirements.

You can verify the condition of the microphone, preamplifier and cable in-situ using Brüel & Kjær's patented Charge-injection Calibration technique. This means that you can detect defects in the entire measurement set-up, including the microphone.

The preamplifier's low output impedance allows long extension cables to be used without problems.

The robust, compact design means that you can use the 1/2" Microphone Preamplifier Type 2669 over a wide range of environmental conditions. The cable, which you can detach from the preamplifier, is very thin but strong and remains flexible down to -20°C.

The 1/2" Microphone CCLD Preamplifier Type 2671 has been developed for use with prepolarised microphones in mind.

Full details of the 1/2" Microphone CCLD Preamplifier Type 2671 are available in the 2671 Product Data Sheet.

Chapter 2

Prepolarized Free-field 1/2" Microphone Type 4188

2.1 Introduction

2.1.1 Description

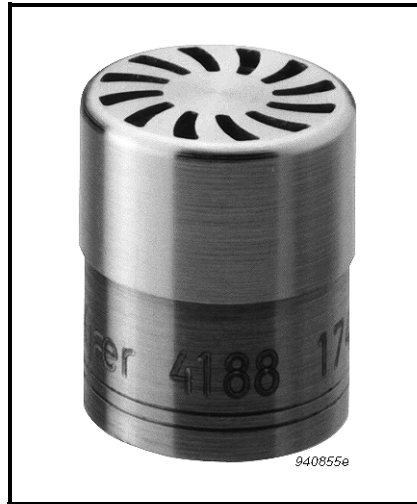

Fig. 2.1 Prepolarized Free-field $\frac{1}{2}$ " Microphone Type 4188 with Protection Grid DD 0525 (included)

Prepolarized Free-field $\frac{1}{2}$ " Microphone Type 4188 is a prepolarized $\frac{1}{2}$ " free-field microphone and offers some significant advantages when used with portable instruments. For example, smaller associated instruments with low power consumption can be used. A general advantage is the improved reliability of the associated preamplifier in humid and polluted atmospheres. These factors make this prepolarized condenser microphone particularly suitable for field measurements, both outdoors and in industrial environments. It is suited to IEC 651 Type 1 measurements and, when fitted with the supplied Random Incidence Corrector DZ 9566, is also suited to ANSI S 1.4–1983 Type 1 measurements.

The microphone is polarized by a fixed charge-carrying layer deposited on the backplate. This layer is negatively charged which, at low frequencies, results in a positively increasing output voltage for a positively increasing incident sound pressure. As a prepolarized microphone, it is externally marked by a pair of grooves.

This rugged microphone is built to ensure high stability under a variety of conditions. For example, the stainless steel alloy diaphragm withstands polluted industrial environments. The diaphragm clamping ring is firmly secured to ensure the microphone's reliability, even when the microphone is used without its protection grid. When the microphone is used without its protection grid, it can be easily flush-mounted or inserted into closed volumes as it can be supported by the diaphragm clamping ring, provided that a force of less than 5 Newtons is applied.

It is supplied with a calibration chart.

2.1.2 The Calibration Chart

Each microphone is supplied with an individual calibration chart (see Fig. 2.2) which gives the microphone's open-circuit pressure sensitivity together with the typical capacitance and free-field and random-incidence frequency responses*. When these are combined with the microphone's typical data supplied in this chapter, the individual microphone's response under various conditions can be determined.

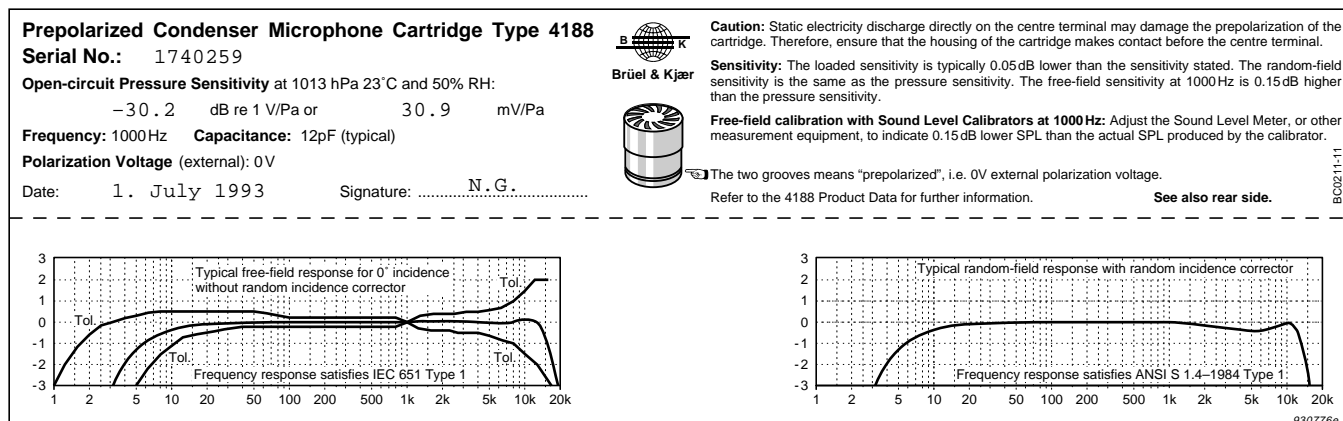

Fig. 2.2 Microphone calibration chart (front and back)

Open-circuit Sensitivity

The stated open-circuit pressure sensitivity is valid at the reference frequency (1000 Hz) for random-incidence and pressure-field conditions. The free-field sensitivity at the reference frequency (1000 Hz) is 0.11 dB higher than the pressure sensitivity.

Ambient Conditions

The ambient conditions are measured continuously during calibration at the factory. The calibration results obtained at the measured environmental calibration conditions are corrected to the stated reference ambient conditions (23°C, 101.325 kPa and 50% RH).

Frequency Responses

Two typical frequency responses are shown on the calibration chart. Both are normalized to 0dB at the reference frequency (1000 Hz).

The left-hand curve on the rear side of the calibration chart is the open-circuit 0°-incidence free-field response for the microphone without the supplied Random Incidence Corrector DZ 9566.

*Random-incidence response with supplied Random Incidence Corrector DZ 9566.

The right-hand curve on the rear side of the calibration chart is the open-circuit random-incidence response for the microphone with the supplied Random Incidence Corrector DZ 9566.

Each microphone's individual lower limiting frequency is measured to ensure that it is within the specified tolerances (see [Fig. 2.3](#)).

2.1.3 Recommended Recalibration Interval

With normal handling of the microphone and any associated instrument, Brüel & Kjær recommends that the microphone be recalibrated every 2 years.

Prepolarized Free-field 1/2" Microphone Type 4188 is very stable over this period (see [section 2.10](#) to [section 2.12](#)). Improper handling is by far the most likely cause of change in the microphone's properties. Any damage which causes improper operation can probably be detected using a sound level calibrator. In many cases, the damage can be seen by carefully inspecting the protection grid and diaphragm.

2.2 Sensitivity

2.2.1 Open-circuit Sensitivity

The open-circuit sensitivity is defined as the sensitivity of the microphone when not loaded by the input impedance of the connected preamplifier (the termination is described in IEC 1094-2). The sensitivity is measured for the individual microphone at 1000 Hz and stated on the microphone's calibration chart (see [section 2.1.2](#)). The nominal sensitivity is shown in [Table 2.1](#).

Nominal open-circuit sensitivity		Accepted Deviation (dB)
mV/Pa	dB re 1 V/Pa	
31.6	-30	±2

Table 2.1 Nominal open-circuit sensitivity

2.2.2 Loaded Sensitivity

When loaded by a preamplifier, the sensitivity of the microphone is given by:

$$S_C = S_O + G \quad (2.1)$$

where

- S_C = overall sensitivity of microphone and preamplifier combination
- S_O = open-circuit sensitivity of microphone
- G = voltage gain of microphone and preamplifier combination (in dB)

With Microphone Preamplifier Type 2639: $G = -0.15$ dB

With 1/2" Microphone Preamplifier Type 2669: $G = -0.30$ dB

Example

Loaded sensitivity of typical microphone with 1/2" Microphone Preamplifier Type 2669:

$$S_C = -29.8 + (-0.30) = -30.1 \text{ dB}$$

2.2.3 K-factor

Some types of Brüel & Kjær instruments use the K-factor (correction factor) or the K_O -factor (open-circuit correction factor) for calibration.

$$K = -26 - S_C \quad (2.2)$$

$$K_O = -26 - S_O \quad (2.3)$$

Example

Correction factor for typical microphone with 1/2" Microphone Preamplifier Type 2669:

$$K = -26 - (-30.1) = +4.1 \text{ dB}$$

Open-circuit correction factor for typical microphone with 1/2" Microphone Preamplifier Type 2669:

$$K_O = -26 - (-29.8) = +3.8 \text{ dB}$$

2.3 Frequency Response

2.3.1 General

In acoustic measurements, there are three types of sound field:

- Free field
- Pressure field
- Diffuse field

The microphone is optimized to have a flat frequency response in one of these sound fields. This response is called the optimized response. A microphone's response in a diffuse field is equivalent to its random-incidence response.

This section shows the microphone's typical free-field and random-incidence responses together with the microphone's typical actuator response obtained using Electrostatic Actuator UA 0033. The low-frequency response described in [section 2.3.4](#) is common for all types of response.

All frequency responses and correction curves are shown with a frequency resolution of 1/12-octave.

2.3.2 Optimized Response (0°-incidence Free-field Response)

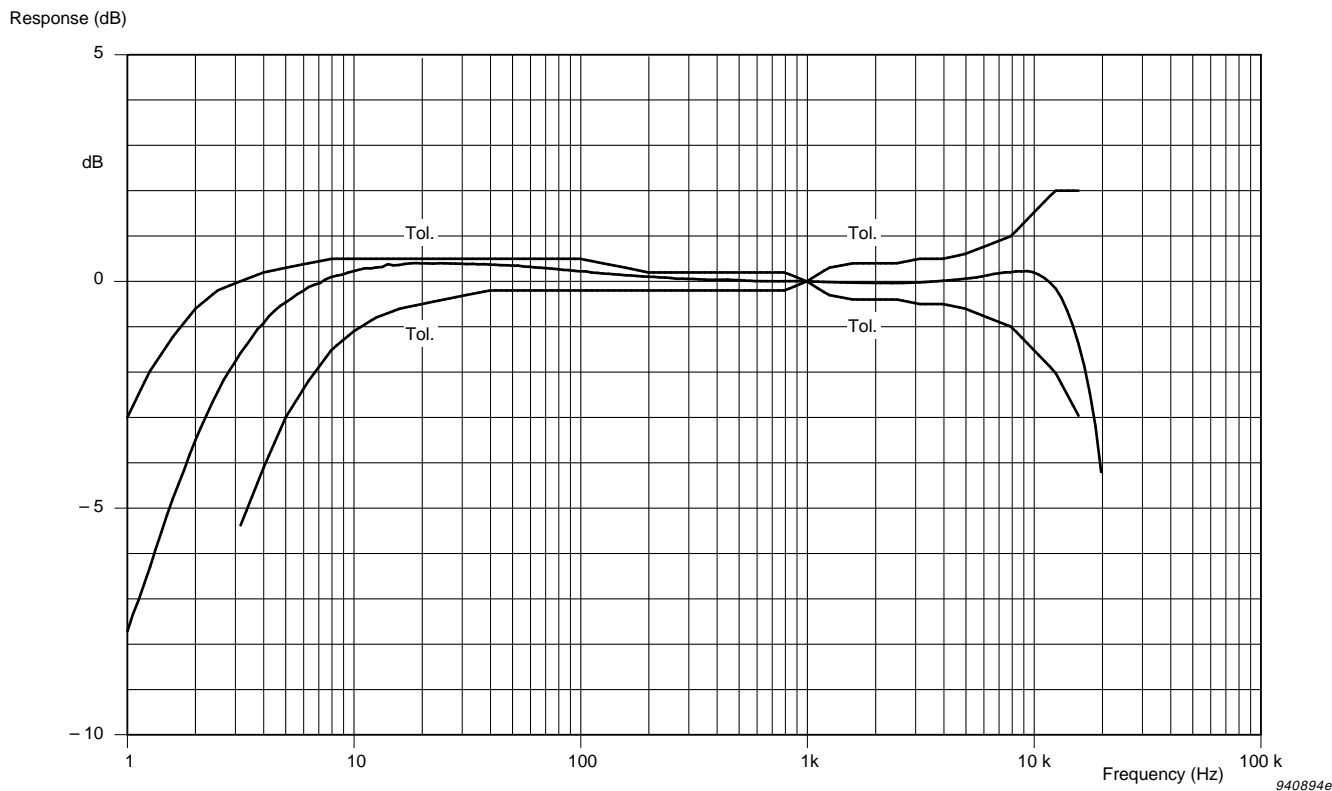

Fig. 2.3 Typical free-field response of the microphone with Protection Grid DD0525 and the microphone's specified tolerances. The low-frequency response is valid when the vent is exposed to the sound field

Prepolarized Free-field 1/2" Microphone Type 4188 meets the requirements of IEC 651, Type 1 and ANSI S1.4 – 1983 Type 1.

2.3.3 Actuator Response

The microphone's frequency response is determined by adding corrections for the type of sound field to its actuator response obtained using Electrostatic Actuator

UA 0033. This is a reproducible and practical method for calibrating a microphone's frequency response.

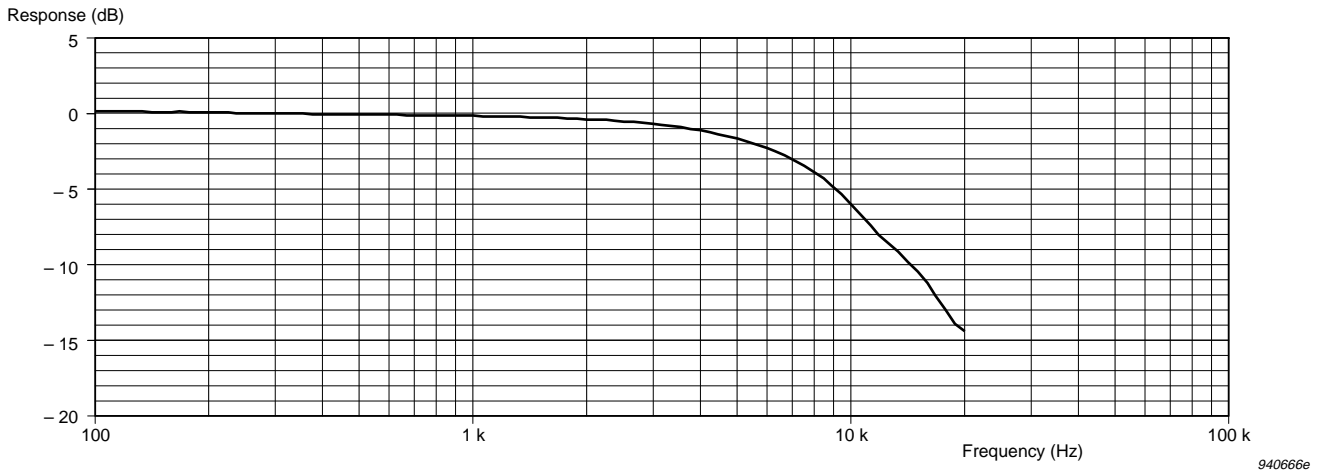

Fig.2.4 Typical actuator response measured with Electrostatic Actuator UA 0033

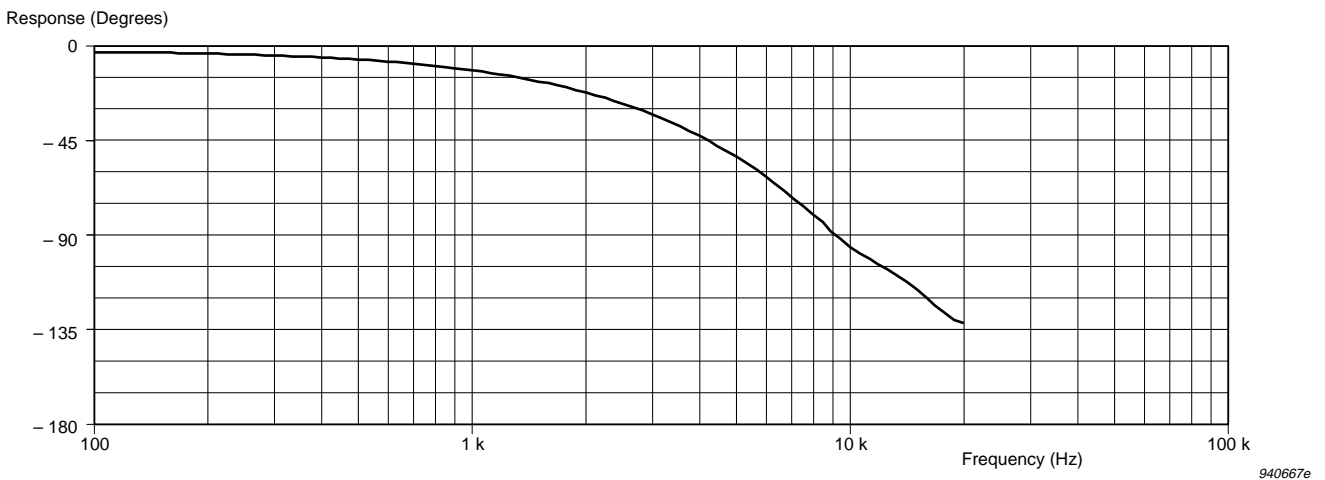

Fig.2.5 Typical actuator phase response measured with Electrostatic Actuator UA 0033

The microphone is polarized by a fixed charge-carrying layer deposited on the back-plate. This layer is negatively charged which, at low frequencies, results in a positively increasing output voltage for a positively increasing incident sound pressure.

2.3.4 Low-frequency Response

The low-frequency response (see Fig.2.3) is the typical response with the vent exposed to the sound field. If the vent is not exposed to the sound field, the sensitivity

increases from 0 dB at the reference frequency (1000 Hz) to approximately 0.6 dB at 1 Hz.

For applications where the vent is not exposed to the sound field, take care to ensure proper static pressure equalization to prevent static displacement of the diaphragm.

The microphone's low-frequency response is common for all types of sound field.

The microphone's lower limiting frequency (-3 dB) is between 1 and 5 Hz with the vent exposed to the sound field. This is measured during production to ensure that specifications are fulfilled.

2.3.5 Free-field Response

The microphone's free-field correction curves are shown in [Fig. 2.6](#), [Fig. 2.8](#) and [Fig. 2.10](#). These corrections are added to the microphone's actuator response obtained using Electrostatic Actuator UA 0033 in order to determine the free-field response at any angle of incidence. The typical free-field response at 0° incidence with and without the protection grid, and with Random Incidence Corrector DZ 9566 are shown in [Fig. 2.7](#), [Fig. 2.9](#) and [Fig. 2.11](#), respectively.

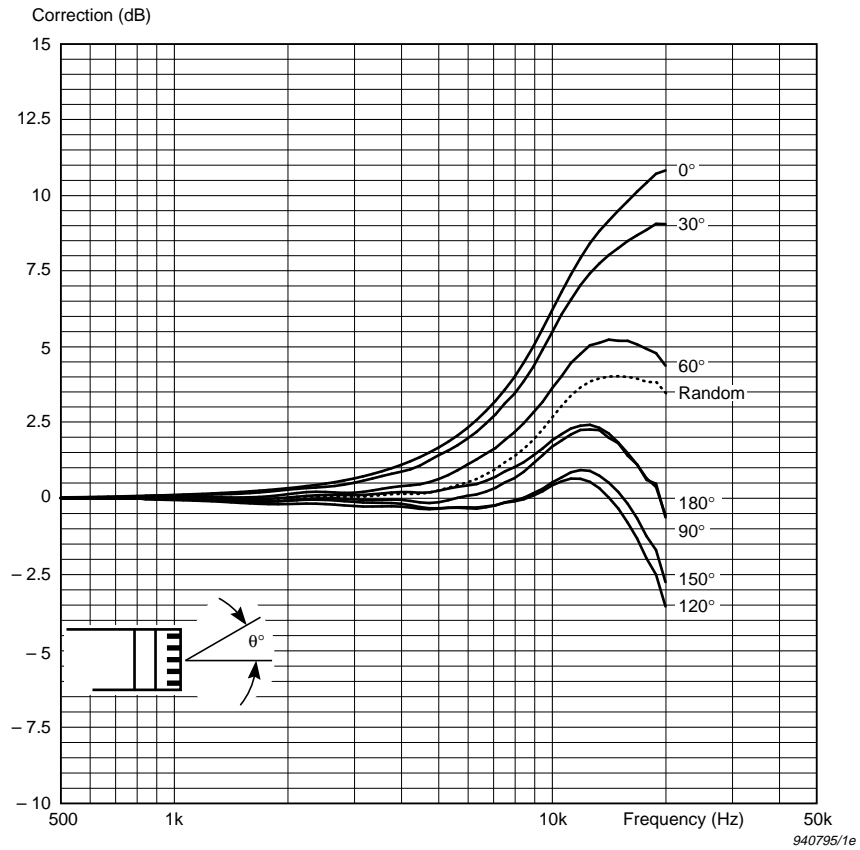

Fig. 2.6 Free-field correction curves for the microphone with Protection Grid DD 0525

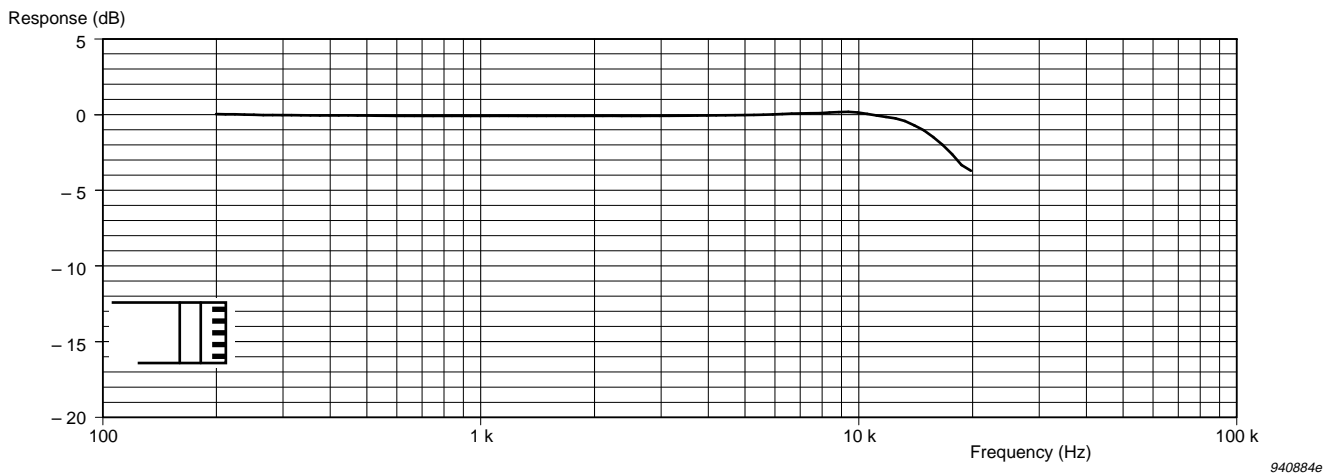

Fig. 2.7 Typical free-field response (0° incidence) for the microphone with Protection Grid DD 0525

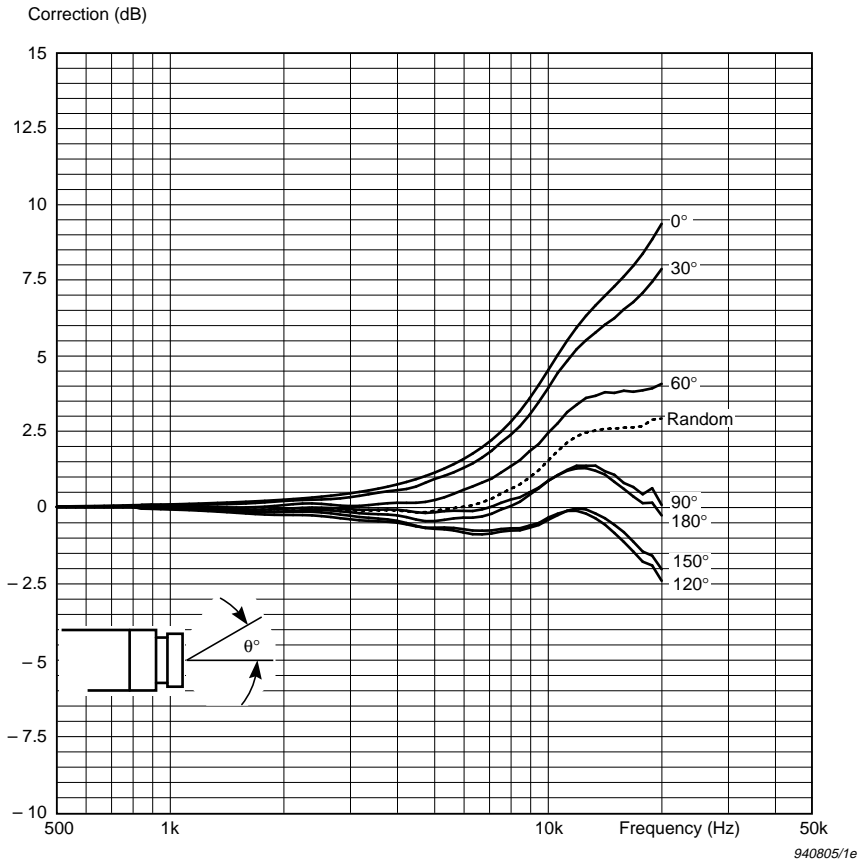

Fig.2.8 Free-field correction curves for the microphone without protection grid

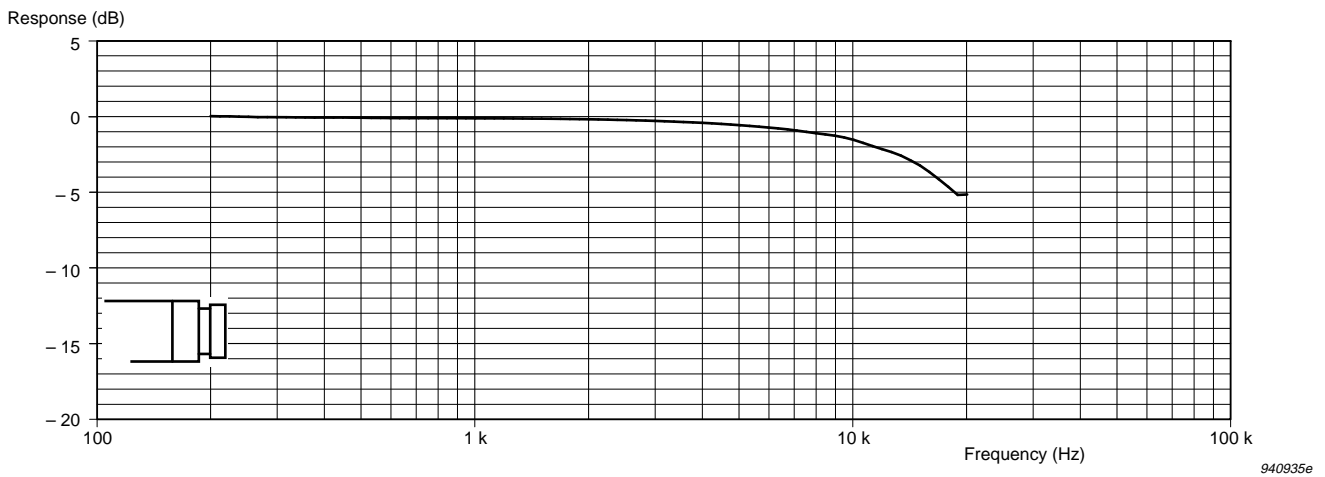

Fig.2.9 Typical free-field response (0°-incidence) for the microphone without protection grid

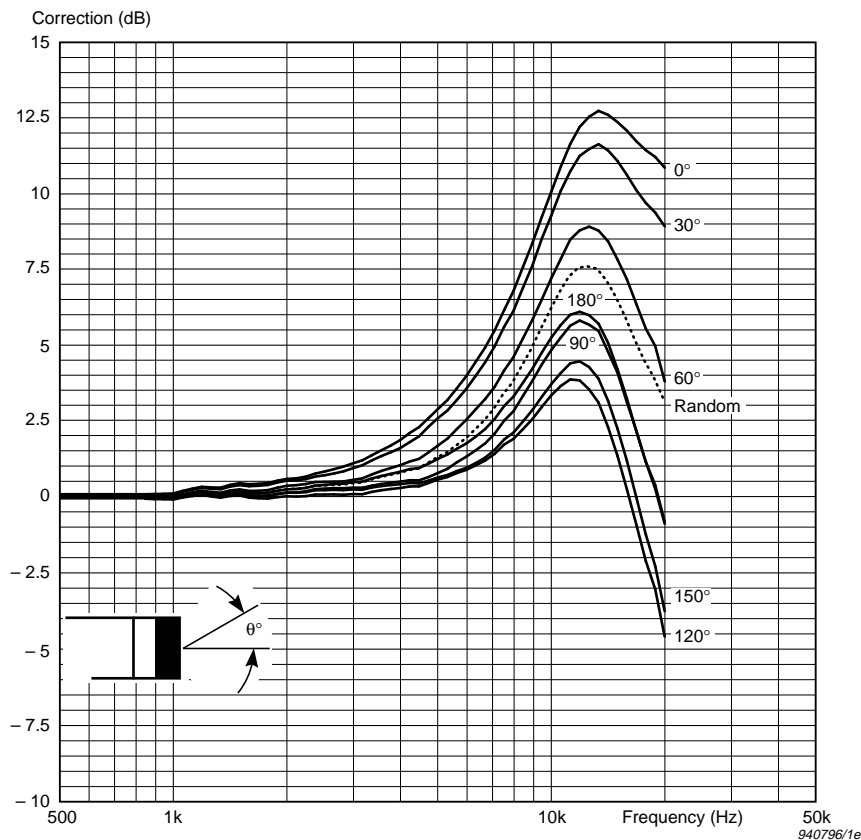

Fig.2.10 Free-field correction curves for the microphone with Random Incidence Corrector DZ 9566

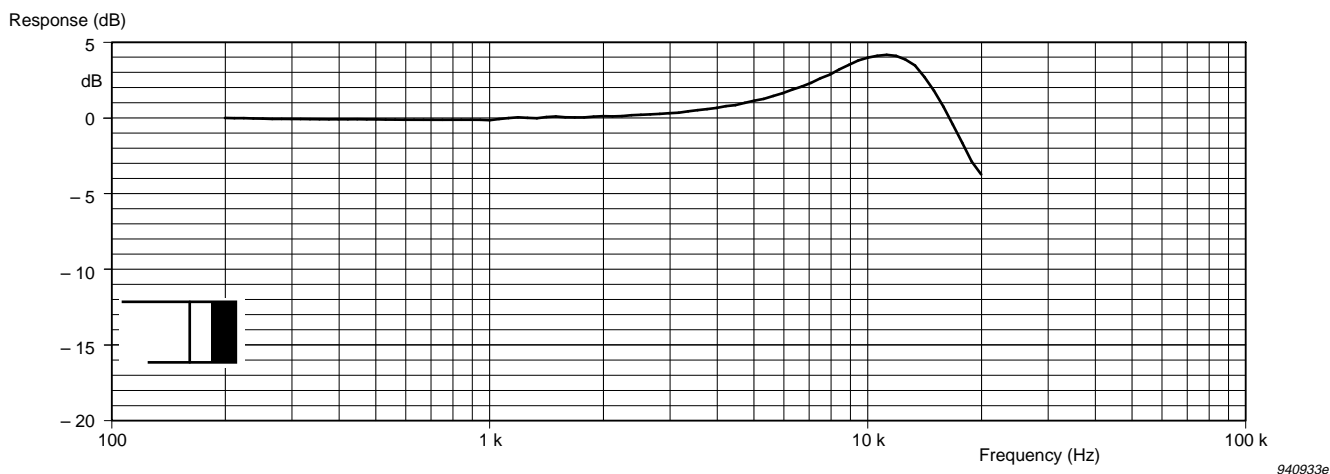

Fig.2.11 Typical free-field response (0°-incidence) for the microphone with Random Incidence Corrector DZ 9566

2.3.6 Random-incidence Response

A microphone's response in a diffuse sound field is equivalent to its random-incidence response. The microphone's random-incidence correction curves are shown in Fig. 2.6, Fig. 2.8 and Fig. 2.10. These corrections are added to the microphone's actuator response obtained using Electrostatic Actuator UA 0033 in order to determine the random-incidence response. The typical random-incidence with and without the protection grid, and with Random Incidence Corrector DZ 9566 are shown in Fig. 2.12, Fig. 2.13 and Fig. 2.14, respectively.

The random-incidence corrections are calculated from the free-field corrections measured in 5° steps according to Draft IEC 1183–1993.

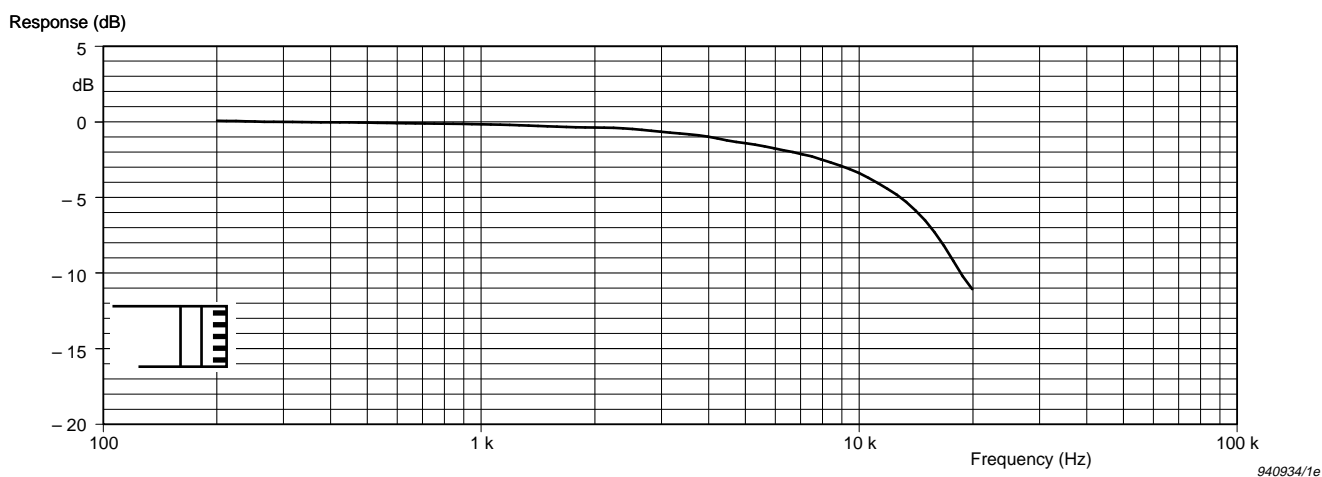

Fig. 2.12 Typical random-incidence response for the microphone with Protection Grid DD 0525

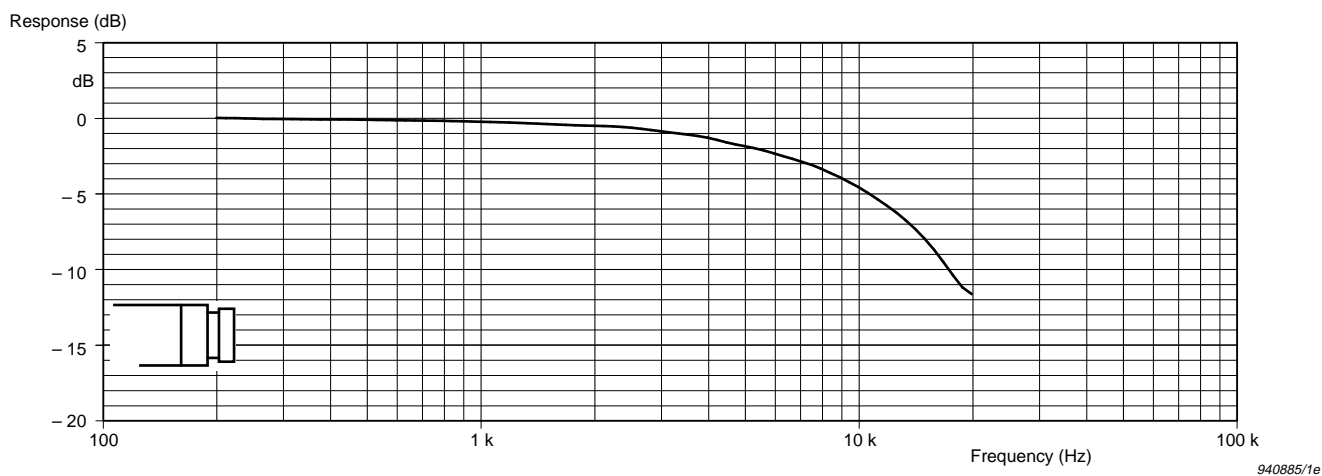

Fig. 2.13 Typical random-incidence response for the microphone without protection grid

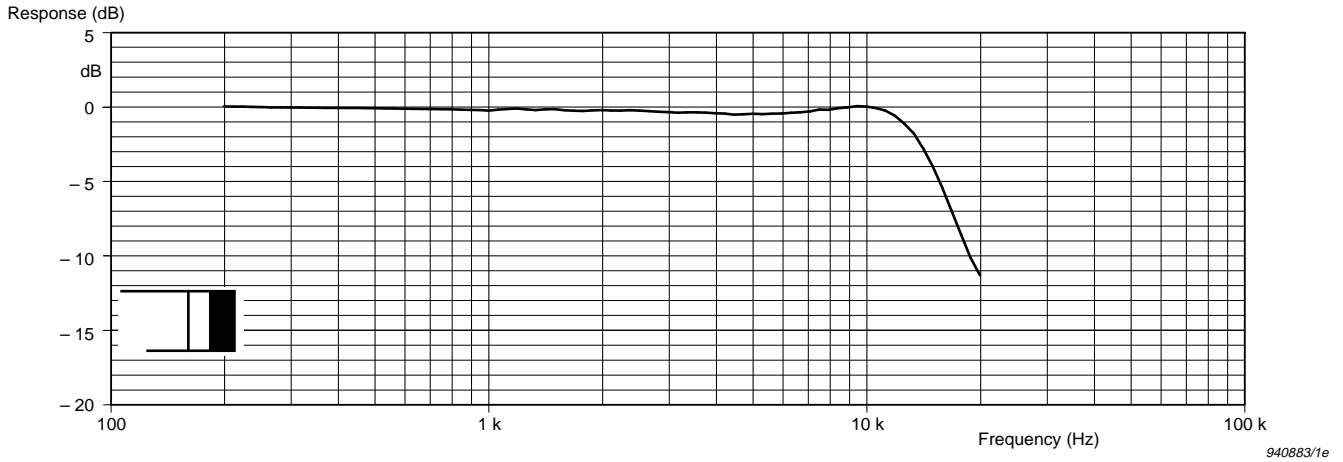
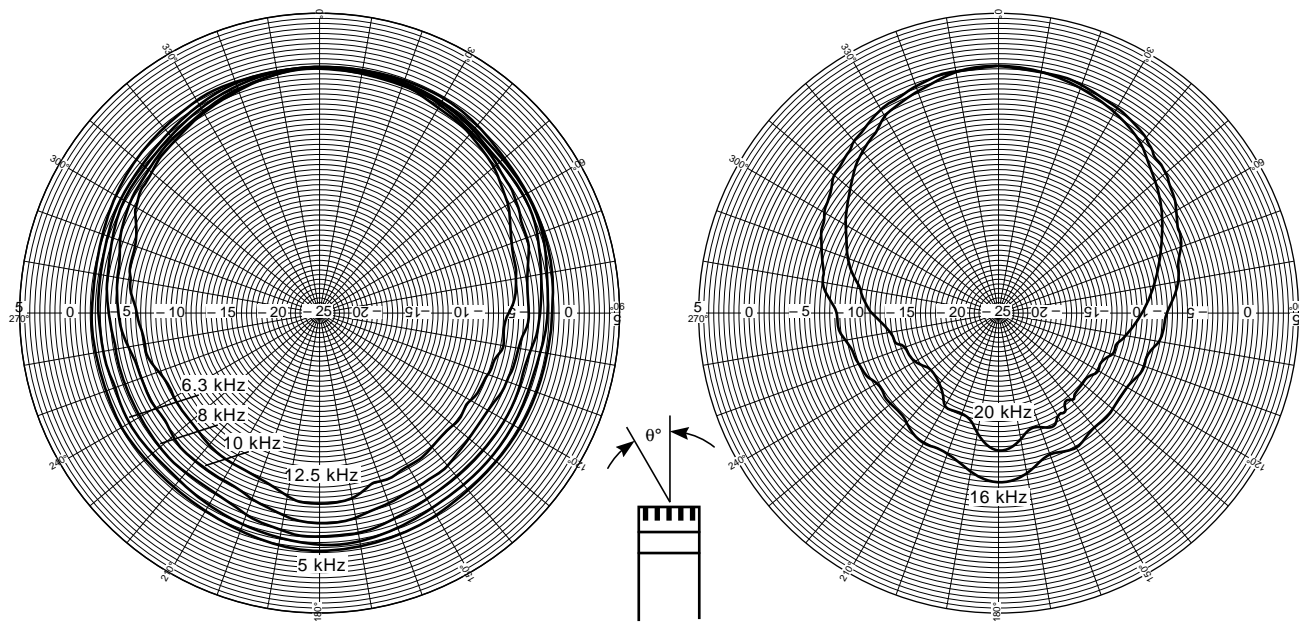

Fig.2.14 Typical random-incidence response for the microphone with Random Incidence Corrector DZ9566

2.4 Directional Characteristics

Typical directional characteristics are given in [Fig.2.15](#) to [Fig.2.17](#). The characteristics are normalised relative to the 0° response.

Note: The non-symmetrical responses are at frequencies outside the microphone's nominal operating range (16 and 20 kHz).



940778e

Fig 2.15 Typical directional characteristics of the microphone with Protection Grid DD 0525

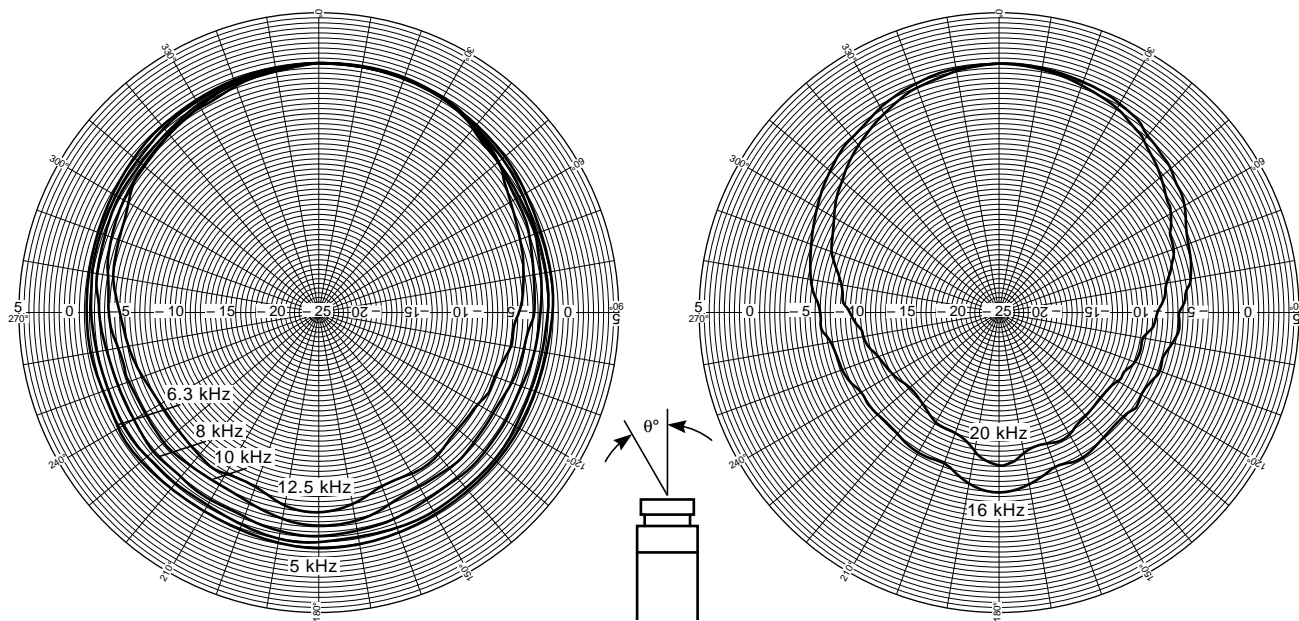

940779e

Fig. 2.16 Typical directional characteristics of the microphone without protection grid

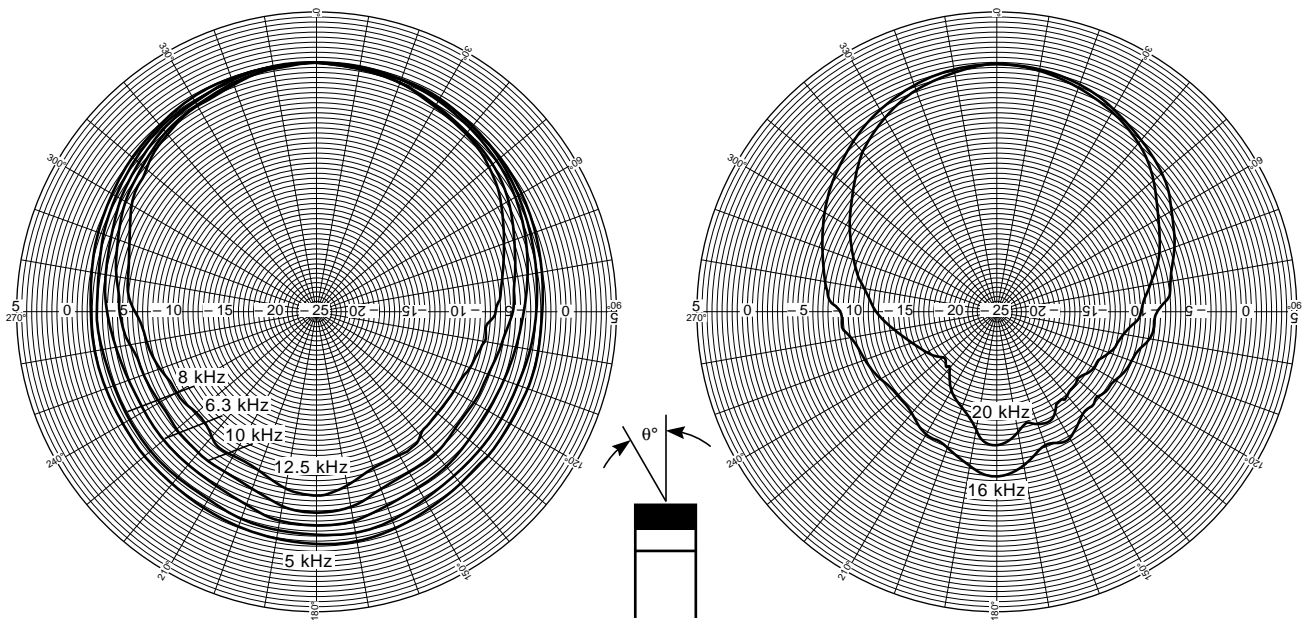

940781e

Fig.2.17 Typical directional characteristics of the microphone with Random Incidence Corrector DZ 9566

2.5 Dynamic Range

Definition

The dynamic range is the range between the upper limit (determined by distortion) and the inherent noise floor. Both limits are influenced by the preamplifier. This section gives values for the microphone with and without a preamplifier.

Inherent Noise

The microphone's inherent noise is due to thermal movements of the diaphragm. These vary proportionally with the square root of the absolute temperature (in °K). The inherent noise increases with increasing temperature. With reference to 20 °C, the inherent noise changes by +0.5 dB at 55 °C and by -0.5 dB at -12 °C. The maximum variation of this noise for different samples of Prepolarized Free-field $\frac{1}{2}$ " Microphone Type 4188 is ± 1 dB.

The preamplifier's effect on the inherent noise of the combined microphone and preamplifier depends on the sensitivity and capacitance of the microphone (for $\frac{1}{2}$ " Microphone Preamplifier Type 2669, see Fig. 2.18 and [Chapter 8](#)).

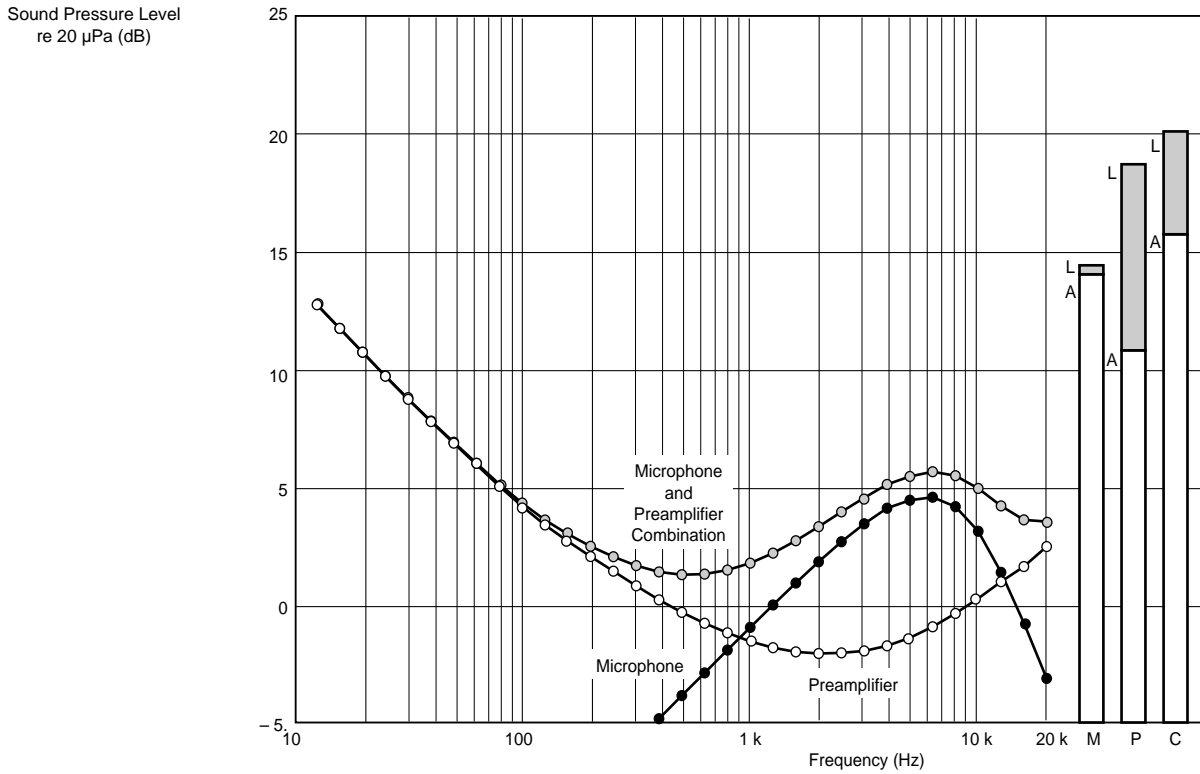

940716e

Fig. 2.18 $\frac{1}{3}$ -octave-band inherent noise spectrum. The shaded bar graphs are the broadband (20Hz to 20kHz) noise levels and the white bar graphs the A-weighted noise levels of the microphone (M), $\frac{1}{2}$ " Microphone Preamplifier Type 2669 (P) and microphone and preamplifier combination (C)

Distortion

The distortion is determined mainly by the microphone but, at the highest operation levels, the preamplifier also contributes to the distortion (see Fig. 2.19).

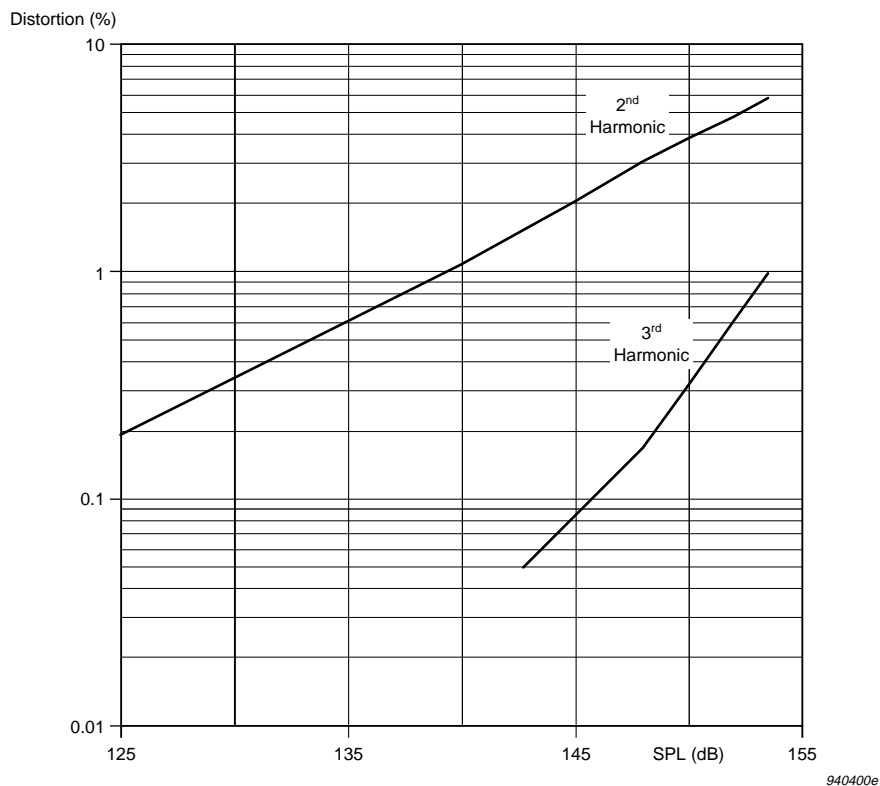

Fig. 2.19 Typical distortion characteristics of the microphone, both open-circuit and with $\frac{1}{2}$ " Microphone Preamplifier Type 2669

The distortion is dependent on the capacitance parallel to the microphone. It increases with increasing capacitance. The distortions given in [Table 2.2](#) and [Table 2.3](#) are valid for a parallel capacitance of 0.5 pF. The distortion is measured at 100 Hz but can be assumed to be valid up to approximately 5 kHz (that is, where the diaphragm displacement is predominantly stiffness-controlled). Distortion measurement methods for higher frequencies are not available.

Maximum Sound Pressure Level

In general, the microphone should not be exposed to sound pressure levels which produce voltages higher than the maximum input voltage specified for the connected preamplifier. After an overload, the preamplifier needs time to recover and, during this recovery period, you cannot measure validly. The maximum input voltage for most Brüel & Kjær preamplifiers is ± 50 V (with a 130 V supply). This voltage is

Lower Limit				Upper Limit	
1 Hz bandwidth at 1 kHz (dB)	1/3-octave band at 1 kHz (dB)	A-weighted (dB)	Linear 20 Hz to 20 kHz (dB)	< 3% distortion (dB)	Max. SPL (Peak) (dB)
-24.5	-0.9	14.2	14.5	146	157

Table 2.2 Dynamic range of the microphone

Lower Limit				Upper Limit	
1 Hz bandwidth at 1 kHz (dB)	1/3-octave band at 1 kHz (dB)	A-weighted (dB)	Linear 20 Hz to 20 kHz (dB)	< 3% distortion (dB)	Max. SPL (Peak) (dB)
-21.7	1.9	15.8	20.1	146	157

Table 2.3 Dynamic range of the microphone with 1/2" Microphone Preamplifier Type 2669

produced by a nominal Prepolarized Free-field 1/2" Microphone Type 4188 at a Peak level of 158 dB (re 20 µPa).

The microphone's distortion increases smoothly as a function of sound pressure level until the diaphragm's displacement becomes so large that it hits the back plate. When this occurs (at a Peak level of 157 dB), the output voltage is clipped. We recommend not to expose Prepolarized Free-field 1/2" Microphone Type 4188 to levels higher than 157 dB (Peak).

2.6 Equivalent Volume and Calibrator Load Volume

Equivalent Volume

For some applications it is practical to express the acoustic impedance of the microphone diaphragm in terms of an equivalent volume. This makes it easier to evaluate the effect of microphone loading on closed cavities or acoustic calibration couplers.

The typical equivalent volume of Prepolarized Free-field 1/2" Microphone Type 4188 is 65 mm³.

Calibrator Load Volume

When the microphone with its protection grid is inserted into the coupler of a calibrator, it will load the calibrator by a volume of 208 mm² at 250 Hz.

Load volume correction to Pistonphone Type 4228 Calibration Level (with Adaptor DP 0776): +0.02 dB

2.7 Capacitance

The microphone's impedance is determined by its capacitance. In addition, the preamplifier's input resistance and capacitance load the microphone. This loading determines the electrical lower limiting frequency and the capacitive input attenuation. However, with modern preamplifiers, this loading is very small and is included in the preamplifier gain, G (see [section 2.2.2](#)). Only in special cases with high capacitive loading does the fall in capacitance with frequency have to be taken into account.

Typical capacitance (at 1000 Hz): 12 pF.

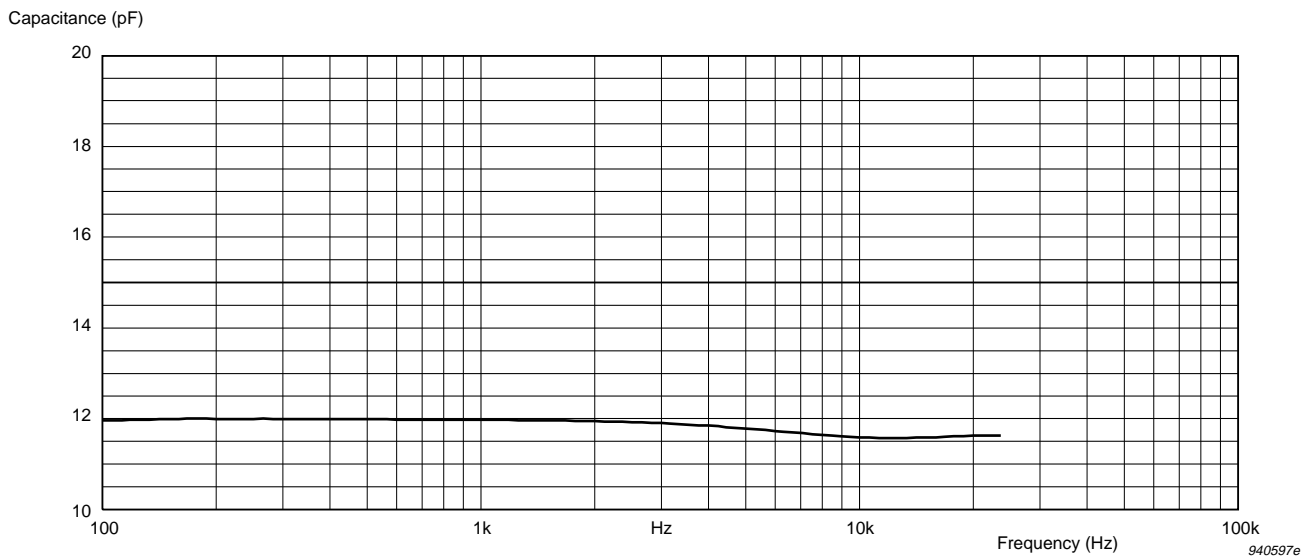

Fig. 2.20 Variation of capacitance with frequency

2.8 Polarization Voltage

The polarization charge of Prepolarized Free-field $\frac{1}{2}$ " Microphone Type 4188 is negative. Therefore, the output voltage is positive for a positive pressure applied to the diaphragm.

At the factory, the microphone is polarized with a permanent charge. Therefore, do not apply an external voltage to the microphone. In order to ensure the correct polarization during use, the centre terminal of the microphone must be kept at the same DC potential as the housing. Therefore, connect the preamplifier pin normally used for the polarization voltage supply to ground potential (0 V). It is not sufficient to leave it open circuit.

Accidentally connecting the microphone to a 200 V external polarization will not damage the microphone. However, the sensitivity will fall by at least 8 dB and the frequency response will change by 1 or 2 dB. We do not recommend use in this way.

Warning! Static electricity can destroy the microphone's built-in charge. Therefore, when mounting the microphone on a preamplifier, the housings of the microphone and preamplifier must be connected before the centre pins make contact. The designs of Brüel & Kjær preamplifiers and sound level meters ensure this.

2.9 Leakage Resistance

The microphone's leakage resistance is greater than $5 \times 10^8 \Omega$ at 90%RH and 23°C.

2.10 Stability

2.10.1 Mechanical Stability

The microphone's design with respect to mechanical stability is improved compared with traditional Brüel & Kjær microphones. The diaphragm clamping ring is less sensitive to accidental force and the protection grid is significantly reinforced. Therefore, the microphone can withstand mechanical shocks better than traditional Brüel & Kjær microphones.

The sensitivity change of the microphone is less than 0.1 dB after a free fall of 1 m onto a solid hardwood block (re IEC 68–2–32).

This improved mechanical stability makes Prepolarized Free-field $\frac{1}{2}$ " Microphone Type 4188 well-suited for surface mounting and for mounting in small couplers as no mechanical adaptor is required to protect the diaphragm clamping ring. The microphone can be supported by the diaphragm clamping ring directly on the coupler's surface. Any force of less than 5 Newtons will cause a change in sensitivity of less than 0.005 dB. This makes the microphone well-suited for fitting in small, plane wave couplers used for reciprocity calibration and any other small coupler with a well-defined volume.

2.10.2 High-temperature Stability

The diaphragm is made of a stainless steel alloy. The alloy has been carefully selected and is very resistant to heat. This means that the diaphragm tension (and therefore the sensitivity) remain the same, even after several hours' operation at high temperature.

The microphone has been tested at temperatures up to 125°C. Below 125°C, no changes occur. At 125°C, the sensitivity can be permanently changed within the first hour by less than 0.1 dB. After this, the sensitivity can be permanently

changed within the next 10 hours by a similar value. These changes are due to decreasing charge of the electret.

Note: Special adaptors (inserted between the microphone and preamplifier) must be made for high-temperature applications in order to protect the preamplifier from heat conduction and radiation.

2.10.3 Long-term Stability

The microphone's long-term stability is determined by the stability of the electret charge. The charge decays very slowly even in humid conditions. See Brüel & Kjær Technical Review no. 4, 1979 and the specifications given below:

- > 1000 years/dB (dry air at 20°C)
- > 10 hours/dB (dry air at 125°C)
- > 40 years/dB (air at 20°C, 90%RH)
- > 6 months/dB (air at 50°C, 90%RH)

2.11 Effect of Temperature

By careful selection of materials, optimization of the design and artificial ageing, the effect of temperature has been made to be very low.

The microphone has been designed to operate at temperatures from -30 to 125°C (70°C with Random Incidence Corrector DZ9566). See [section 2.10.2](#) for permanent changes in sensitivity at temperatures at 125°C .

The reversible changes are shown in [Fig.2.21](#) as a change in sensitivity and in [Fig.2.22](#) and [Fig.2.23](#) as changes in the frequency response normalized at 250 Hz.

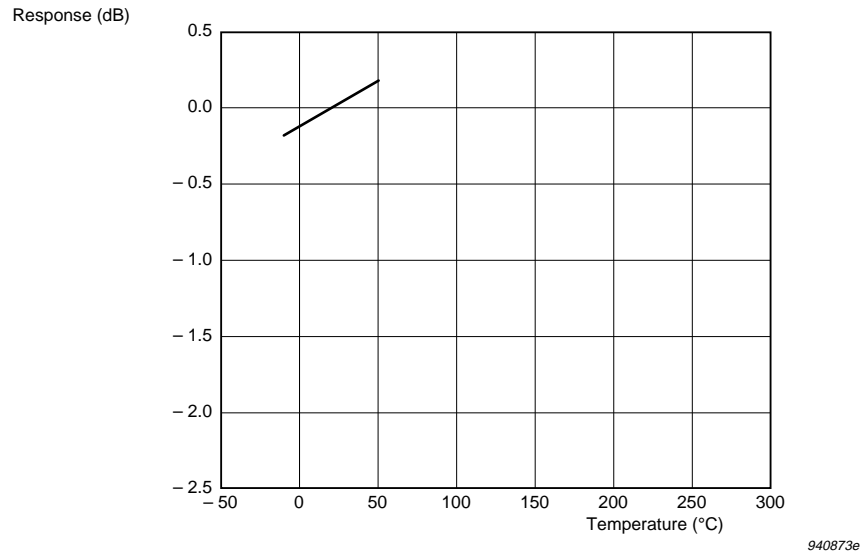

Fig. 2.21 Typical variation in sensitivity (at 250 Hz) as a function of temperature, relative to the sensitivity at 20°C

Temperature Coefficient (1000 Hz):

+0.005 dB/°C, typical (for the range -10 to +50°C)

The effect of temperature on the free-field response (see [Fig.2.23](#)) of the microphone is the sum of the following effects:

- the calculated effect of the change in the speed of sound due to temperature on the 0°-incidence free-field correction
- the measured change in the actuator response due to temperature (see [Fig.2.22](#)).

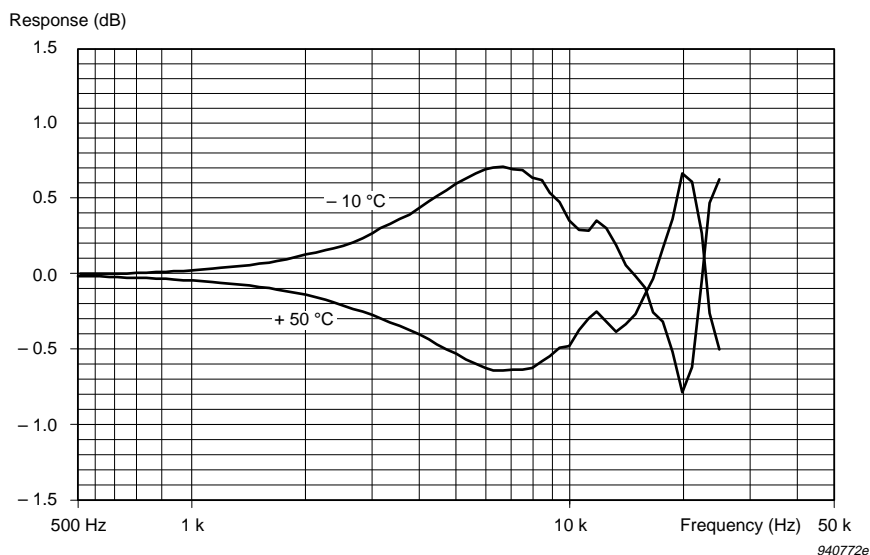

Fig.2.22 Typical variation in actuator response (normalized at 250 Hz) as a function of temperature, relative to the response at 20°C (see Fig.2.4)

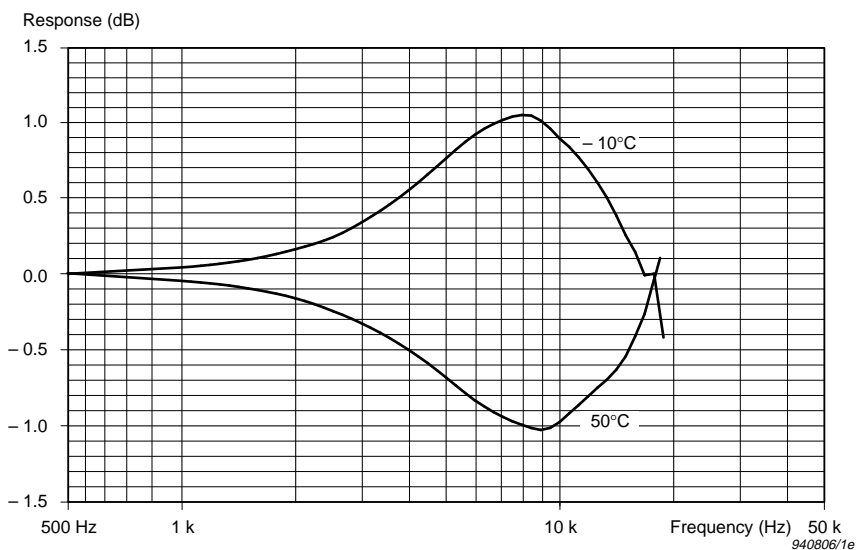

Fig.2.23 Typical variation in 0°-incidence free-field response with Protection Grid DD0525 (normalized at 250 Hz) as a function of temperature, relative to the response at 20°C (see Fig.2.7)

2.12 Effect of Ambient Pressure

The microphone's sensitivity and frequency response are affected by variations in the ambient pressure. This is due to changes in air stiffness in the cavity behind the diaphragm, and changes in air mass in the small gap between the diaphragm and the back plate. The effects are shown in Fig.2.24 to Fig.2.26.

The typical pressure coefficient at 250 Hz for Prepolarized Free-field 1/2" Microphone Type 4188 is -0.021 dB/kPa, well within the ± 0.03 dB/kPa limits required for Type 1 sound level meters by IEC 651.

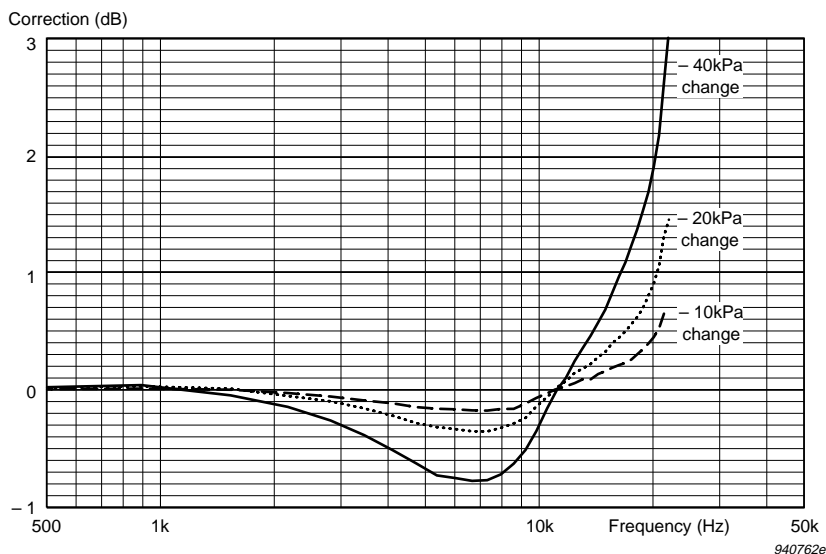

Fig.2.24 Typical variation in frequency response (normalized at 250 Hz) from that at 101.3 kPa as a function of change in ambient pressure

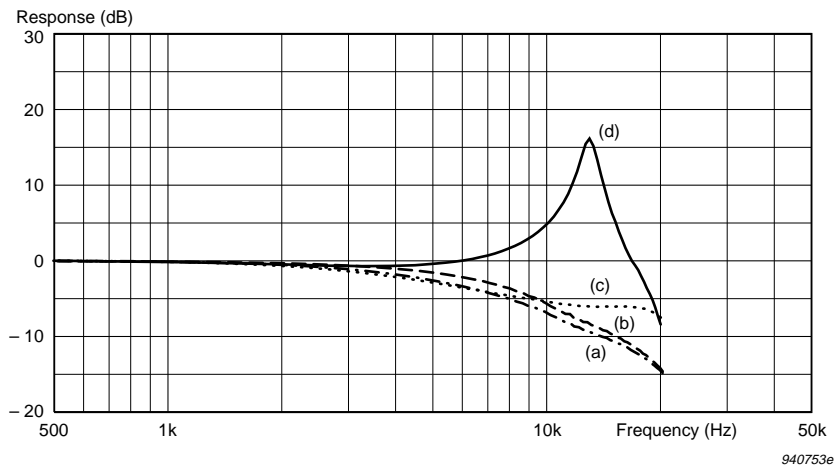

Fig 2.25 Typical effect of ambient pressure on actuator response (a) at 101.3 kPa (b) – 40 kPa change (c) – 80 kPa change (d) at 2 kPa

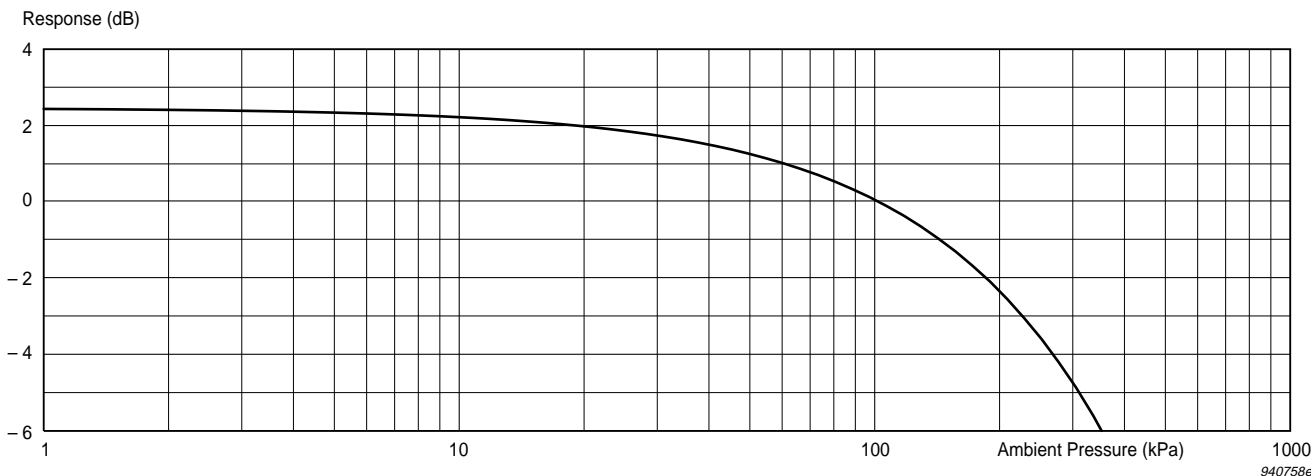

Fig 2.26 Typical variation in sensitivity at 250 Hz from that at 101.3 kPa as a function of ambient pressure

2.13 Effect of Humidity

Due to the microphone's high leakage resistance, humidity has, in general, no effect on the microphone's sensitivity or frequency response. The microphone has been tested according to IEC 68-2-3 and the effects of humidity on the sensitivity at 250 Hz and the frequency response have been found to be less than 0.1 dB at up to 95% RH (non-condensing) and 40°C.

2.14 Effect of Vibration

The effect of vibration is determined mainly by the mass of the diaphragm and is at its maximum for vibrations applied normal to the diaphragm. A vibration signal of 1 m/s^2 RMS normal to the diaphragm typically produces an equivalent Sound Pressure Level of 63.5 dB for a microphone fitted with Protection Grid DD 0525.

2.15 Effect of Magnetic Field

The effect of a magnetic field is determined by the vector field strength and is normally at its maximum when the field direction is normal to the diaphragm. A magnetic field strength of 80 A/m at 50 Hz (the test level recommended by IEC and ANSI) normal to the diaphragm produces a typical equivalent Sound Pressure Level of 7 dB. Higher frequency components in the microphone output become dominant at field strengths greater than 500 to 1000 A/m.

2.16 Electromagnetic Compatibility

See [Chapter 8](#).

2.17 Specifications Overview

<p>OPEN-CIRCUIT SENSITIVITY (1000 Hz)*: −30 dB ±2 dB re 1 V/Pa, 31.6 mV/Pa*</p> <p>POLARIZATION VOLTAGE: External: 0 V</p> <p>FREQUENCY RESPONSE: 0° incidence free-field response: 12.5 Hz to 8 kHz: ±1 dB 8 Hz to 12.5 kHz: ±2 dB In accordance with IEC 651, Type 1 and ANSI S1.4 – 1983</p> <p>LOWER LIMITING FREQUENCY (−3 dB): 1 Hz to 5 Hz (vent exposed to sound)</p> <p>PRESSURE EQUALIZATION VENT: Rear vented</p> <p>DIAPHRAGM RESONANCE FREQUENCY: 9 kHz, typical (90° phase shift)</p> <p>CAPACITANCE (POLARIZED): 12 pF, typical (at 1000 Hz)</p> <p>EQUIVALENT AIR VOLUME (101.3 kPa): 65 mm³</p> <p>_____</p> <p>* Individually calibrated</p>	<p>CALIBRATOR LOAD VOLUME (250 Hz): 208 mm³</p> <p>PISTONPHONE TYPE 4228 CORRECTION: with DP 0776: +0.02 dB</p> <p>TYPICAL CARTRIDGE THERMAL NOISE: 14.2 dB (A) 14.5 dB (Lin.)</p> <p>UPPER LIMIT OF DYNAMIC RANGE: 3% distortion: >146 dB SPL</p> <p>MAXIMUM SOUND PRESSURE LEVEL: 157 dB (peak)</p> <p>OPERATING TEMPERATURE RANGE: −30 to +125°C (−22 to 257°F) Max. 70°C (158°F) when fitted with Random- incidence Corrector DZ 9566</p> <p>OPERATING HUMIDITY RANGE: 0 to 100% RH (without condensation)</p> <p>STORAGE TEMPERATURE: −30 to +70°C (−22 to 158°F)</p> <p>TEMPERATURE COEFFICIENT (250 Hz): +0.005 dB/°C, typical (for the range −10 to +50°C)</p>	<p>PRESSURE COEFFICIENT (250 Hz): −0.021 dB/kPa, typical</p> <p>INFLUENCE OF HUMIDITY: <0.1 dB/100%RH</p> <p>VIBRATION SENSITIVITY (<1000 Hz): Typically 63.5 dB equivalent SPL for 1 m/s² axial acceleration</p> <p>MAGNETIC FIELD SENSITIVITY: Typically 7 dB SPL for 80 A/m, 50 Hz field</p> <p>ESTIMATED LONG-TERM STABILITY: > 1000 years/dB (dry air at 20°C) > 10 hours/dB (dry air at 125°C) > 40 years/dB (air at 20°C, 90% RH) > 6 months/dB (air at 50°C, 90% RH)</p> <p>DIMENSIONS: Diameter: 13.2 mm (0.52 in) (with grid) 12.7 mm (0.50 in) (cartridge housing) 14.35 mm (0.56 in) (with DZ 9566) Height: 14.9 mm (0.59 in) (with grid) 14.0 mm (0.55 in) (without grid) 16.7 mm (0.66 in) (with DZ 9566) Thread for preamplifier mounting: 11.7 mm – 60 UNS</p> <p>The data above are valid at 23°C, 101.3 kPa and 50%RH, unless otherwise specified.</p>
--	---	--

2.18 Ordering Information

Preamplifier

Type 2669: 1/2" Microphone Preamplifier

Type 2671: 1/2" Microphone Preamplifier

Calibration Equipment

Type 4231: Sound Level Calibrator

Type 4226: Multifunction Acoustic Calibrator

Type 4228: Pistonphone

UA 0033: Electrostatic Actuator

Other Accessories

UA 0308: Dehumidifier

UA 0254: Set of 6 Windscreens (UA 0237) 90 mm (3.5 in)

UA 0469: Set of 6 Windscreens (UA 0459) 65 mm (2.6 in)

Chapter 3

Prepolarized Free-field 1/2" Microphone Type 4189

3.1 Introduction

3.1.1 Description



Fig. 3.1 Prepolarized Free-field $\frac{1}{2}$ " Microphone Type 4189 with Protection Grid DB 3420 (included)

Prepolarized Free-field $\frac{1}{2}$ " Microphone Type 4189 is a prepolarized $\frac{1}{2}$ " free-field microphone and offers some significant advantages when used with portable instruments. For example, smaller associated instruments with low power consumption can be used. A general advantage is the improved reliability of the associated preamplifier in humid and polluted atmospheres. These factors make this prepolarized condenser microphone particularly suitable for field measurements, both outdoors and in industrial environments. In addition, it is suited to IEC 651 Type 1 measurements and frequency analysis measurements.

This microphone is polarized by a fixed charge-carrying layer deposited on the backplate. This layer is negatively charged which, at low frequencies, results in a positively increasing output voltage for a positively increasing incident sound pressure. As a prepolarized microphone, it is externally marked by a pair of grooves.

The rugged microphone is built to ensure high stability under a variety of conditions. For example, the stainless steel alloy diaphragm withstands polluted industrial environments. The diaphragm clamping ring is firmly secured to ensure the microphone's reliability, even when the microphone is used without its protection grid. When the microphone is used without its protection grid, it can be easily flush-mounted or inserted into closed volumes as it can be supported by the diaphragm clamping ring, provided that a force of less than 5 Newtons is applied.

The microphone is supplied with individual calibration data on a calibration chart and on a 3 1/2" data disk in a case. This case can also contain a 1/2" Microphone Preamplifier Type 2669.

3.1.2 The Calibration Chart

Each microphone is supplied with an individual calibration chart (see Fig. 3.2) which gives the microphone's open-circuit sensitivity, polarized capacitance and free-field and actuator frequency responses.

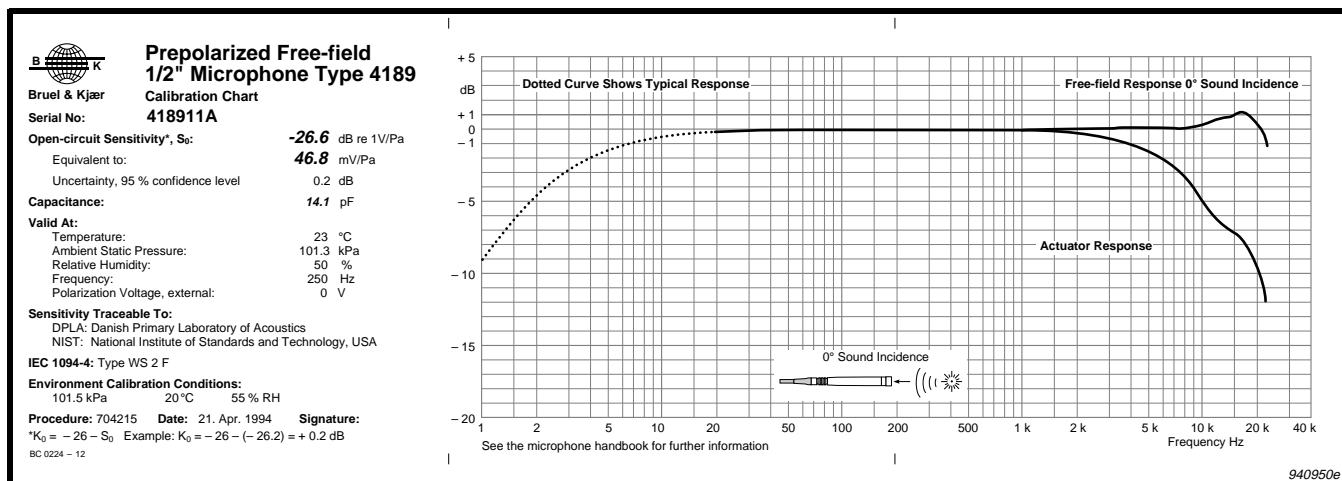

Fig. 3.2 Microphone calibration chart

Open-circuit Sensitivity

The stated open-circuit sensitivity is valid at the reference frequency (251.2 Hz^{*}) for free-field, random-incidence and pressure-field conditions. The stated uncertainty is the U₉₅ value (the value valid for 95% confidence level).

Ambient Conditions

The ambient conditions are measured continuously during calibration at the factory. The calibration results obtained at the measured Environmental Calibration Conditions are corrected to the reference ambient conditions stated under Valid At (23°C, 101.325 kPa and 50% RH).

Frequency Responses

Two individual frequency responses are shown on the calibration chart. Both are normalized to 0 dB at the reference frequency (251.2 Hz^{*}).

*The exact reference frequency is 10^{2.4} Hz (re ISO 266).

The upper curve on the calibration chart is the individual microphone's open-circuit 0°-incidence free-field response. This response is the optimized response for Prepolarized Free-field 1/2" Microphone Type 4189.

The lower curve on the calibration chart is the individual microphone's electrostatic actuator response measured with Electrostatic Actuator UA 0033. This response is used to determine free-field responses at angles of incidence other than 0° and responses in other types of sound field. The individual microphone's electrostatic actuator response is also available on the data disk.

The dotted part of the curve is the typical low-frequency response. Each microphone's individual lower limiting frequency is measured to ensure that it is within the specified tolerances (see Fig. 3.3).

3.1.3 Data Disk

The 3 1/2" data disk supplied with each microphone supplements the calibration chart. It contains individual calibration data and correction curves (see Table 3.1) with a frequency resolution of 1/12-octave as comma-separated ASCII text files under the \DATA directory.

File Name	Content	Frequency Range
S#####.BKM ^a	Sensitivity calibration	251.2 Hz
A#####.BKM ^a	Actuator response	200 Hz – 22 kHz
F#####.BKR ^b	Free-field response	1 Hz – 22 kHz
4189L.BKT ^c	Low-frequency response	1 Hz – 190 Hz
4189F.BKC ^d	Free-field corrections without protection grid	200 Hz – 22 kHz
4189FG.BKC ^d	Free-field corrections with protection grid	200 Hz – 22 kHz
4189R.BKC ^d	Random-incidence corrections without protection grid	200 Hz – 22 kHz
4189RG.BKC ^d	Random-incidence corrections with protection grid	200 Hz – 22 kHz
4189P.BKC ^d	Pressure-field corrections	200 Hz – 22 kHz

Table 3.1 Calibration data and corrections contained on the data disk. Note: ##### is the microphone's serial number

a. Individual calibration data (measured).

b. Low-frequency response combined with actuator response and free-field corrections.

c. Typical response for Prepolarized Free-field 1/2" Microphone Type 4189.

d. Corrections for Prepolarized Free-field 1/2" Microphone Type 4189.

These text files can be viewed on Microsoft® Windows™ using the Brüel & Kjær Microphone Viewer program (BK-MIC.EXE) supplied on the disk. They can also be accessed by a suitable spreadsheet for further processing or printing.

Brüel & Kjær Microphone Viewer must be installed before use (see [section 1.3.5](#)).

3.1.4 Recommended Recalibration Interval

With normal handling of the microphone and any associated instrument, Brüel & Kjær recommends that the microphone be recalibrated every 2 years.

Prepolarized Free-field 1/2" Microphone Type 4189 is very stable over this period (see [section 3.10](#) to [section 3.12](#)). Improper handling is by far the most likely cause of change in the microphone's properties. Any damage which causes improper operation can probably be detected using a sound level calibrator. In many cases, the damage can be seen by carefully inspecting the protection grid and diaphragm.

3.2 Sensitivity

3.2.1 Open-circuit Sensitivity

The open-circuit sensitivity is defined as the sensitivity of the microphone when not loaded by the input impedance of the connected preamplifier (the termination is described in IEC 1094-2). The sensitivity is measured for the individual microphone at 251.2 Hz and stated on the microphone's calibration chart (see [section 3.1.2](#)) and data disk (see [section 3.1.3](#)). The nominal sensitivity is shown in [Table 3.2](#).

Nominal open-circuit sensitivity		Accepted Deviation (dB)
mV/Pa	dB re 1 V/Pa	
50	-26	±1.5

Table 3.2 Nominal open-circuit sensitivity

3.2.2 Loaded Sensitivity

When loaded by a preamplifier, the sensitivity of the microphone is given by:

$$S_C = S_O + G \quad (3.1)$$

where S_C = overall sensitivity of microphone and preamplifier combination
 S_O = open-circuit sensitivity of microphone
 G = voltage gain of microphone and preamplifier combination (in dB)

With Microphone Preamplifier Type 2639: $G = -0.1$ dB

With 1/2" Microphone Preamplifier Type 2669: $G = -0.25$ dB

Example

Loaded sensitivity of typical microphone with 1/2" Microphone Preamplifier Type 2669:

$$S_C = -26.3 + (-0.25) = -26.55 \text{ dB}$$

3.2.3 K-factor

Some types of Brüel & Kjær instruments use the K-factor (correction factor) or the K_O -factor (open-circuit correction factor) for calibration.

$$K = -26 - S_C \quad (3.2)$$

$$K_O = -26 - S_O \quad (3.3)$$

Example

Correction factor for typical microphone with 1/2" Microphone Preamplifier Type 2669:

$$K = -26 - (-26.55) = +0.55 \text{ dB}$$

Open-circuit correction factor for typical microphone with 1/2" Microphone Preamplifier Type 2669:

$$K_O = -26 - (-26.3) = +0.3 \text{ dB}$$

3.3 Frequency Response

3.3.1 General

In acoustic measurements, there are three types of sound field:

- Free field
- Pressure field
- Diffuse field

The microphone is optimized to have a flat frequency response in one of these sound fields. This response is called the optimized response. A microphone's response in a diffuse field is equivalent to its random-incidence response.

This section shows the microphone's typical free-field, pressure-field and random-incidence responses together with the microphone's typical actuator response obtained using Electrostatic Actuator UA 0033. The low-frequency response described in [section 3.3.4](#) is common for all types of response.

All frequency responses and correction curves are shown with a frequency resolution of $\frac{1}{12}$ -octave.

3.3.2 Optimized Response (0° -incidence Free-field Response)

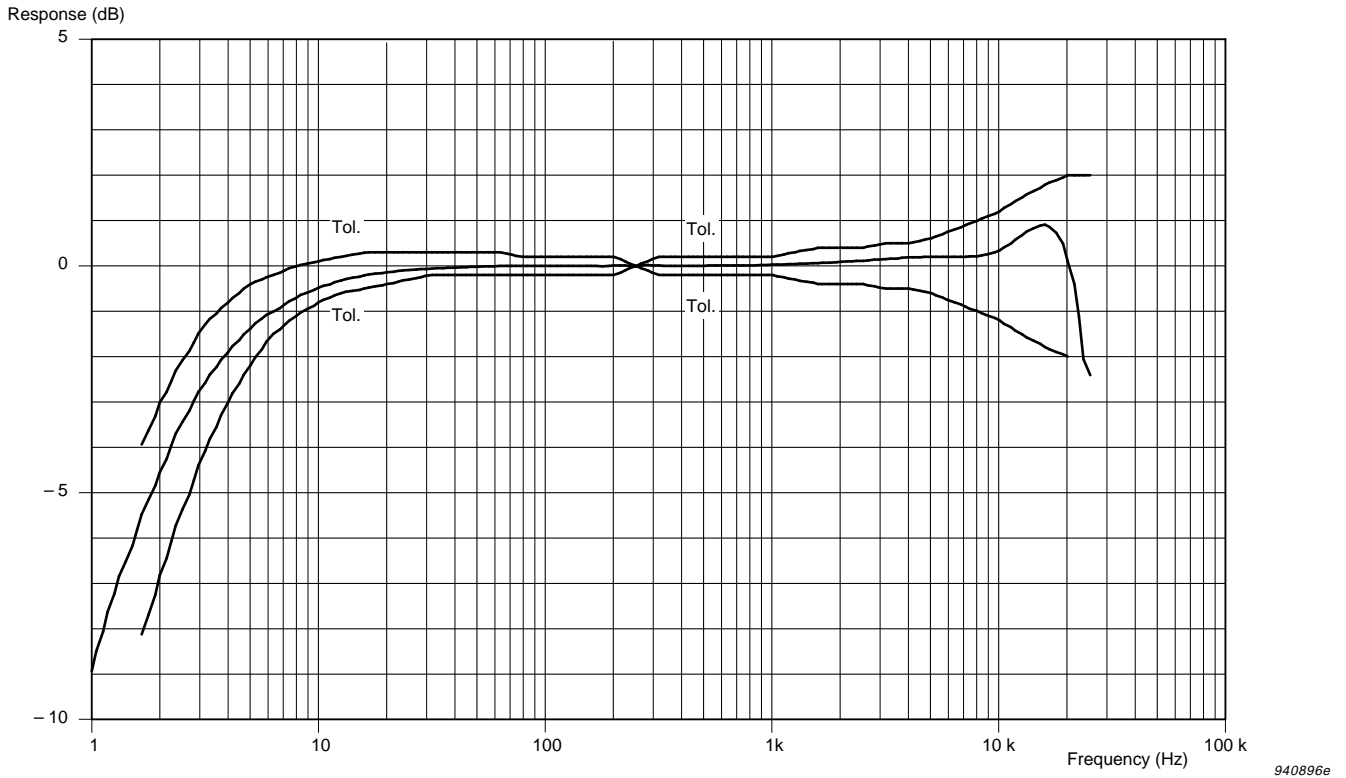

Fig. 3.3 Typical free-field response of the microphone with Protection Grid DB 3420 and the microphone's specified tolerances. The low-frequency response is valid when the vent is exposed to the sound field

The frequency response of Prepolarized Free-field $\frac{1}{2}$ " Microphone Type 4189 meets the requirements of IEC 651 Type 1.

3.3.3 Actuator Response

The microphone's frequency response is determined by adding corrections for the type of sound field to its actuator response obtained using Electrostatic Actuator

UA 0033. This is a reproducible and practical method for calibrating a microphone's frequency response.

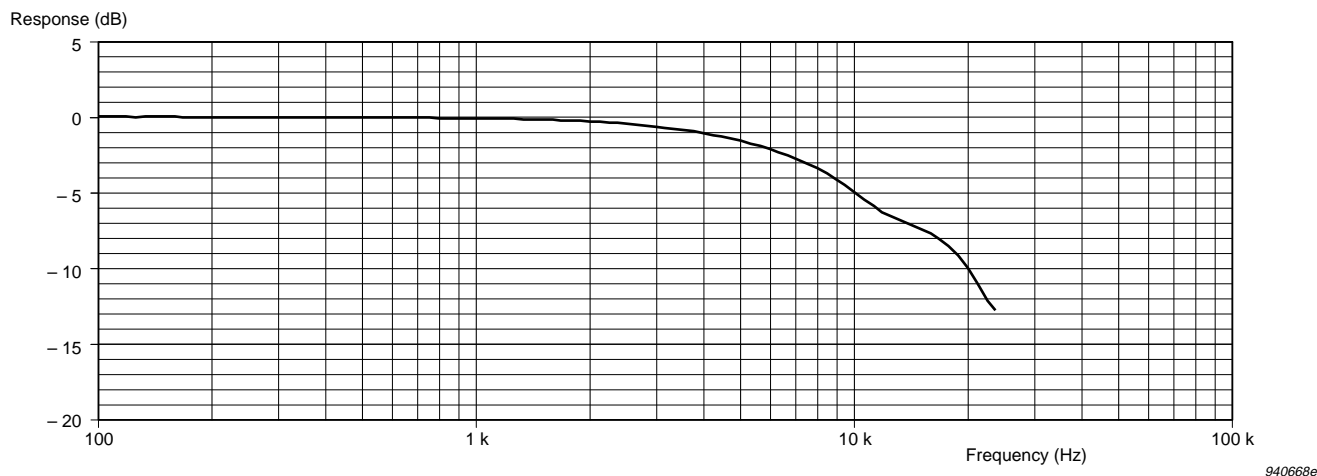

Fig. 3.4 Typical actuator response (magnitude) measured with Electrostatic Actuator UA 0033

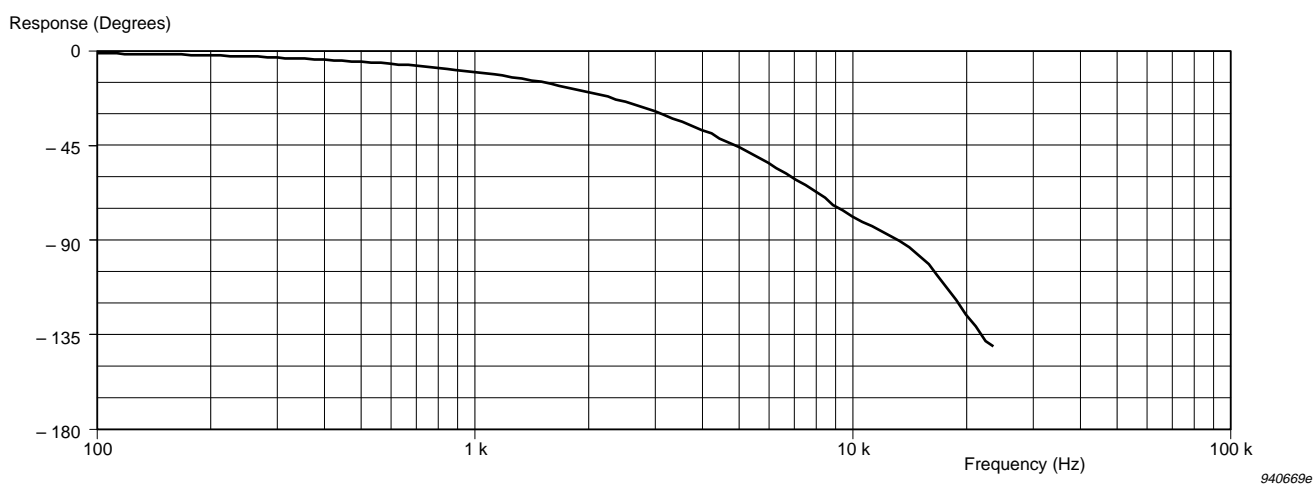

Fig. 3.5 Typical actuator response (phase) measured with Electrostatic Actuator UA 0033

This microphone is polarized by a fixed charge-carrying layer deposited on the backplate. This layer is negatively charged which, at low frequencies, results in a positively increasing output voltage for a positively increasing incident sound pressure.

3.3.4 Low-frequency Response

The low-frequency response (see Fig 3.3) is the typical response with the vent exposed to the sound field. If the vent is not exposed to the sound field, the sensitivity

increases from 0 dB at the reference frequency (251.2 Hz) to approximately 0.3 dB at 1 Hz.

For applications where the vent is not exposed to the sound field, take care to ensure proper static pressure equalization to prevent static displacement of the diaphragm.

The microphone's low-frequency response is common for all types of sound field.

The microphone's lower limiting frequency (-3 dB) is between 2 and 4 Hz with the vent exposed to the sound field. This is measured during production to ensure that specifications are fulfilled.

3.3.5 Free-field Response

The microphone's free-field correction curves are shown in [Fig. 3.6](#) and [Fig. 3.8](#). These corrections are added to the microphone's actuator response obtained using Electrostatic Actuator UA 0033 in order to determine the free-field response at any angle of incidence. The typical free-field response at 0° incidence with and without the protection grid are shown in [Fig. 3.7](#) and [Fig. 3.9](#).

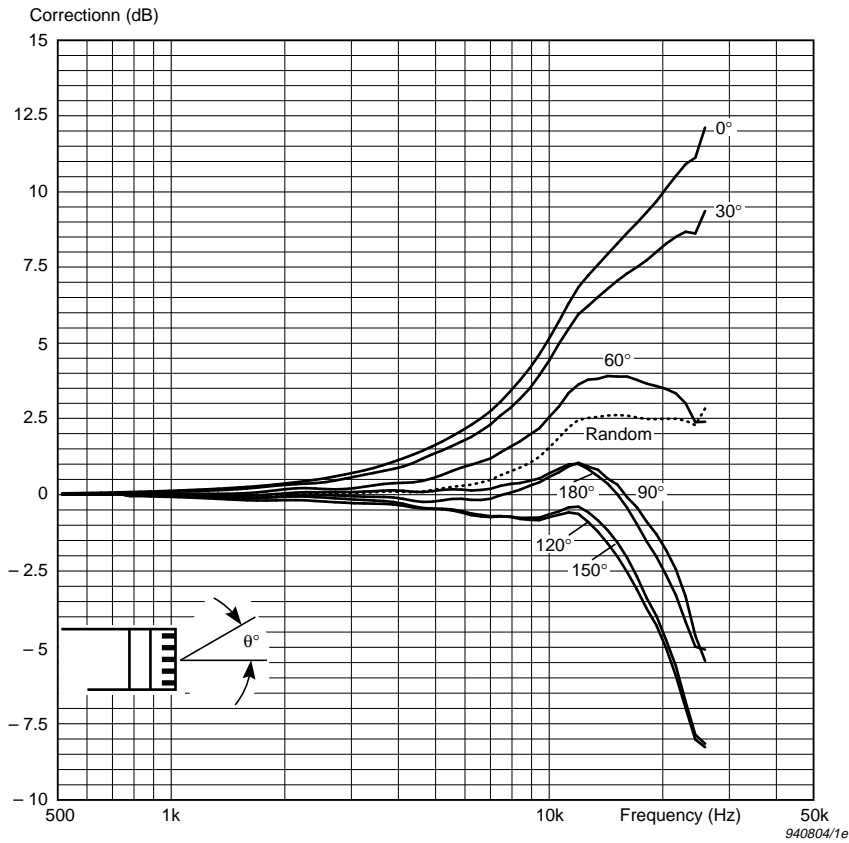

Fig.3.6 Free-field correction curves for the microphone with Protection Grid DB 3420

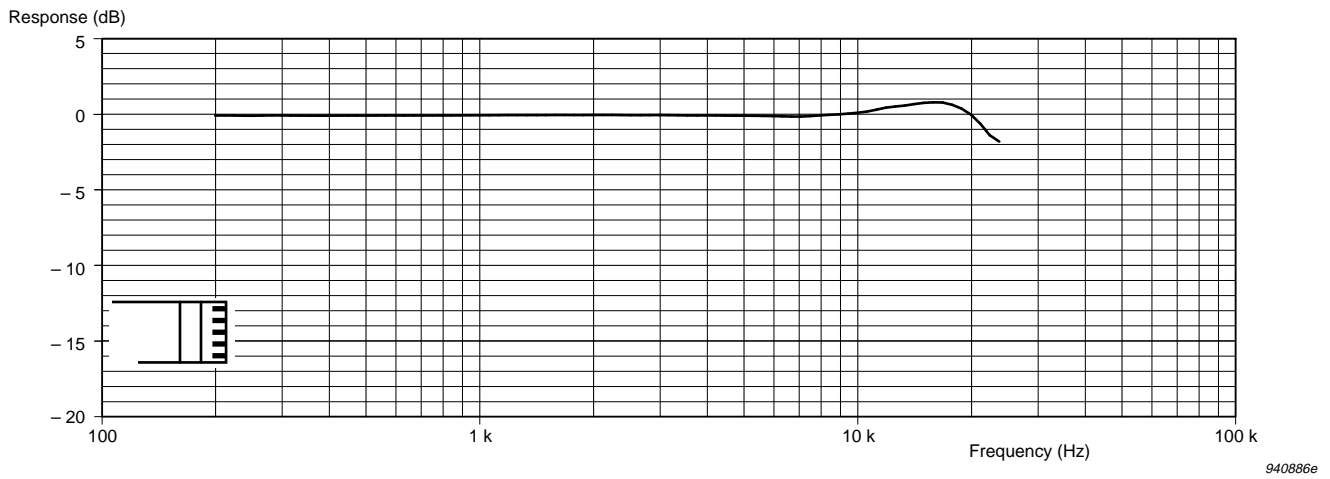

Fig.3.7 Typical free-field response (0° incidence) for the microphone with Protection Grid DB 3420

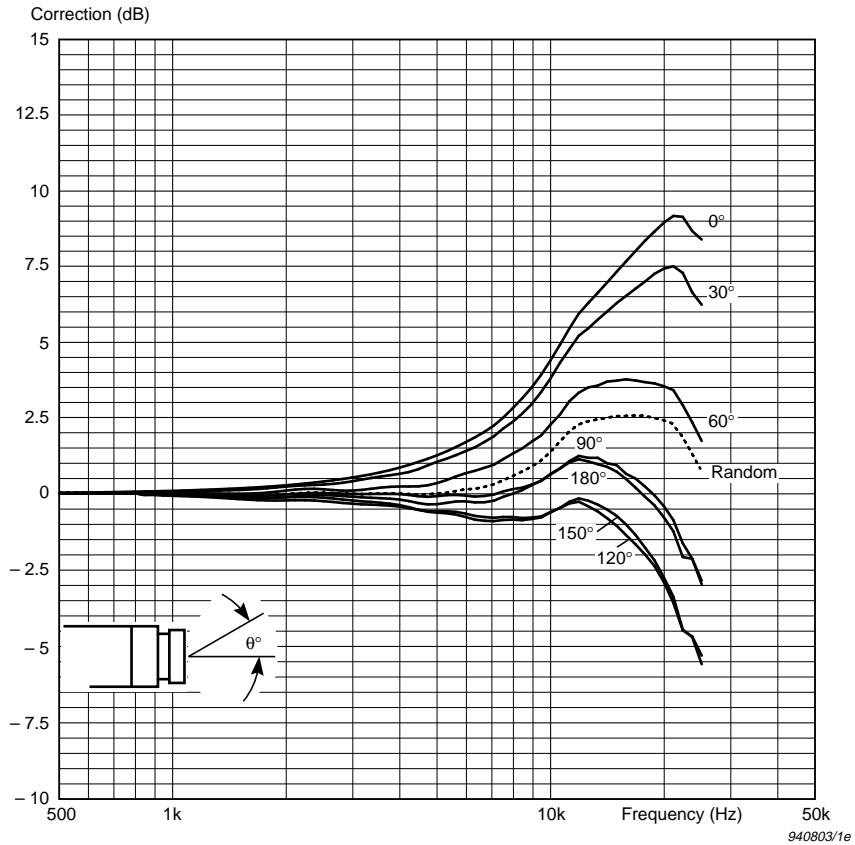

Fig. 3.8 Free-field correction curves for the microphone without protection grid

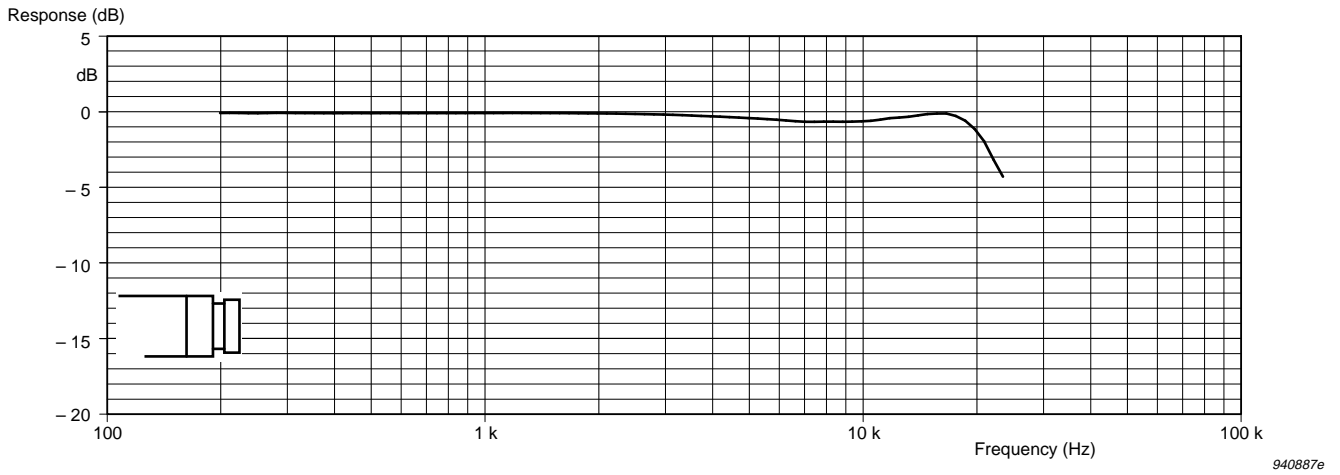

Fig. 3.9 Typical free-field response (0° incidence) for the microphone without protection grid

3.3.6 Random-incidence Response

A microphone's response in a diffuse sound field is equivalent to its random-incidence response. The microphone's random-incidence correction curves are shown in Fig. 3.6 and Fig. 3.8. These corrections are added to the microphone's actuator response obtained using Electrostatic Actuator UA 0033 in order to determine the random-incidence response. The typical random-incidence response with and without the protection grid are shown in Fig. 3.10 and Fig. 3.11.

The random-incidence corrections are calculated from the free-field corrections measured in 5° steps according to Draft IEC 1183–1993.

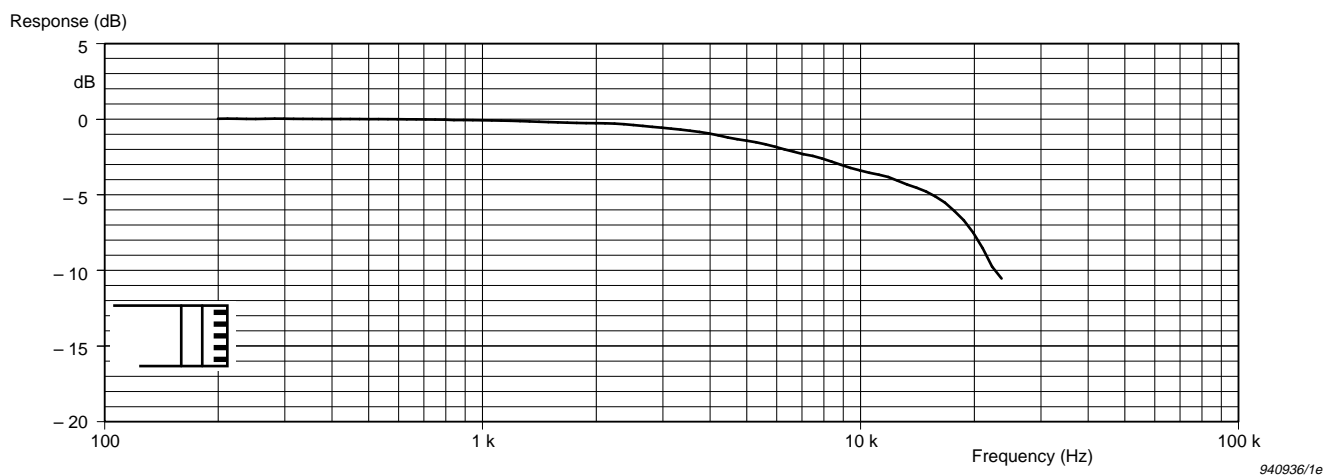

Fig. 3.10 Typical random-incidence response for the microphone with Protection Grid DB 3420

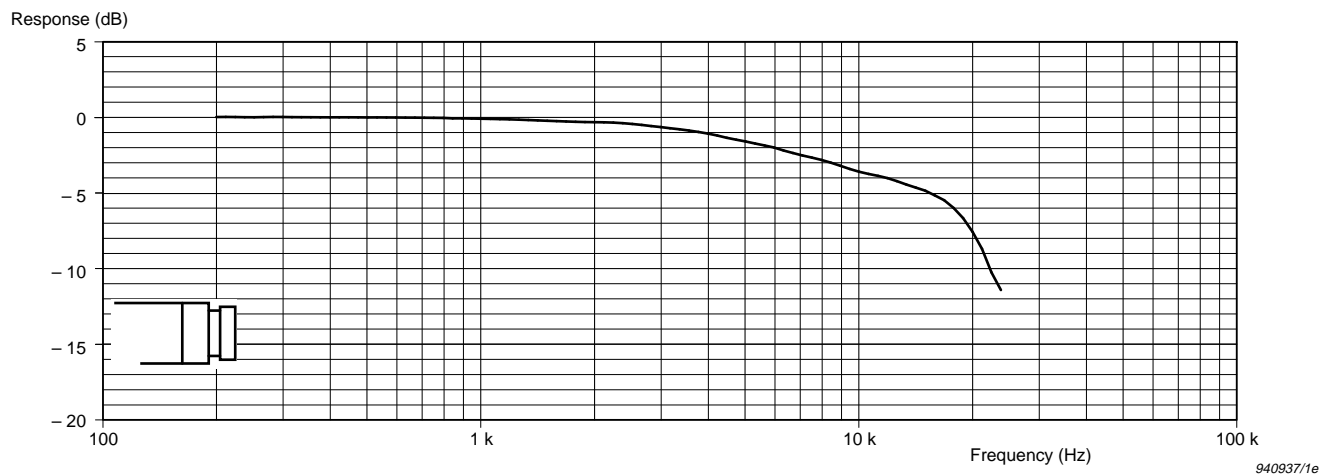

Fig. 3.11 Typical random-incidence response for the microphone without protection grid

3.3.7 Pressure-field Response

The microphone's pressure-field correction curve is shown in Fig.3.12. This correction is added to the microphone's actuator response obtained using Electrostatic Actuator UA 0033 in order to determine the pressure-field response. The typical pressure-field response is shown in Fig.3.13.

In practice, the pressure-field response is often regarded as being equal to the actuator response as the difference between them is small compared to the uncertainty related to many types of measurement.

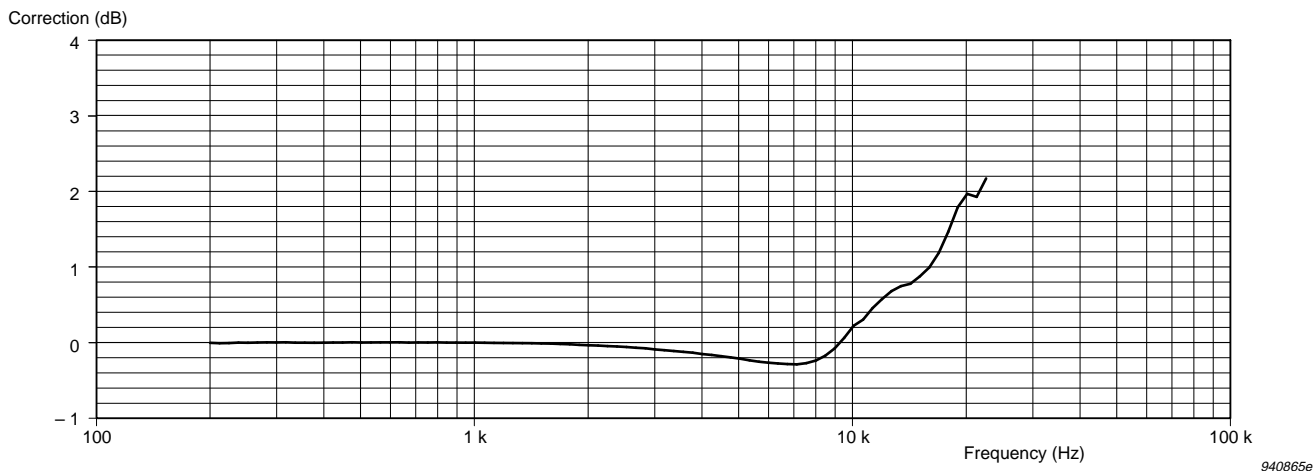

Fig. 3.12 Pressure-field correction for the microphone

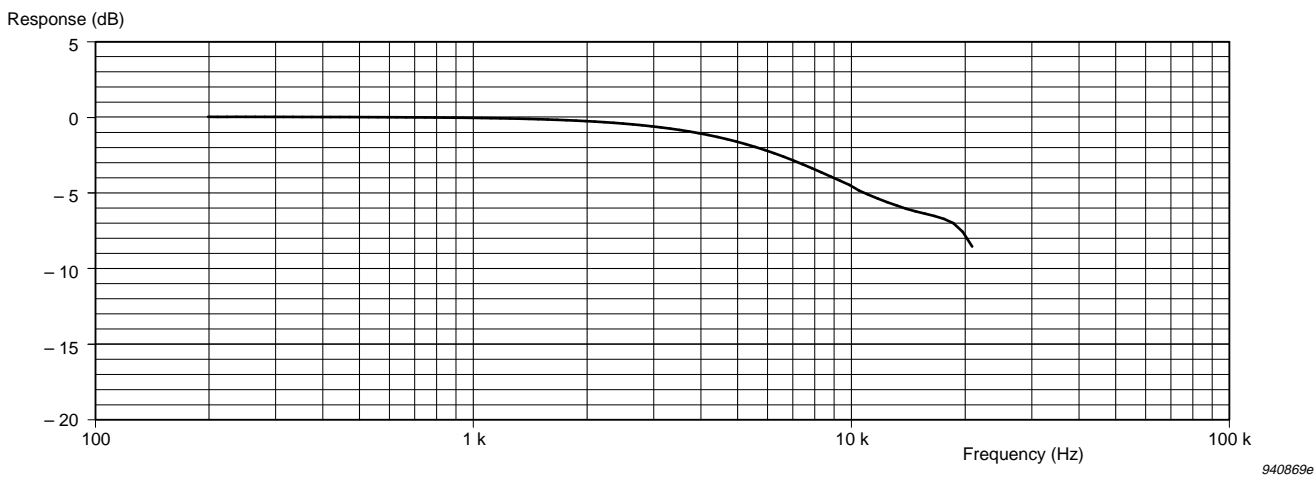
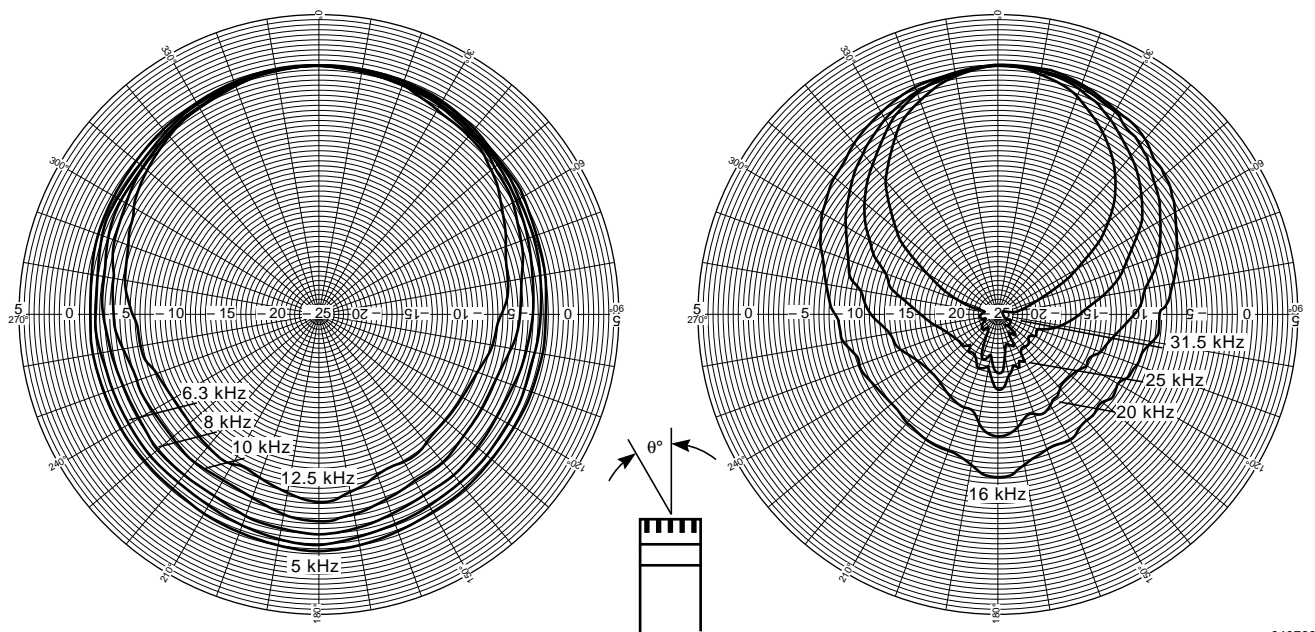

Fig. 3.13 Typical pressure-field response for the microphone

3.4 Directional Characteristics

Typical directional characteristics are given in Fig. 3.14 and Fig. 3.15. The characteristics are normalised relative to the 0° response.



940786e

Fig. 3.14 Typical directional characteristics of the microphone with Protection Grid DB 3420

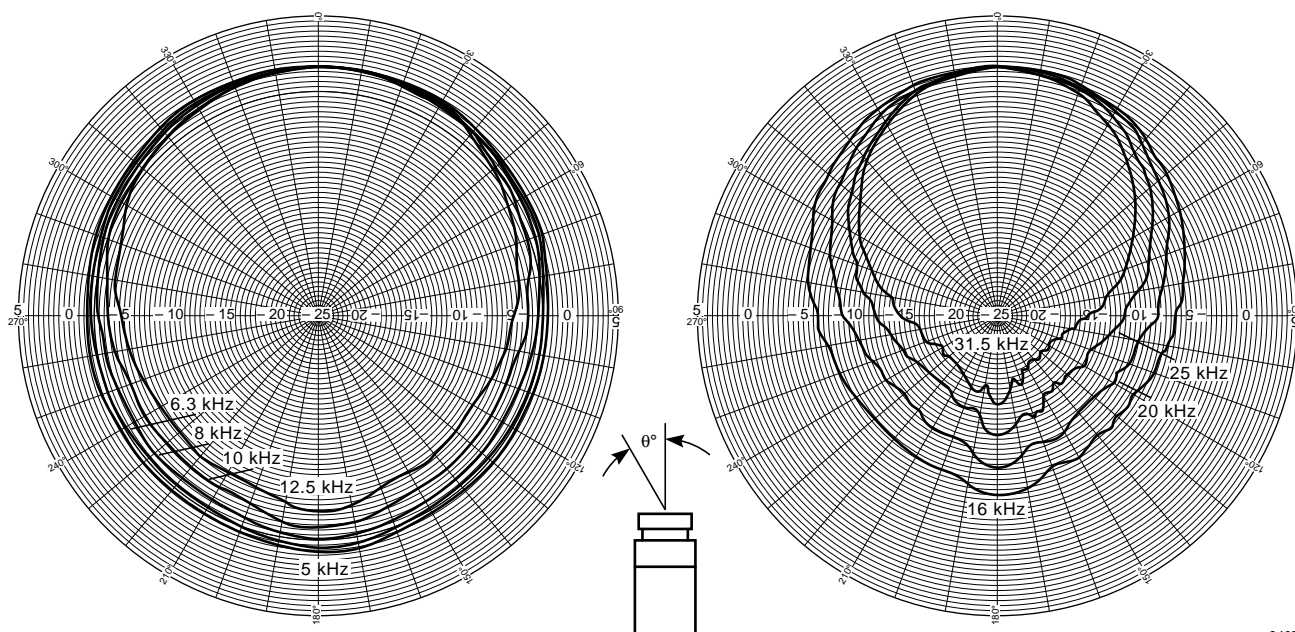

940783e

Fig. 3.15 Typical directional characteristics of the microphone without protection grid

3.5 Dynamic Range

Definition

The dynamic range is the range between the upper limit (determined by distortion) and the inherent noise floor. Both limits are influenced by the preamplifier. This section gives values for the microphone with and without a preamplifier.

Inherent Noise

The microphone's inherent noise is due to thermal movements of the diaphragm. These vary proportionally with the square root of the absolute temperature (in °K). The inherent noise increases with increasing temperature. With reference to 20 °C, the inherent noise changes by +0.5 dB at 55 °C and by -0.5 dB at -12 °C. The maximum variation of this noise for different samples of Prepolarized Free-field $\frac{1}{2}$ " Microphone Type 4189 is ± 1 dB.

The preamplifier's effect on the inherent noise of the combined microphone and preamplifier depends on the sensitivity and capacitance of the microphone (for 1/2" Microphone Preamplifier Type 2669, see Fig. 3.16 and Chapter 8).

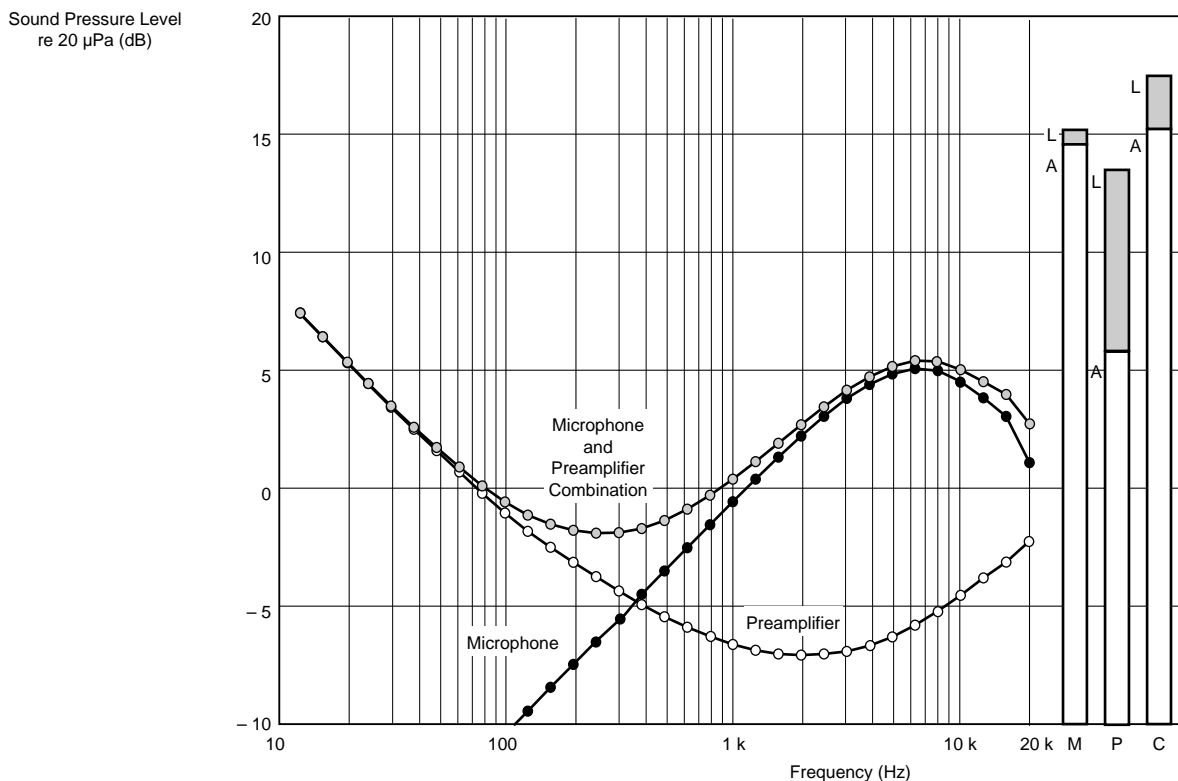

940717e

Fig. 3.16 1/3-octave-band inherent noise spectrum. The shaded bar graphs are the broadband (20 Hz to 20 kHz) noise levels and the white bar graphs the A-weighted noise levels of the microphone (M), 1/2" Microphone Preamplifier Type 2669 (P) and microphone and preamplifier combination (C)

Distortion

The distortion is determined mainly by the microphone but, at the highest operation levels, the preamplifier also contributes to the distortion (see Fig. 3.17).

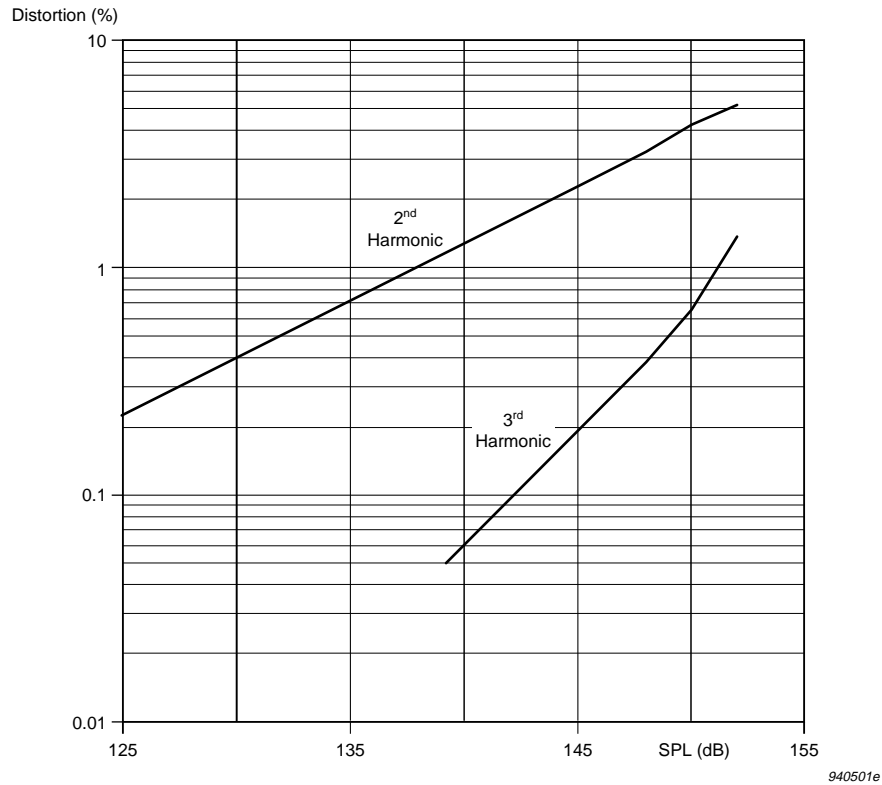

Fig. 3.17 Typical distortion characteristics of Prepolarized Free-field $\frac{1}{2}$ " Microphone Type 4189

The distortion is dependent on the capacitance parallel to the microphone. It increases with increasing capacitance. The distortions given in Table 3.3 and Table 3.4 are valid for a parallel capacitance of 0.5 pF. The distortion is measured at 100 Hz but can be assumed to be valid up to approximately 5 kHz (that is, where the diaphragm displacement is predominantly stiffness-controlled). Distortion measurement methods for higher frequencies are not available.

Maximum Sound Pressure Level

In general, the microphone should not be exposed to sound pressure levels which produce voltages higher than the maximum input voltage specified for the connected preamplifier. After an overload, the preamplifier needs time to recover and, during this recovery period, you cannot measure validly. The maximum input voltage for most Brüel & Kjær preamplifiers is ± 50 V (with a 130 V supply). This voltage is

Lower Limit				Upper Limit	
1 Hz bandwidth at 1 kHz (dB)	1/3-octave at 1 kHz (dB)	A-weighted (dB)	Linear 20 Hz to 20 kHz (dB)	< 3% distortion (dB)	Max. SPL (Peak) (dB)
-24.3	-0.7	14.6	15.3	146	158

Table 3.3 Dynamic range of the microphone

Lower Limit				Upper Limit	
1 Hz bandwidth at 1 kHz (dB)	1/3-octave at 1 kHz (dB)	A-weighted (dB)	Linear 20 Hz to 20 kHz (dB)	< 3% distortion (dB)	Max. SPL (Peak) (dB)
-23.2	0.4	15.2	17.4	146	158

Table 3.4 Dynamic range of the microphone with 1/2" Microphone Preamplifier Type 2669

produced by a nominal Prepolarized Free-field 1/2" Microphone Type 4189 at a Peak level of 154 dB (re 20 µPa).

The microphone's distortion increases smoothly as a function of sound pressure level until the diaphragm's displacement becomes so large that it hits the back plate. When this occurs (at a Peak level of 158 dB), the output voltage is clipped. We recommend not to expose Prepolarized Free-field 1/2" Microphone Type 4189 to levels higher than 158 dB (Peak).

3.6 Equivalent Volume and Calibrator Load Volume

Equivalent Volume

For some applications it is practical to express the acoustic impedance of the microphone diaphragm in terms of a complex equivalent volume. This makes it easier to evaluate the effect of microphone loading on closed cavities or acoustic calibration couplers.

The real and imaginary parts of the equivalent volume shown in [Fig 3.18](#) are in parallel. They are calculated from a simple R-L-C series model of the microphone which gives the best overall approximation of the microphone's diaphragm impedance.

The Models

The following equivalent models are valid at 101.325 kPa, 23 °C and 50%RH:

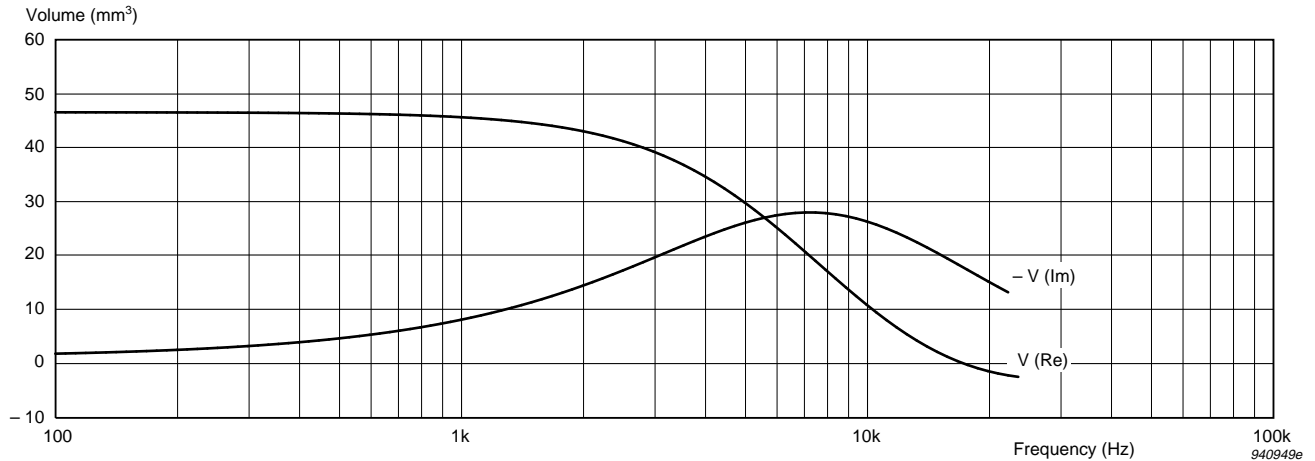

Fig 3.18 Typical equivalent volume (real and imaginary parts) based on mathematical model of microphone

Model 1

$$C = 0.324 \times 10^{-12} \text{m}^5/\text{N}$$

$$L = 305 \text{kg/m}^4$$

$$R = 77 \times 10^6 \text{Ns/m}^5$$

where C = acoustic diaphragm compliance
 L = acoustic diaphragm mass
 R = acoustic diaphragm damping resistance

Model 2

$$V_{lf} = 46 \text{mm}^3$$

$$f_0 = 16 \text{kHz}$$

$$Q = 0.4$$

where V_{lf} = low-frequency volume
 f_0 = diaphragm resonance frequency
 Q = quality factor

Calibrator Load Volume

When the microphone with its protection grid is inserted into the coupler of a calibrator, it will load the calibrator by a volume of 260mm^3 at 250 Hz.

Load volume correction to Pistonphone Type 4228 Calibration Level (with Adaptor DP 0776): 0.00 dB

3.7 Capacitance

The microphone's impedance is determined by its capacitance. In addition, the preamplifier's input resistance and capacitance load the microphone. This loading determines the electrical lower limiting frequency and the capacitive input attenuation. However, with modern preamplifiers, this loading is very small and is included in the preamplifier gain, G (see [section 3.2.2](#)). Only in special cases with high capacitive loading does the fall in capacitance with frequency have to be taken into account.

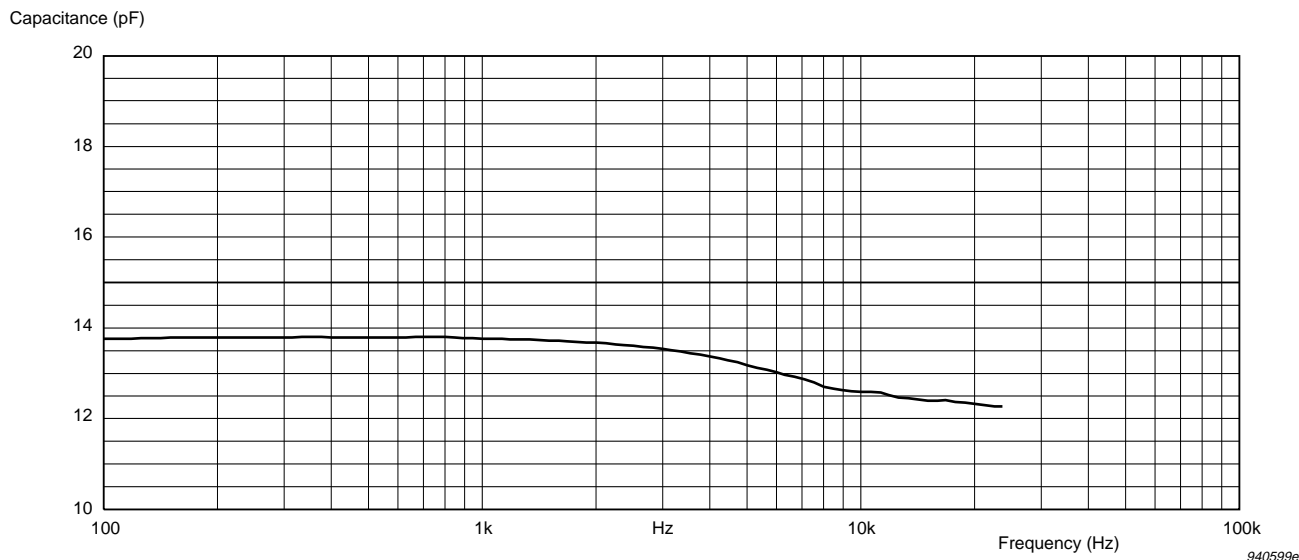

Fig. 3.19 Variation of capacitance with frequency

Typical capacitance (at 250 Hz): 14 pF.

The capacitance is individually calibrated and stated on the calibration chart.

3.8 Polarization Voltage

The polarization charge of Prepolarized Free-field 1/2" Microphone Type 4189 is negative. Therefore, the output voltage is positive for a positive pressure applied to the diaphragm.

At the factory, the microphone is polarized with a permanent charge. Therefore, do not apply an external voltage to the microphone. In order to ensure the correct polarization during use, the centre terminal of the microphone must be kept at the same DC potential as the housing. Therefore, connect the preamplifier pin normally used for the polarization voltage supply to ground potential (0 V). It is not sufficient to leave it open circuit.

Accidentally connecting the microphone to a 200 V external polarization will not damage the microphone. However, the sensitivity will fall by at least 8 dB and the frequency response will change by 1 or 2 dB. We do not recommend use in this way.

Warning! Static electricity can destroy the microphone's built-in charge. Therefore, when mounting the microphone on a preamplifier, the housings of the microphone and preamplifier must be connected before the centre pins make contact. The designs of Brüel & Kjær preamplifiers and sound level meters ensure this.

3.9 Leakage Resistance

The microphone's leakage resistance is greater than $5 \times 10^{13} \Omega$ at 90%RH and 23°C.

3.10 Stability

3.10.1 Mechanical Stability

The microphone's design with respect to mechanical stability is improved compared with traditional Brüel & Kjær microphones. The diaphragm clamping ring is less sensitive to accidental force and the protection grid is significantly reinforced. Therefore, the microphone can withstand mechanical shocks better than traditional Brüel & Kjær microphones.

The sensitivity change of the microphone is less than 0.1 dB after a free fall of 1 m onto a solid hardwood block (re IEC 68-2-32).

This improved mechanical stability makes Prepolarized Free-field $\frac{1}{2}$ " Microphone Type 4189 well-suited for surface mounting and for mounting in small couplers as no mechanical adaptor is required to protect the diaphragm clamping ring. The microphone can be supported by the diaphragm clamping ring directly on the coupler's surface. Any force of less than 5 Newtons will cause a change in sensitivity of less than 0.005 dB. This makes the microphone well-suited for fitting in small, plane wave couplers used for reciprocity calibration and any other small coupler with a well-defined volume.

3.10.2 High-temperature Stability

The diaphragm is made of a stainless steel alloy. The alloy has been carefully selected and is very resistant to heat. This means that the diaphragm tension (and therefore the sensitivity) remain the same, even after several hours' operation at high temperature.

The microphone has been tested at temperatures up to 150°C. Below 150°C, no changes occur. At 150°C, the sensitivity can be permanently changed within the first hour by less than 0.05 dB. After this, the sensitivity can be permanently

changed within the next 10 hours by a similar value. These changes are due to decreasing charge of the electret.

Note: special adaptors (inserted between the microphone and preamplifier) must be made for high-temperature applications in order to protect the preamplifier from heat conduction and radiation.

3.10.3 Long-term Stability

The microphone's long-term stability is determined by the stability of the electret charge. The charge decays very slowly even in humid conditions. See Brüel & Kjær Technical Review no. 4, 1979 and the specifications given below:

- > 1000 years/dB (dry air at 20°C)
- > 2 hours/dB (dry air at 150°C)
- > 40 years/dB (air at 20°C, 90%RH)
- > 1 year/dB (air at 50°C, 90%RH)

3.11 Effect of Temperature

By careful selection of materials, optimization of the design and artificial ageing, the effect of temperature has been made to be very low.

The microphone has been designed to operate at temperatures from -30 to 150°C . See [section 3.10.2](#) for permanent changes in sensitivity at temperatures at 150°C .

The reversible changes are shown in [Fig.3.20](#) as a change in sensitivity and in [Fig.3.21](#) and [Fig.3.22](#) as changes in the frequency response normalized at 250 Hz.

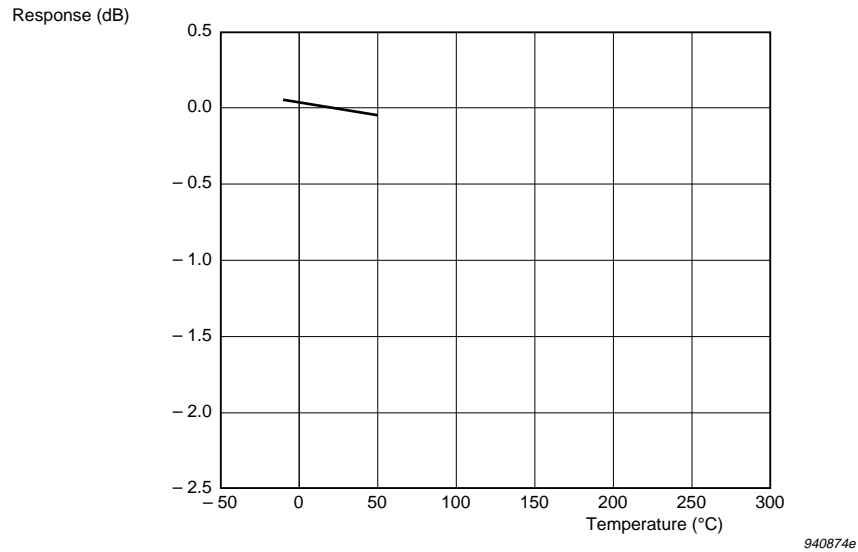

Fig. 3.20 Typical variation in sensitivity (at 250 Hz) as a function of temperature, relative to the sensitivity at 20°C

Temperature Coefficient (250 Hz):

-0.001 dB/°C, typical (for the range -10 to +50°C)

The effect of temperature on the free-field response (see [Fig.3.22](#)) of the microphone is the sum of the following effects:

- the calculated effect of the change in the speed of sound due to temperature on the 0°-incidence free-field correction
- the measured change in the actuator response due to temperature (see [Fig.3.21](#)).

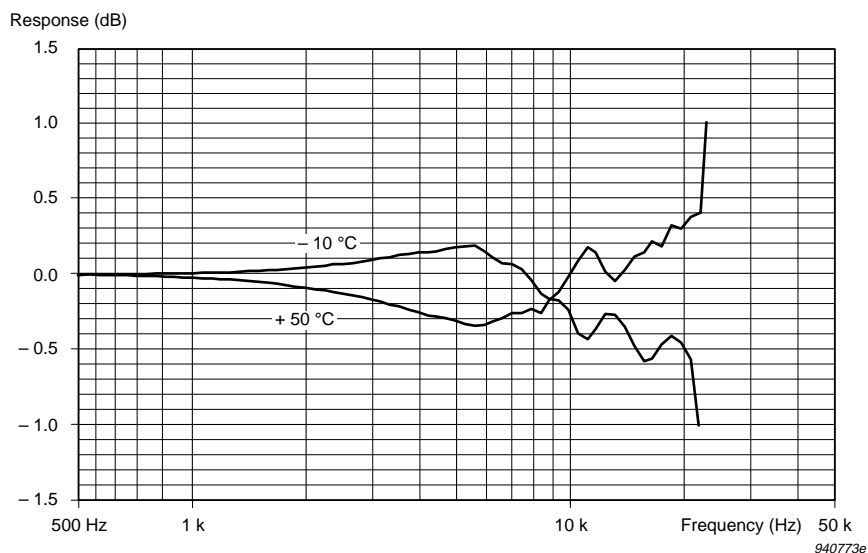

Fig.3.21 Typical variation in actuator response (normalized at 250 Hz) as a function of temperature, relative to the response at 20°C (see Fig.3.4)

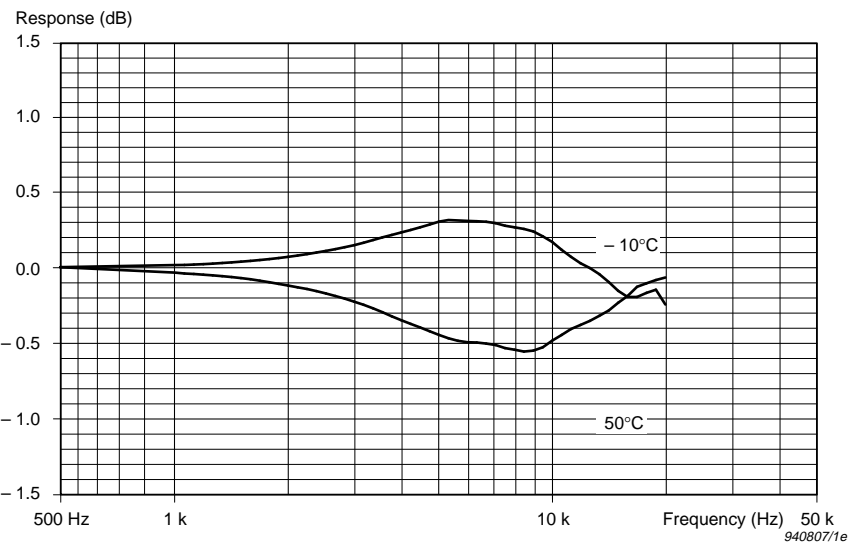

Fig.3.22 Typical variation in 0°-incidence free-field response with Protection Grid DB 3420 (normalized at 250 Hz) as a function of temperature, relative to the response at 20°C (see Fig.3.7)

3.12 Effect of Ambient Pressure

The microphone's sensitivity and frequency response are affected by variations in the ambient pressure. This is due to changes in air stiffness in the cavity behind the diaphragm, and changes in air mass in the small gap between the diaphragm and the back plate. The effects are shown in Fig.3.23 to Fig.3.25.

The typical pressure coefficient at 250 Hz for Prepolarized Free-field 1/2" Microphone Type 4189 is -0.010 dB/kPa, well within the ± 0.03 dB/kPa limits required for Type 1 sound level meters by IEC 651.

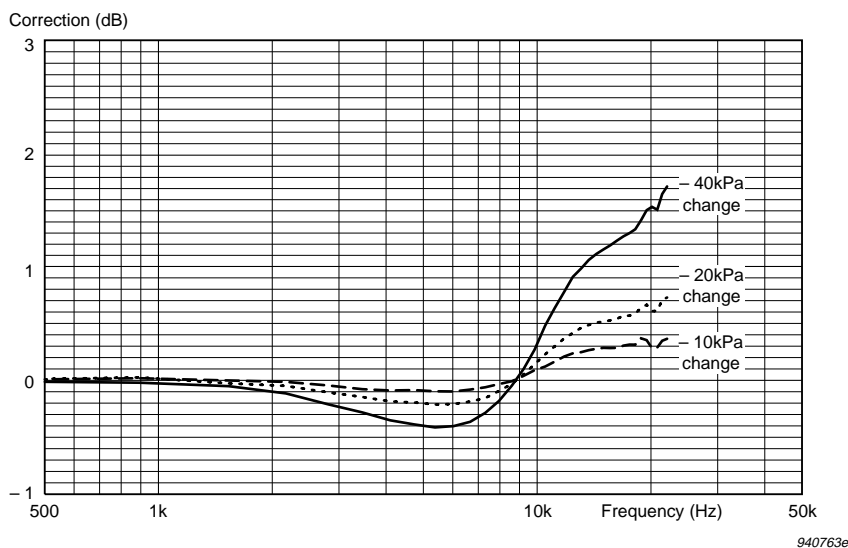
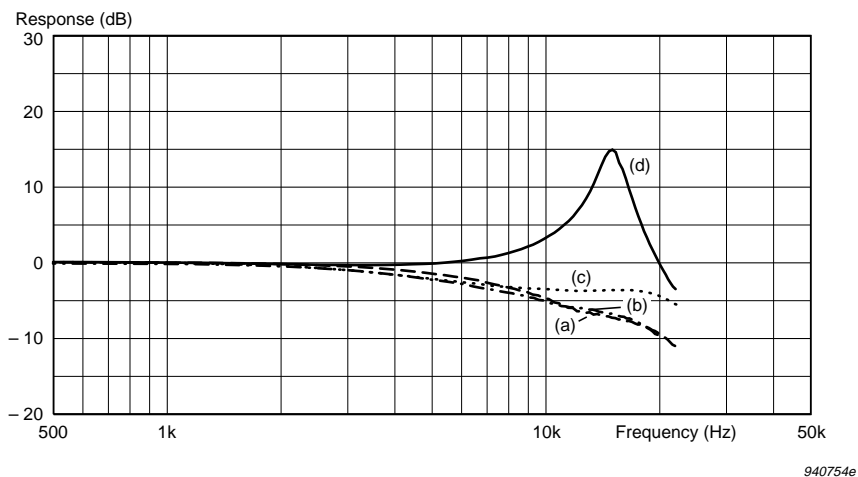

Fig.3.23 Typical variation in frequency response (normalized at 250 Hz) from that at 101.3 kPa as a function of change in ambient pressure



*Fig.3.24 Typical effect of ambient pressure on actuator response
 (a) at 101.3 kPa (b) -40 kPa change (c) -80 kPa change
 (d) at 2 kPa*

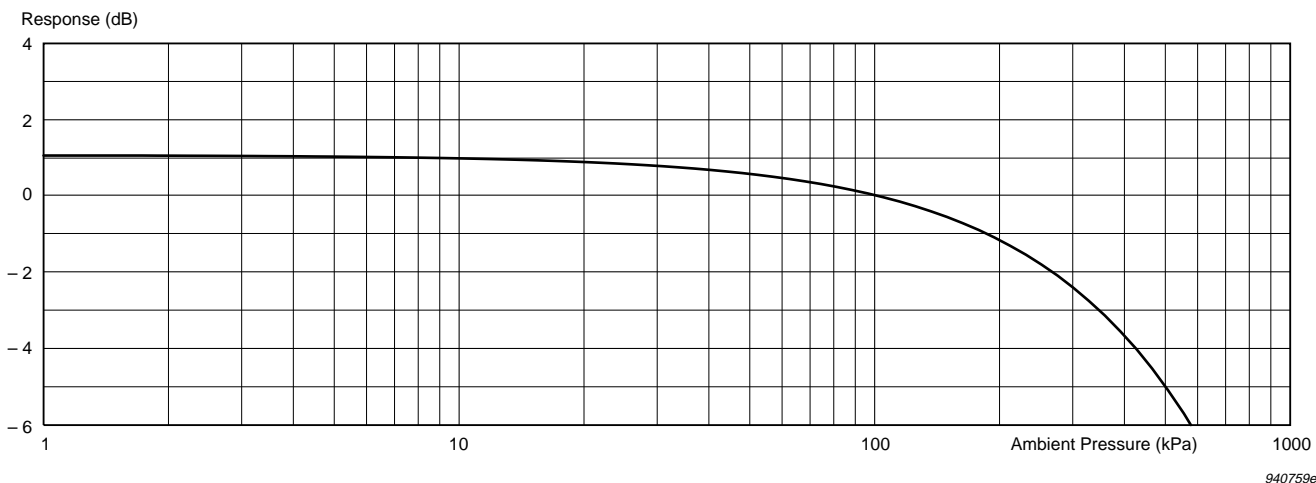

Fig.3.25 Typical variation in sensitivity at 250 Hz from that at 101.3 kPa as a function of ambient pressure

3.13 Effect of Humidity

Due to the microphone's high leakage resistance, humidity has, in general, no effect on the microphone's sensitivity or frequency response. The microphone has been tested according to IEC 68-2-3 and the effects of humidity on the sensitivity at 250 Hz and the frequency response have been found to be less than 0.1 dB at up to 95% RH (non-condensing) and 40°C.

3.14 Effect of Vibration

The effect of vibration is determined mainly by the mass of the diaphragm and is at its maximum for vibrations applied normal to the diaphragm. A vibration signal of 1 m/s^2 RMS normal to the diaphragm typically produces an equivalent Sound Pressure Level of 62.5 dB for a microphone fitted with Protection Grid DB 3420.

3.15 Effect of Magnetic Field

The effect of a magnetic field is determined by the vector field strength and is normally at its maximum when the field direction is normal to the diaphragm. A magnetic field strength of 80 A/m at 50 Hz (the test level recommended by IEC and ANSI) normal to the diaphragm produces a typical equivalent Sound Pressure Level of 6 dB. Higher frequency components in the microphone output become dominant at field strengths greater than 500 to 1000 A/m.

3.16 Electromagnetic Compatibility

See [Chapter 8](#).

3.17 Specifications Overview

<p>OPEN-CIRCUIT SENSITIVITY (250 Hz)*: -26 dB \pm1.5 dB re 1 V/Pa, 50 mV/Pa*</p> <p>POLARIZATION VOLTAGE: External: 0V</p> <p>FREQUENCY RESPONSE*: 0° incidence free-field response: 10 Hz to 8 kHz: \pm1 dB 6.3 Hz to 20 kHz: \pm2 dB In accordance with IEC 651, Type 1</p> <p>LOWER LIMITING FREQUENCY (-3 dB): 2 Hz to 4 Hz (vent exposed to sound)</p> <p>PRESSURE EQUALIZATION VENT: Rear vented</p> <p>DIAPHRAGM RESONANCE FREQUENCY: 14 kHz, typical (90° phase shift)</p> <p>CAPACITANCE (POLARIZED): 14 pF, typical (at 250 Hz)</p> <p>EQUIVALENT AIR VOLUME (101.3 kPa): 46 mm³</p> <p>_____</p> <p>* Individually calibrated</p>	<p>CALIBRATOR LOAD VOLUME (250 Hz): 260 mm³</p> <p>PISTONPHONE TYPE 4228 CORRECTION: with DP 0776: 0.00 dB</p> <p>TYPICAL CARTRIDGE THERMAL NOISE: 14.6 dB (A) 15.3 dB (Lin.)</p> <p>UPPER LIMIT OF DYNAMIC RANGE: 3% distortion: >146 dB SPL</p> <p>MAXIMUM SOUND PRESSURE LEVEL: 158 dB (peak)</p> <p>OPERATING TEMPERATURE RANGE: -30 to +150°C (-22 to 302°F)</p> <p>OPERATING HUMIDITY RANGE: 0 to 100% RH (without condensation)</p> <p>STORAGE TEMPERATURE: -30 to +70°C (-22 to 158°F)</p> <p>TEMPERATURE COEFFICIENT (250 Hz): -0.001 dB/°C, typical (for the range -10 to +50°C)</p> <p>PRESSURE COEFFICIENT (250 Hz): -0.010 dB/kPa, typical</p>	<p>INFLUENCE OF HUMIDITY: <0.1 dB/100%RH</p> <p>VIBRATION SENSITIVITY (<1000 Hz): Typically 62.5 dB equivalent SPL for 1 m/s² axial acceleration</p> <p>MAGNETIC FIELD SENSITIVITY: Typically 6 dB SPL for 80 A/m, 50 Hz field</p> <p>ESTIMATED LONG-TERM STABILITY: > 1000 years/dB (dry air at 20°C) > 2 hours/dB (dry air at 150°C) > 40 years/dB (air at 20°C, 90% RH) > 1 year/dB (air at 50°C, 90% RH)</p> <p>DIMENSIONS: Diameter: 13.2 mm (0.52 in) (with grid) 12.7 mm (0.50 in) (without grid) Height: 17.6 mm (0.68 in) (with grid) 16.3 mm (0.64 in) (without grid) Thread for preamplifier mounting: 11.7 mm – 60 UNS</p> <p>The data above are valid at 23°C, 101.3 kPa and 50%RH, unless otherwise specified.</p>
---	---	---

3.18 Ordering Information

Preamplifier

Type 2669: 1/2" Microphone Preamplifier

Type 2671: 1/2" Microphone Preamplifier

Calibration Equipment

Type 4231: Sound Level Calibrator

Type 4226: Multifunction Acoustic Calibrator

Type 4228: Pistonphone

UA 0033: Electrostatic Actuator

Other Accessories

UA 0308: Dehumidifier

UA 0254: Set of 6 Windscreens (UA 0237) 90 mm (3.5 in)

UA 0469: Set of 6 Windscreens (UA 0459) 65 mm (2.6 in)

Chapter 4

Free-field 1/2" Microphone Type 4190

4.1 Introduction

4.1.1 Description



Fig. 4.1 Free-field $\frac{1}{2}$ " Microphone Type 4190 with Protection Grid DB 3420 (included)

Free-field $\frac{1}{2}$ " Microphone Type 4190 is an externally-polarized microphone for general sound measurements and for standardized noise measurements in accordance with the requirements of IEC 651 Type 0 and Type 1. With its low inherent noise and frequency range from 3.15 Hz to 20 kHz, it is very well suited for a wide range of precision audio-frequency sound measurements.

The microphone requires a polarization voltage of 200 V, provided by the instrument or analyzer powering the associated preamplifier.

This rugged microphone is built to ensure high stability under a variety of conditions. For example, the stainless steel alloy diaphragm withstands polluted industrial environments. The diaphragm clamping ring is firmly secured to ensure the microphone's reliability, even when the microphone is used without its protection grid. When the microphone is used without its protection grid, it can be easily flush-mounted or inserted into closed volumes as it can be supported by the diaphragm clamping ring, provided that a force of less than 5 Newtons is applied.

The microphone is supplied with individual calibration data on a calibration chart and on a $3\frac{1}{2}$ " data disk in a case. This case can also contain a $\frac{1}{2}$ " Microphone Preamplifier Type 2669.

4.1.2 The Calibration Chart

Each microphone is supplied with an individual calibration chart (see Fig. 4.2) which gives the microphone's open-circuit sensitivity, polarized capacitance and free-field and actuator frequency responses.

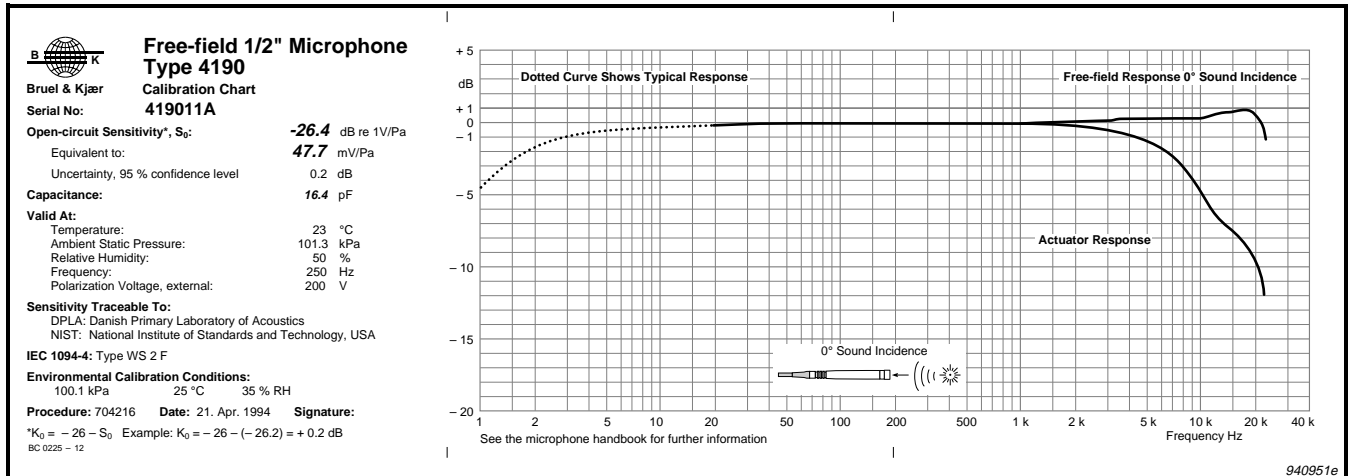

Fig. 4.2 Microphone calibration chart

Open-circuit Sensitivity

The stated open-circuit sensitivity is valid at the reference frequency (251.2 Hz^*) for free-field, random-incidence and pressure-field conditions. The stated uncertainty is the U_{95} value (the value valid for 95% confidence level).

Ambient Conditions

The ambient conditions are measured continuously during calibration at the factory. The calibration results obtained at the measured Environmental Calibration Conditions are corrected to the reference ambient conditions stated under Valid At (23°C , 101.325 kPa and $50\% \text{ RH}$).

Frequency Responses

Two individual frequency responses are shown on the calibration chart. Both are normalized to 0 dB at the reference frequency (251.2 Hz^*).

The upper curve on the calibration chart is the individual microphone's open-circuit 0° -incidence free-field response. This response is the optimized response for Free-field $\frac{1}{2}$ " Microphone Type 4190.

*The exact reference frequency is $10^{2.4} \text{ Hz}$ (re ISO 266).

The lower curve on the calibration chart is the individual microphone's electrostatic actuator response measured with Electrostatic Actuator UA 0033. This response is used to determine free-field responses at angles of incidence other than 0° and responses in other types of sound field. The individual microphone's electrostatic actuator response is also available on the data disk.

The dotted part of the curve is the typical low-frequency response. Each microphone's individual lower limiting frequency is measured to ensure that it is within the specified tolerances (see [Fig.4.3](#)).

4.1.3 Data Disk

The 3 1/2" data disk supplied with each microphone supplements the calibration chart. It contains individual calibration data and correction curves (see [Table 4.1](#)) with a frequency resolution of 1/12-octave as comma-separated ASCII text files under the \DATA directory.

File Name	Content	Frequency Range
S#####.BKM ^a	Sensitivity calibration	251.2 Hz
A#####.BKM ^a	Actuator response	200 Hz – 22 kHz
F#####.BKR ^b	Free-field response	1 Hz – 22 kHz
4190L.BKT ^c	Low-frequency response	1 Hz – 190 Hz
4190F.BKC ^d	Free-field corrections without protection grid	200 Hz – 22 kHz
4190FG.BKC ^d	Free-field corrections with protection grid	200 Hz – 22 kHz
4190R.BKC ^d	Random-incidence corrections without protection grid	200 Hz – 22 kHz
4190RG.BKC ^d	Random-incidence corrections with protection grid	200 Hz – 22 kHz
4190P.BKC ^d	Pressure-field corrections	200 Hz – 22 kHz

Table 4.1 Calibration data and corrections contained on the data disk. Note: ##### is the microphone's serial number

a. Individual calibration data (measured).

b. Low-frequency response combined with actuator response and free-field corrections.

c. Typical response for Free-field 1/2" Microphone Type 4190.

d. Corrections for Free-field 1/2" Microphone Type 4190.

These text files can be viewed on Microsoft® Windows™ using the Brüel & Kjær Microphone Viewer program (BK-MIC.EXE) supplied on the disk. They can also be accessed by a suitable spreadsheet for further processing or printing.

Brüel & Kjær Microphone Viewer must be installed before use (see [section 1.3.5](#)).

4.1.4 Recommended Recalibration Interval

With normal handling of the microphone and any associated instrument, Brüel & Kjær recommends that the microphone be recalibrated every 2 years.

Free-field 1/2" Microphone Type 4190 is very stable over this period (see [section 4.10](#) to [section 4.12](#)). Improper handling is by far the most likely cause of change in the microphone's properties. Any damage which causes improper operation can probably be detected using a sound level calibrator. In many cases, the damage can be seen by carefully inspecting the protection grid and diaphragm.

4.2 Sensitivity

4.2.1 Open-circuit Sensitivity

The open-circuit sensitivity is defined as the sensitivity of the microphone when not loaded by the input impedance of the connected preamplifier (the termination is described in IEC 1094–2). The sensitivity is measured for the individual microphone at 251.2 Hz and stated on the microphone's calibration chart (see [section 4.1.2](#)) and data disk (see [section 4.1.3](#)). The nominal sensitivity is shown in [Table 4.1](#).

Nominal open-circuit sensitivity		Accepted Deviation (dB)
mV/Pa	dB re 1 V/Pa	
50	–26.0	± 1.5

Table 4.2 Nominal open-circuit sensitivity

4.2.2 Loaded Sensitivity

When loaded by a preamplifier, the sensitivity of the microphone is given by:

$$S_C = S_O + G \quad (4.1)$$

where

- S_C = overall sensitivity of microphone and preamplifier combination
- S_O = open-circuit sensitivity of microphone
- G = voltage gain of microphone and preamplifier combination (in dB)

With Microphone Preamplifier Type 2639: $G = -0.1$ dB

With 1/2" Microphone Preamplifier Type 2669: $G = -0.2$ dB

Example

Loaded sensitivity of typical microphone with 1/2" Microphone Preamplifier Type 2669:

$$S_C = -26.3 + (-0.2) = -26.5 \text{ dB}$$

4.2.3 K-factor

Some types of Brüel & Kjær instruments use the K-factor (correction factor) or the K_O -factor (open-circuit correction factor) for calibration.

$$K = -26 - S_C \quad (4.2)$$

$$K_O = -26 - S_O \quad (4.3)$$

Example

Correction factor for typical microphone with 1/2" Microphone Preamplifier Type 2669:

$$K = -26 - (-26.5) = +0.5 \text{ dB}$$

Open-circuit correction factor for typical microphone with 1/2" Microphone Preamplifier Type 2669:

$$K_O = -26 - (-26.3) = +0.3 \text{ dB}$$

4.3 Frequency Response

4.3.1 General

In acoustic measurements, there are three types of sound field:

- Free field
- Pressure field
- Diffuse field

The microphone is optimized to have a flat frequency response in one of these sound fields. This response is called the optimized response. A microphone's response in a diffuse field is equivalent to its random-incidence response.

This section shows the microphone's typical free-field, pressure-field and random-incidence responses together with the microphone's typical actuator response obtained using Electrostatic Actuator UA 0033. The low-frequency response described in [section 4.3.4](#) is common for all types of response.

All frequency responses and correction curves are shown with a frequency resolution of $\frac{1}{12}$ -octave.

4.3.2 Optimized Response (0° -incidence Free-field Response)

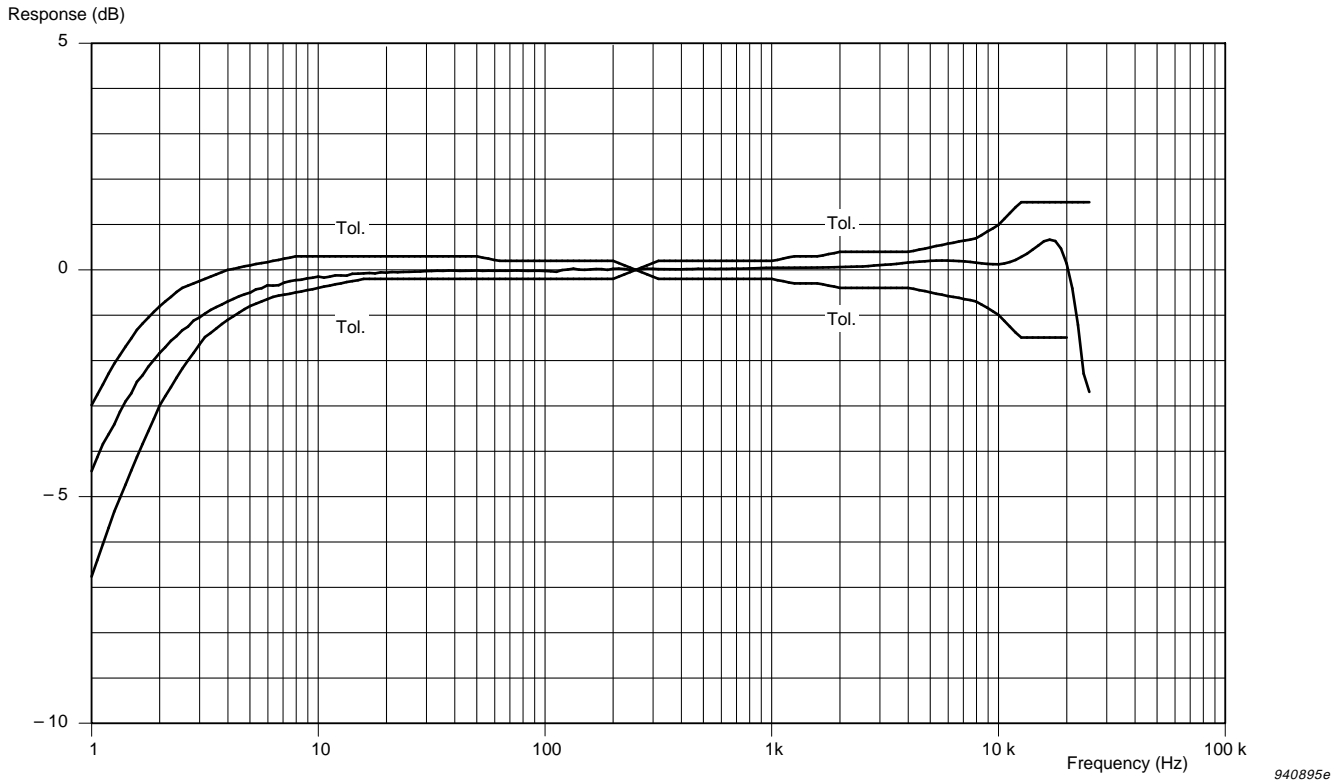

Fig. 4.3 Typical free-field response of the microphone with Protection Grid DB 3420 and the microphone's specified tolerances. The low-frequency response is valid when the vent is exposed to the sound field

The frequency response of Free-field $\frac{1}{2}$ " Microphone Type 4190 meets the requirements of IEC 651 Type 0 and Type 1.

4.3.3 Actuator Response

The microphone's frequency response is determined by adding corrections for the type of sound field to its actuator response obtained using Electrostatic Actuator UA 0033. This is a reproducible and practical method for calibrating a microphone's frequency response.

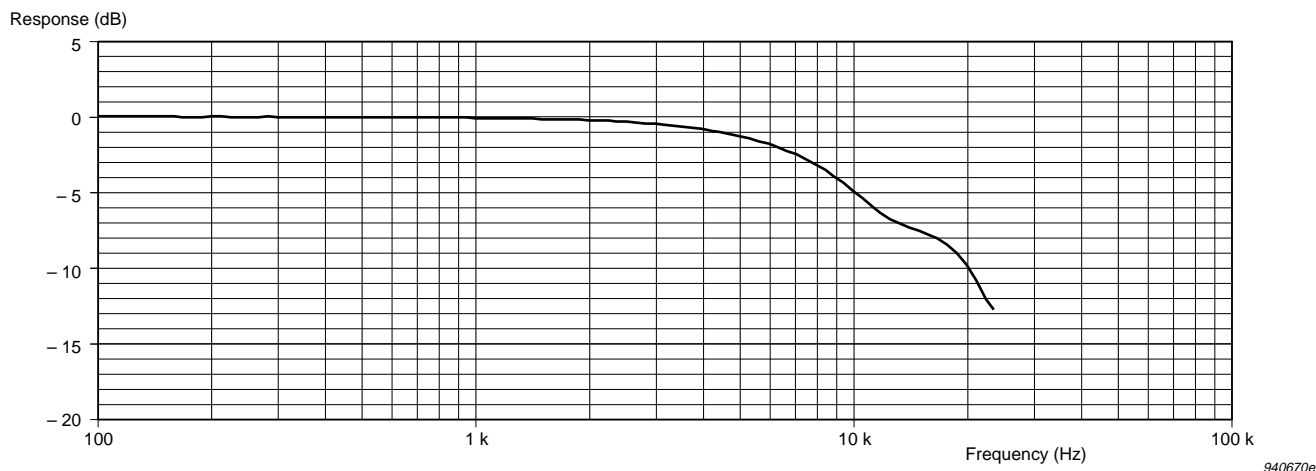

Fig 4.4 Typical actuator response (magnitude) measured with Electrostatic Actuator UA 0033

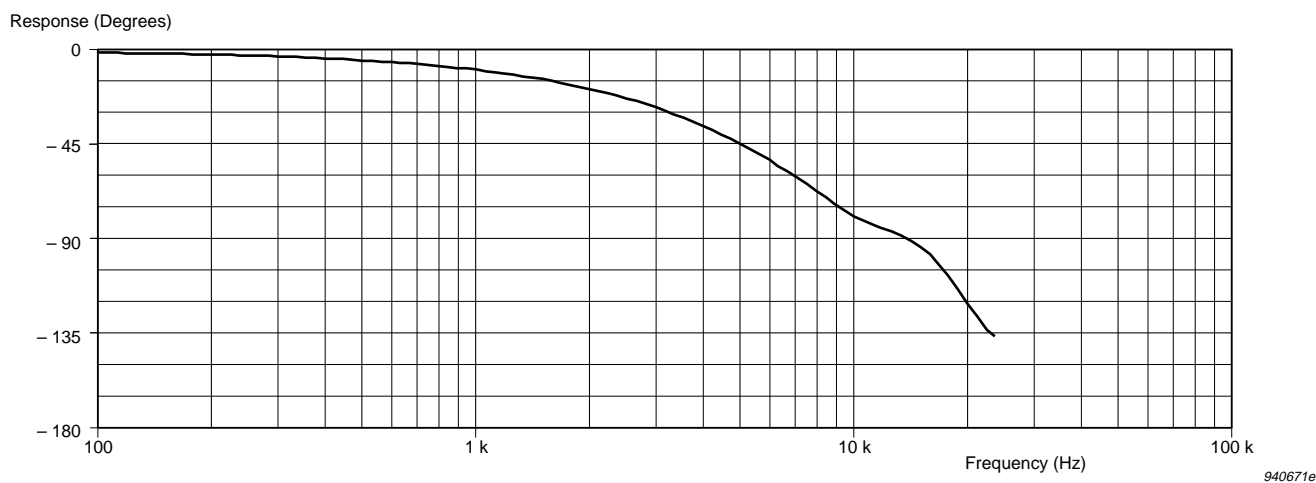

Fig 4.5 Typical actuator response (phase) measured with Electrostatic Actuator UA 0033

If the polarization voltage is positive (as it is with Brüel & Kjær instruments), the output voltage is negative for a positive pressure applied to the diaphragm.

4.3.4 Low-frequency Response

The low-frequency response (see Fig 4.3) is the typical response with the vent exposed to the sound field. If the vent is not exposed to the sound field, the sensitivity increases from 0 dB at the reference frequency (251.2 Hz) to approximately 0.3 dB at 1 Hz.

For applications where the vent is not exposed to the sound field, take care to ensure proper static pressure equalization to prevent static displacement of the diaphragm.

The microphone's low-frequency response is common for all types of sound field.

The microphone's lower limiting frequency (-3 dB) is between 1 and 2 Hz with the vent exposed to the sound field. This is measured during production to ensure that specifications are fulfilled.

4.3.5 Free-field Response

The microphone's free-field correction curves are shown in Fig.4.6 and Fig.4.8. These corrections are added to the microphone's actuator response obtained using Electrostatic Actuator UA 0033 in order to determine the free-field response at any angle of incidence. The typical free-field response at 0° incidence with and without the protection grid are shown in Fig.4.7 and Fig.4.9.

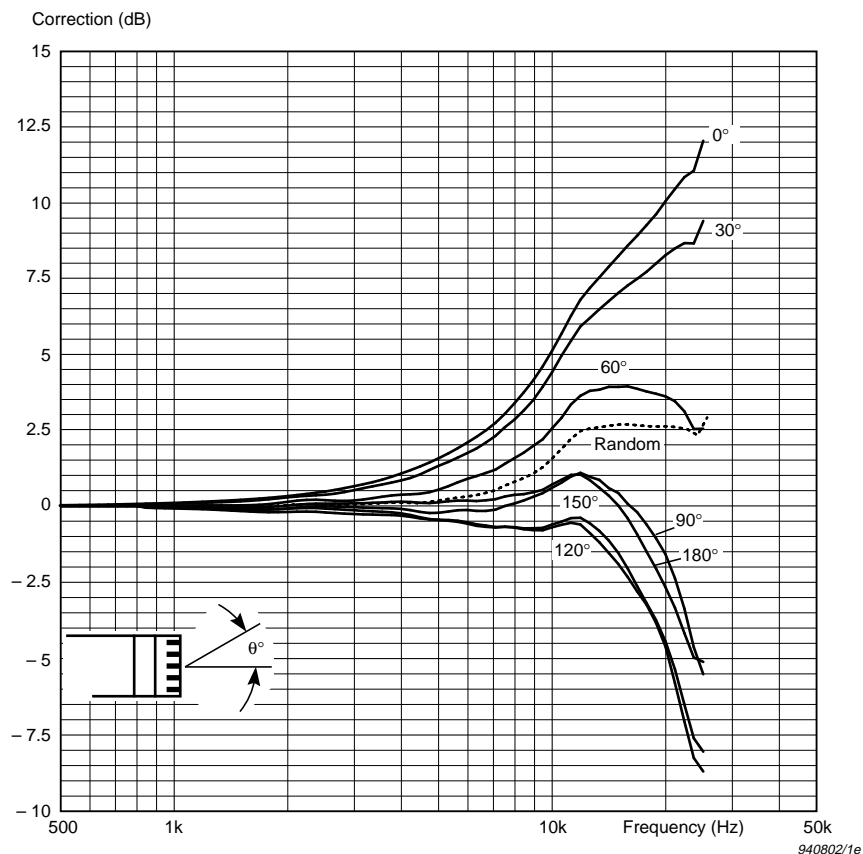

Fig. 4.6 Free-field correction curves for the microphone with Protection Grid DB 3420

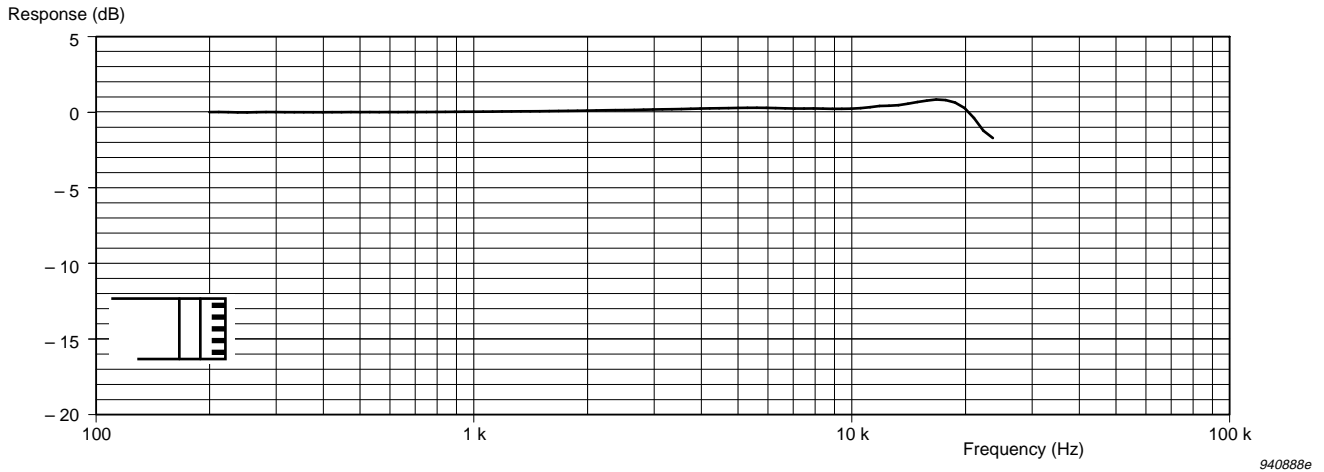

Fig 4.7 Typical free-field response (0° incidence) for the microphone with Protection Grid DB 3420

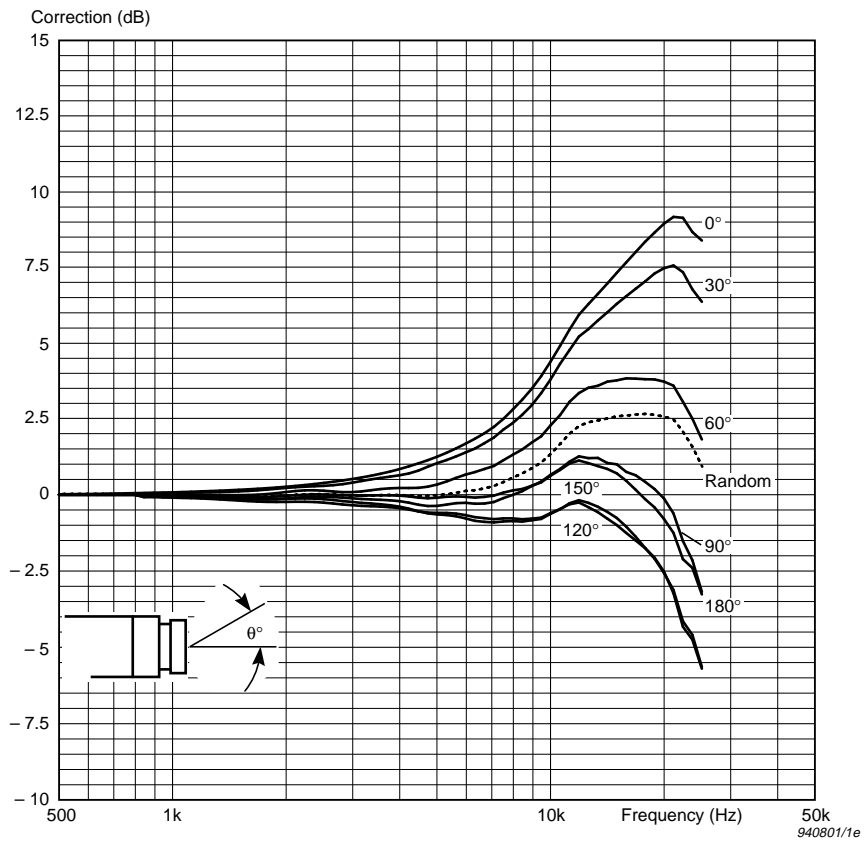

Fig 4.8 Free-field correction curves for the microphone without protection grid

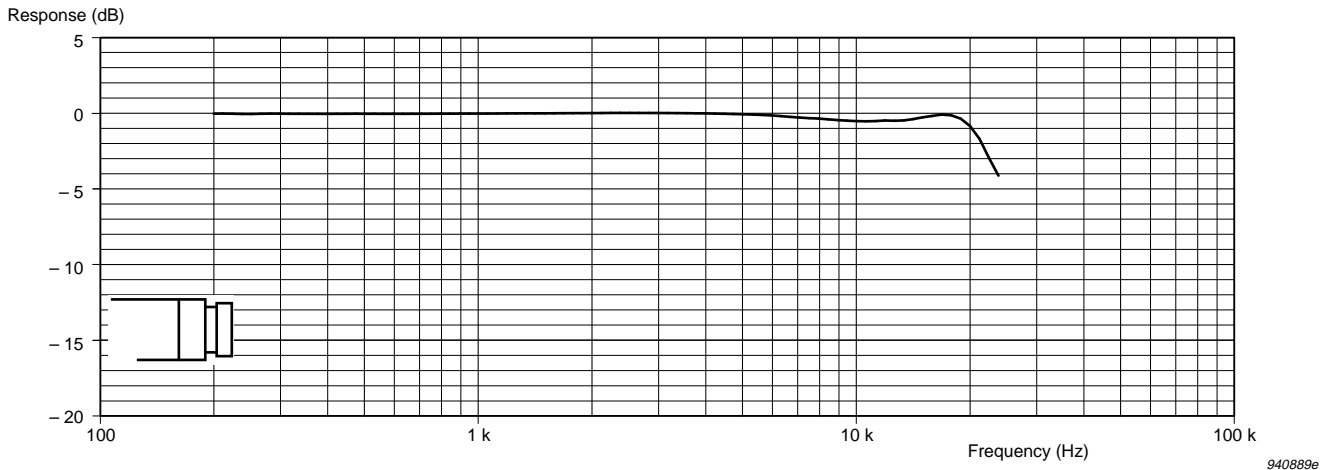

Fig 4.9 Typical free-field response (0° incidence) for the microphone without protection grid

4.3.6 Random-incidence Response

A microphone's response in a diffuse sound field is equivalent to its random-incidence response. The microphone's random-incidence correction curves are shown in Fig.4.6 and Fig.4.8. These corrections are added to the microphone's actuator response obtained using Electrostatic Actuator UA 0033 in order to determine the random-incidence response. The typical random-incidence response with and without the protection grid are shown in Fig.4.10 and Fig.4.11.

The random-incidence corrections are calculated from the free-field corrections measured in 5° steps according to Draft IEC 1183–1993.

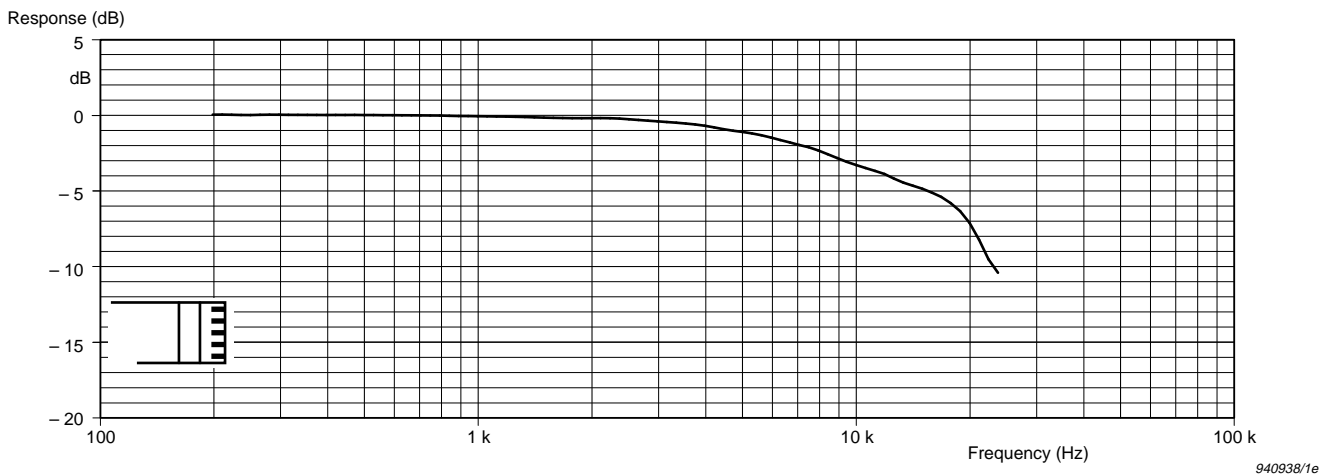

Fig 4.10 Typical random-incidence response for the microphone with Protection Grid DB 3420

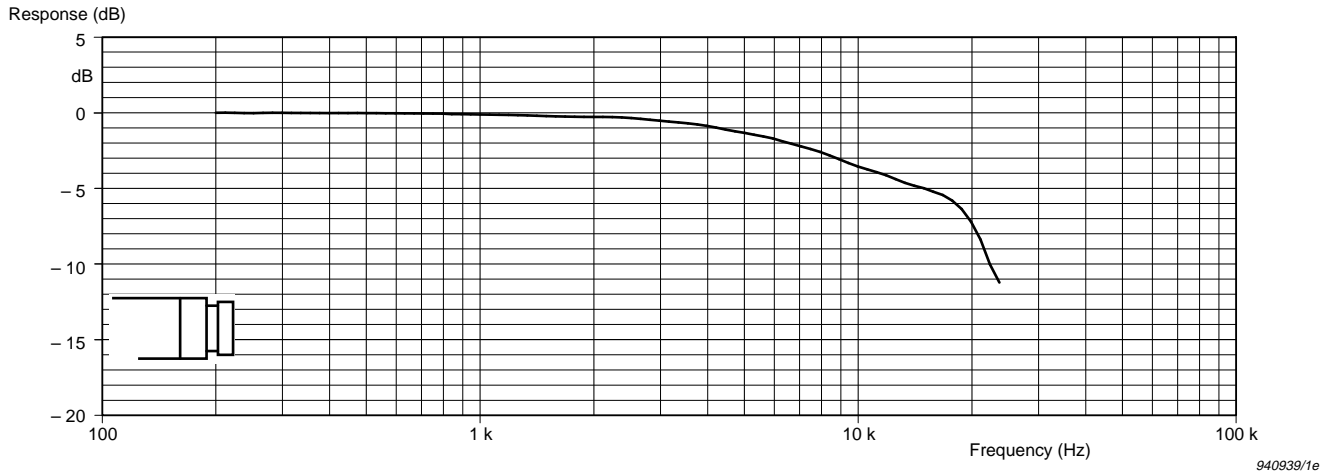

Fig. 4.11 Typical random-incidence response for the microphone without protection grid

4.3.7 Pressure-field Response

The microphone's pressure-field correction curve is shown in Fig. 4.12. This correction is added to the microphone's actuator response obtained using Electrostatic Actuator UA 0033 in order to determine the pressure-field response. The typical pressure-field response is shown in Fig. 4.13.

In practice, the pressure-field response is often regarded as being equal to the actuator response as the difference between them is small compared to the uncertainty related to many types of measurement.

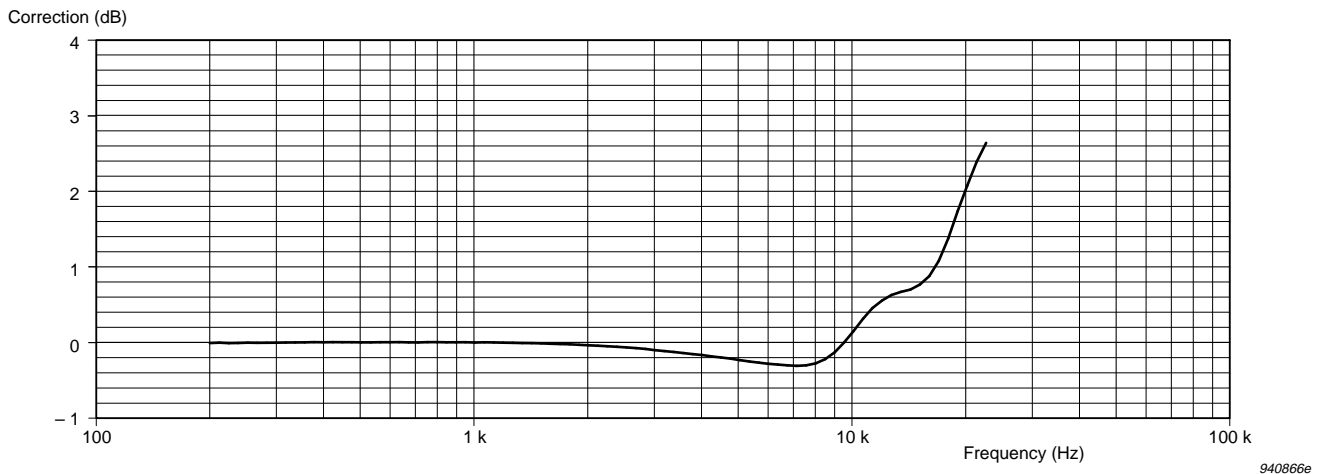

Fig. 4.12 Pressure-field correction for the microphone

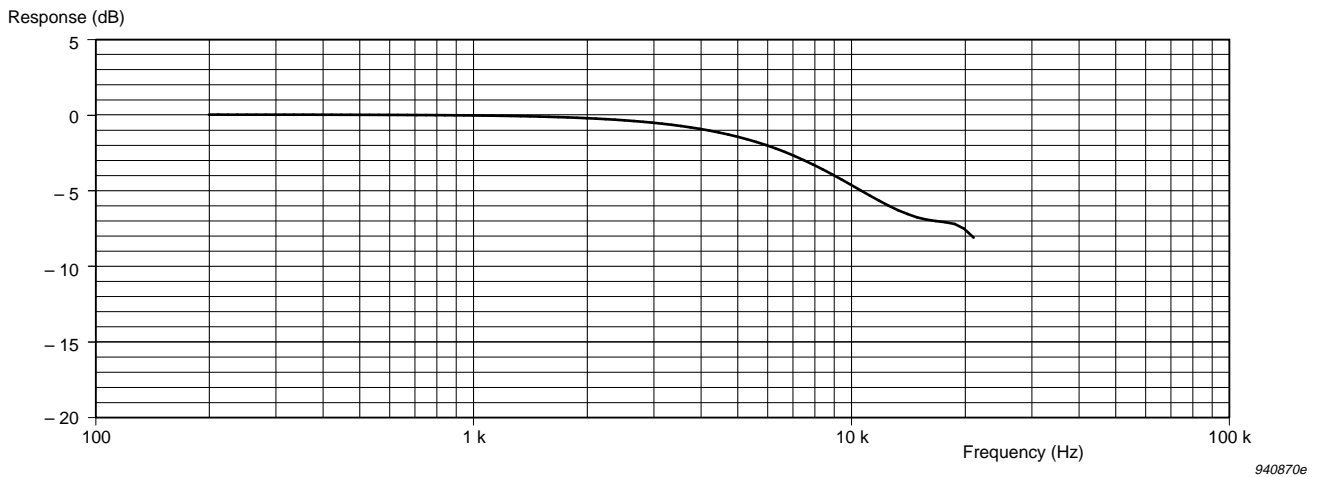

Fig. 4.13 Typical pressure-field response for the microphone

4.4 Directional Characteristics

Typical directional characteristics are given in [Fig. 4.14](#) and [Fig. 4.15](#). The characteristics are normalised relative to the 0° response.

Note: The non-symmetrical responses are at frequencies outside the microphone's nominal operating range (25 and 31.5 kHz).

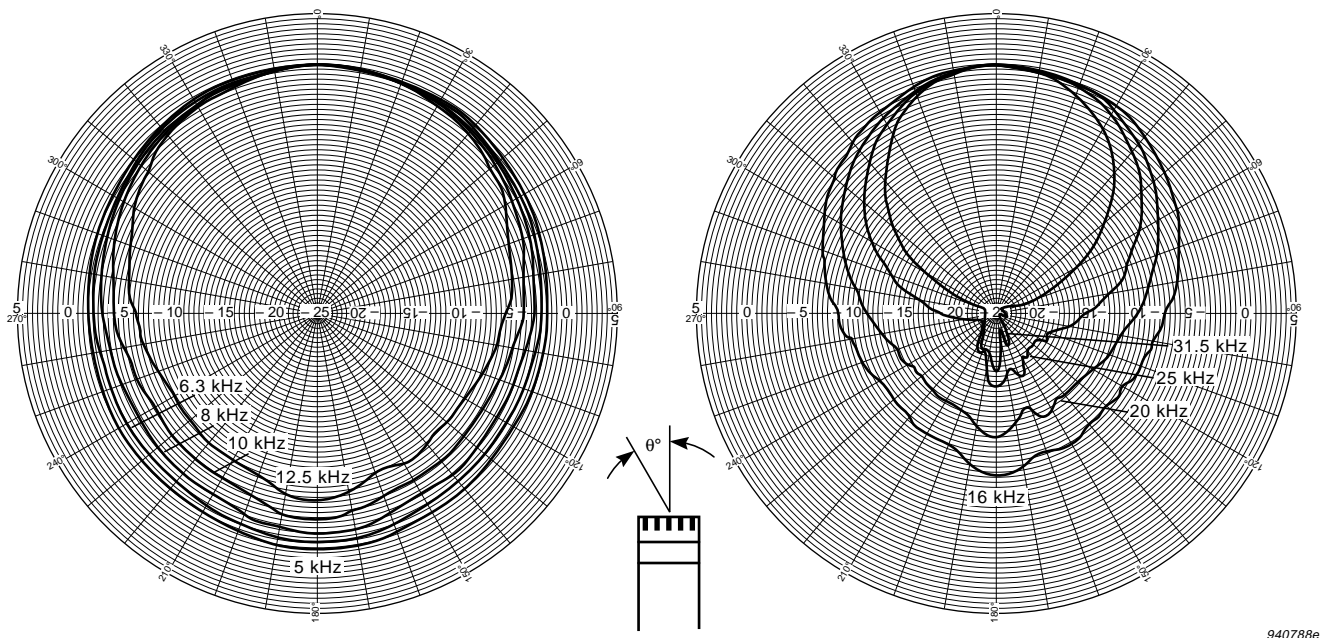
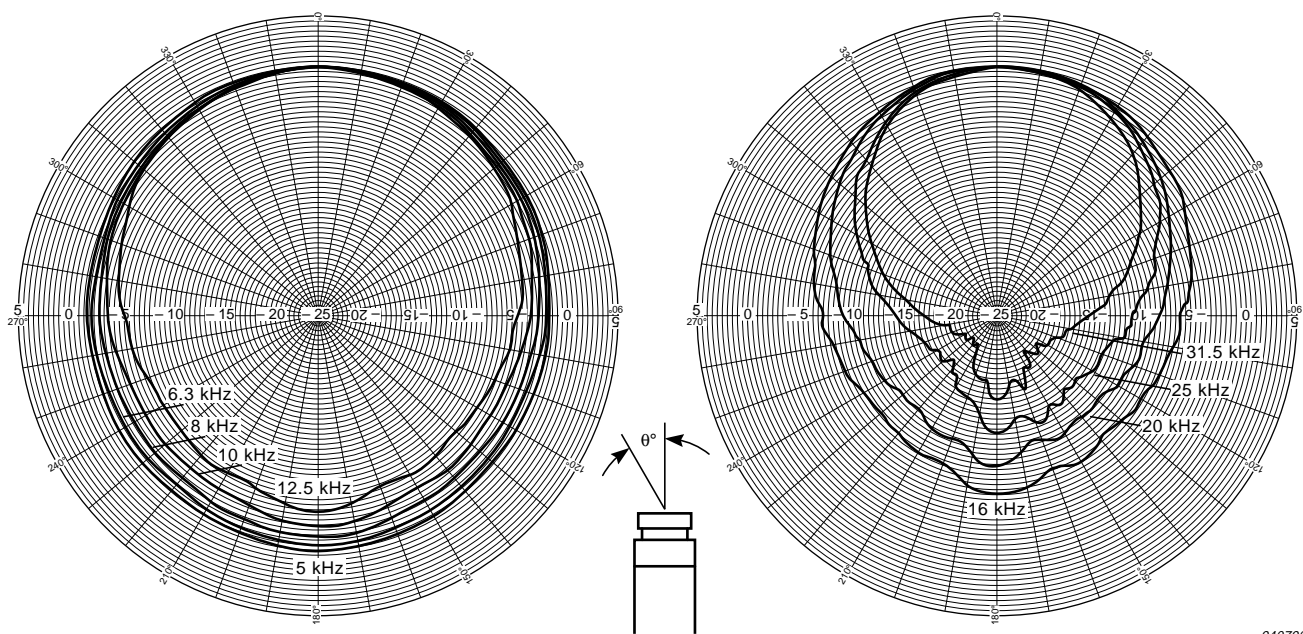

Fig. 4.14 Typical directional characteristics of the microphone with Protection Grid DB 3420



940790e

Fig. 4.15 Typical directional characteristics of the microphone without protection grid

4.5 Dynamic Range

Definition

The dynamic range is the range between the upper limit (determined by distortion) and the inherent noise floor. Both limits are influenced by the preamplifier. This section gives values for the microphone with and without a preamplifier.

Inherent Noise

The microphone's inherent noise is due to thermal movements of the diaphragm. These vary proportionally with the square root of the absolute temperature (in °K). The inherent noise increases with increasing temperature. With reference to 20 °C, the inherent noise changes by +0.5 dB at 55 °C and by -0.5 dB at -12 °C. The maximum variation of this noise for different samples of Free-field 1/2" Microphone Type 4190 is ± 1 dB.

The preamplifier's effect on the inherent noise of the combined microphone and preamplifier depends on the sensitivity and capacitance of the microphone (for 1/2" Microphone Preamplifier Type 2669, see Fig. 4.16 and [Chapter 8](#)).

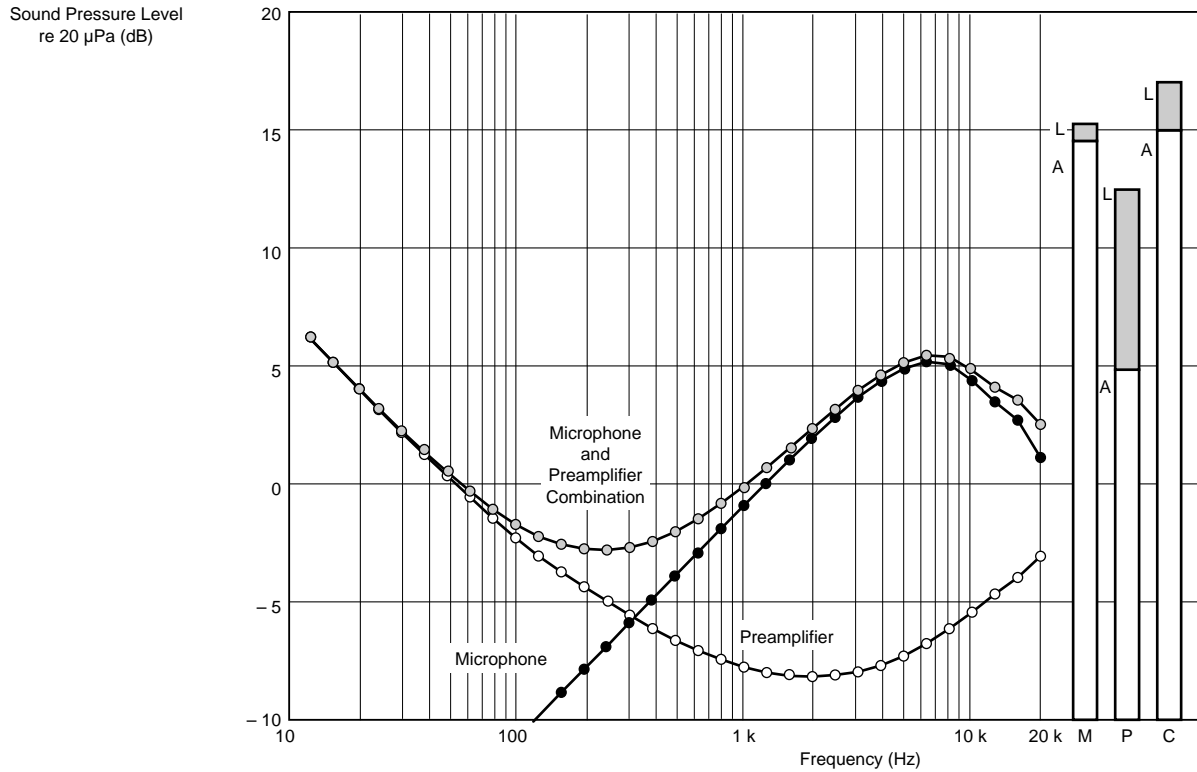

940718e

Fig. 4.16 1/3-octave-band inherent noise spectra. The shaded bar graphs are the broad-band (20 Hz to 20 kHz) noise levels and the white bar graphs the A-weighted noise levels of the microphone (M), 1/2" Microphone Preamplifier Type 2669 (P) and microphone and preamplifier combination (C)

Distortion

The distortion is determined mainly by the microphone but, at the highest operation levels, the preamplifier also contributes to the distortion (see Fig. 4.17).

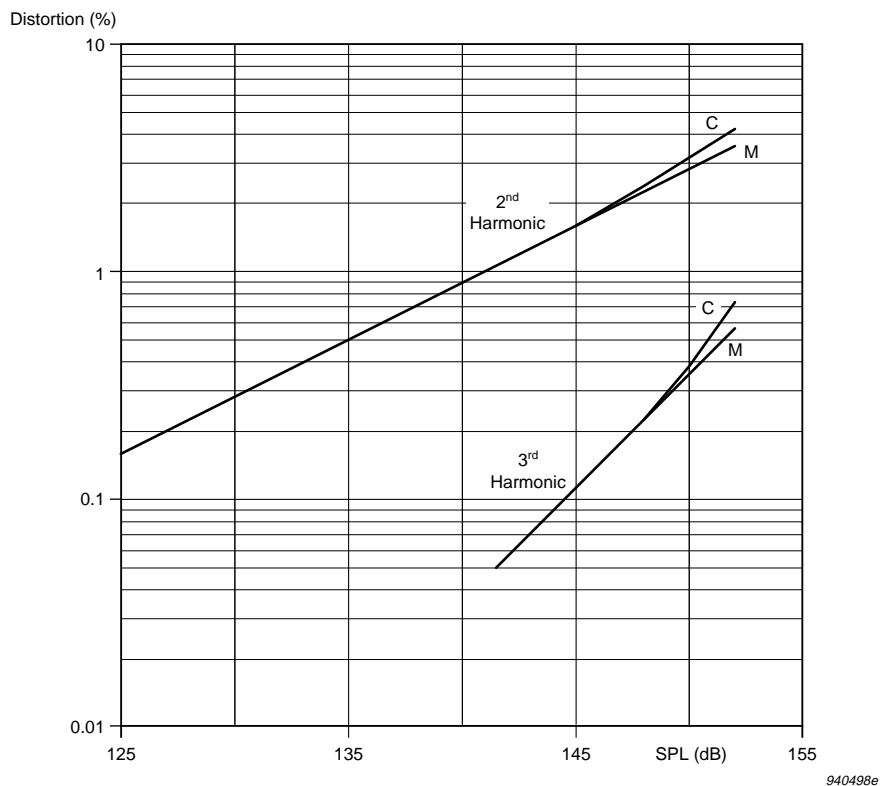

Fig. 4.17 Typical distortion characteristics of the microphone with 1/2" Microphone Preamplifier Type 2669 (C) and unloaded (M)

The distortion is dependent on the capacitance parallel to the microphone. It increases with increasing capacitance. The distortions given in [Table 4.3](#) and [Table 4.4](#) are valid for a parallel capacitance of 0.5 pF. The distortion is measured at 100 Hz but can be assumed to be valid up to approximately 5 kHz (that is, where the diaphragm displacement is predominantly stiffness-controlled). Distortion measurement methods for higher frequencies are not available.

Maximum Sound Pressure Level

In general, the microphone should not be exposed to sound pressure levels which produce voltages higher than the maximum input voltage specified for the connected preamplifier. After an overload, the preamplifier needs time to recover and, during this recovery period, you cannot measure validly. The maximum input voltage for most Brüel & Kjær preamplifiers is ± 50 V (with a 130 V supply). This voltage is

Lower Limit				Upper Limit	
1 Hz bandwidth at 1 kHz (dB)	1/3-octave band at 1 kHz (dB)	A-weighted (dB)	Linear 20 Hz to 20 kHz (dB)	< 3% distortion (dB)	Max. SPL (Peak) (dB)
-24.3	-0.7	14.6	15.3	148	159

Table 4.3 Dynamic range of the microphone

Lower Limit				Upper Limit	
1 Hz bandwidth at 1 kHz (dB)	1/3-octave band at 1 kHz (dB)	A-weighted (dB)	Linear 20 Hz to 20 kHz (dB)	< 3% distortion (dB)	Max. SPL (Peak) (dB)
-23.6	0.0	15.0	17.0	147	154

Table 4.4 Dynamic range of the microphone with 1/2" Microphone Preamplifier Type 2669

produced by a nominal Free-field 1/2" Microphone Type 4190 at a Peak level of 154 dB (re 20 µPa).

The microphone will maintain its charge up to a Peak level of 159 dB (re 20 µPa). Above this level, the diaphragm and back plate short-circuit. If this occurs, the microphone needs one or two minutes to recharge before it is ready to measure validly. We recommend not to expose Free-field 1/2" Microphone Type 4190 to levels higher than 159 dB (Peak).

4.6 Equivalent Volume and Calibrator Load Volume

Equivalent Volume

For some applications it is practical to express the acoustic impedance of the microphone diaphragm in terms of a complex equivalent volume. This makes it easier to evaluate the effect of microphone loading on closed cavities or acoustic calibration couplers.

The real and imaginary parts of the equivalent volume shown in [Fig.4.18](#) are in parallel. They are calculated from a simple R-L-C series model of the microphone which gives the best overall approximation of the microphone's diaphragm impedance.

The Models

The following equivalent models are valid at 101.325 kPa, 23 °C and 50%RH:

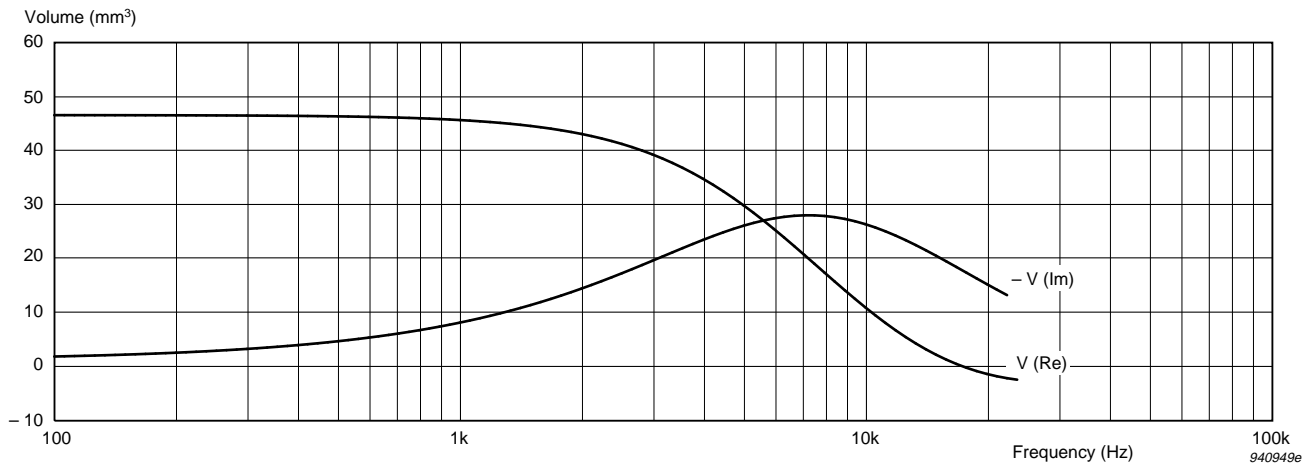

Fig 4.18 Typical equivalent volume (real and imaginary parts) based on mathematical model of microphone

Model 1

$$C = 0.324 \times 10^{-12} \text{ m}^5/\text{N}$$

$$L = 305 \text{ kg/m}^4$$

$$R = 77 \times 10^6 \text{ Ns/m}^5$$

where C = acoustic diaphragm compliance
 L = acoustic diaphragm mass
 R = acoustic diaphragm damping resistance

Model 2

$$V_{lf} = 46 \text{ mm}^3$$

$$f_0 = 16 \text{ kHz}$$

$$Q = 0.4$$

where V_{lf} = low-frequency volume
 f_0 = diaphragm resonance frequency
 Q = quality factor

Calibrator Load Volume

When the microphone with its protection grid is inserted into the coupler of a calibrator, it will load the calibrator by a volume of 250 mm³ at 250 Hz.

Load volume correction to Pistonphone Type 4228 Calibration Level (with Adaptor DP 0776): 0.00 dB

4.7 Capacitance

The microphone's impedance is determined by its polarized capacitance. In addition, the preamplifier's input resistance and capacitance load the microphone. This loading determines the electrical lower limiting frequency and the capacitive input attenuation. However, with modern preamplifiers, this loading is very small and is included in the preamplifier gain, G (see [section 4.2.2](#)). Only in special cases with high capacitive loading does the fall in capacitance with frequency have to be taken into account.

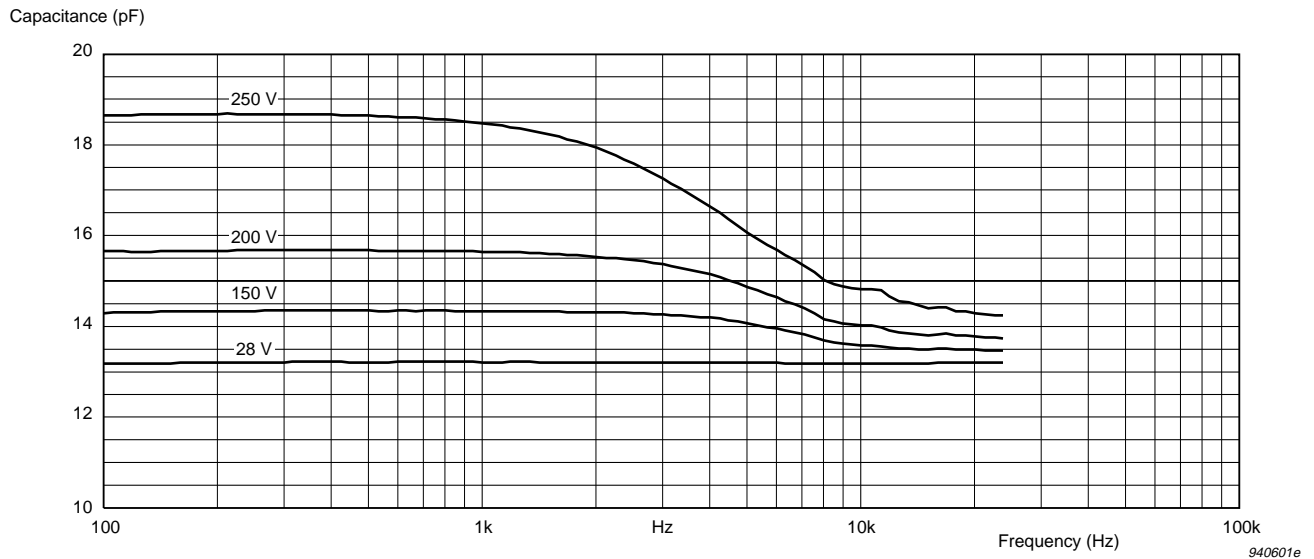

Fig. 4.19 Variation of capacitance with polarization voltage and frequency

Typical capacitance (at 250 Hz): 16 pF.

The capacitance is individually calibrated and stated on the calibration chart.

4.8 Polarization Voltage

Generally, a microphone is operated at its nominal polarization voltage. For Free-field $\frac{1}{2}$ " Microphone Type 4190, this is 200 V. As this polarization voltage is positive, the output voltage is negative for a positive pressure applied to the diaphragm.

In special cases where there is a risk of preamplifier overload or there are long cables to be driven, choose a lower voltage. This will cause a lower sensitivity (see [Fig. 4.20](#)) and a change in the frequency response (see [Fig. 4.21](#)).

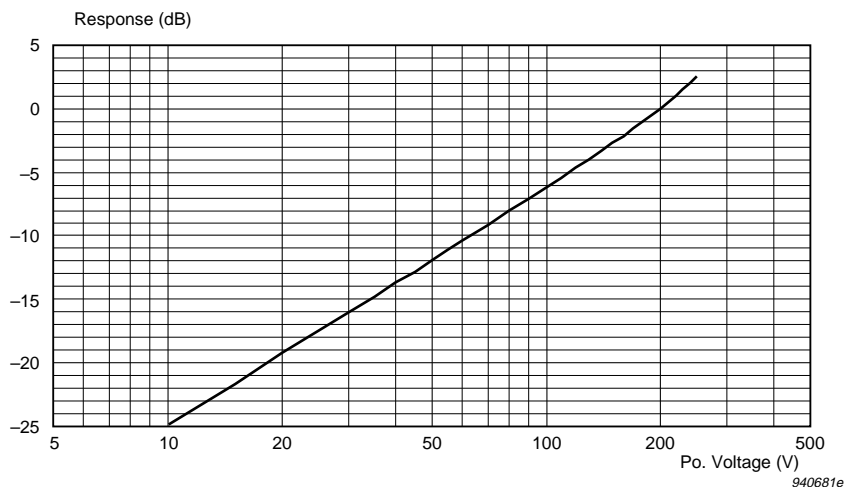

Fig.4.20 Variation in sensitivity (at 250Hz) as a function of polarization voltage, relative to the sensitivity with a polarization voltage of 200 V

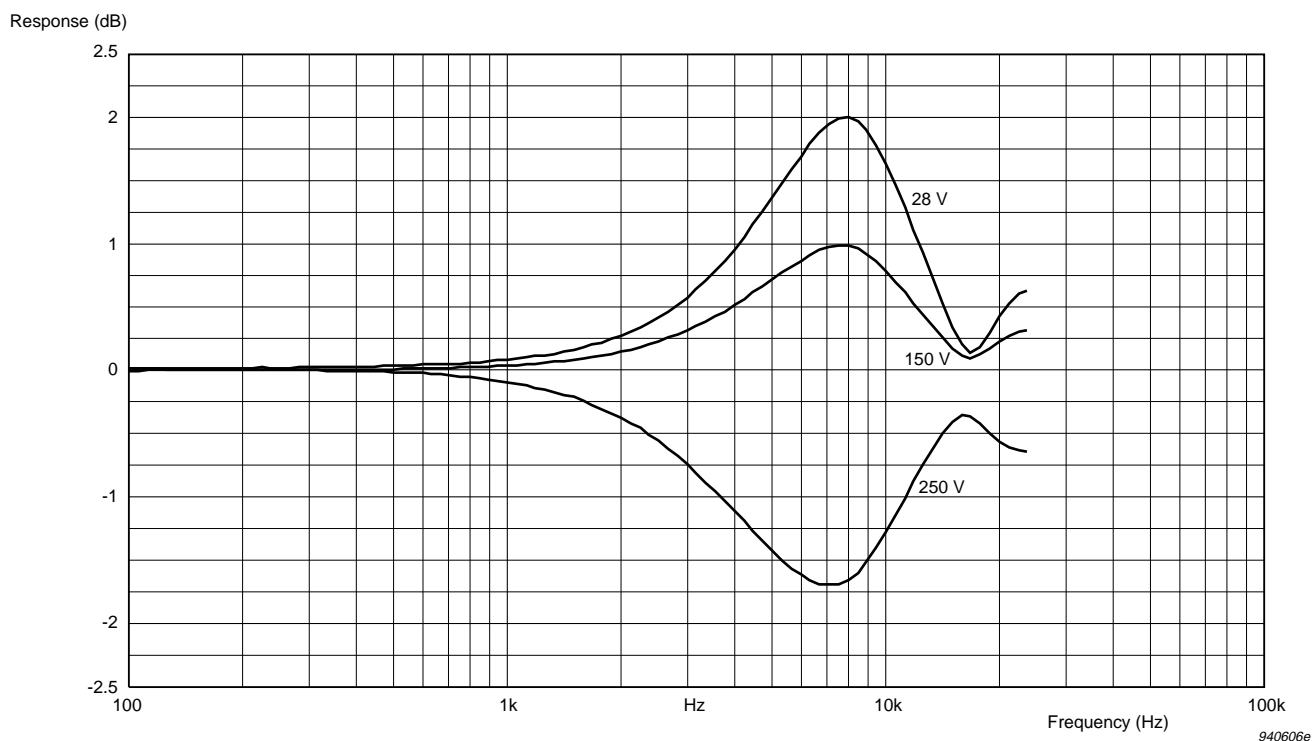

Fig.4.21 Effect of polarization voltage on frequency response. The curves show the difference from the response with a polarization voltage of 200 V (normalised at 250 Hz)

4.9 Leakage Resistance

To maintain the correct polarization voltage on the microphone, the microphone's leakage resistance must be at least 1000 times greater than the supply resistance of the polarization charge, even under the most severe environmental conditions. This resistance which is generally placed in the preamplifier, is typically 10^9 to $10^{10}\ \Omega$. Brüel & Kjær microphones have a very high leakage resistance which is greater than $5 \times 10^{15}\ \Omega$ at 90%RH and 23°C.

4.10 Stability

4.10.1 Mechanical Stability

The microphone's design with respect to mechanical stability is improved compared with traditional Brüel & Kjær microphones. The diaphragm clamping ring is less sensitive to accidental force and the protection grid is significantly reinforced. Therefore, the microphone can withstand mechanical shocks better than traditional Brüel & Kjær microphones.

The sensitivity change of the microphone is less than 0.1 dB after a free fall of 1 m onto a solid hardwood block (re IEC 68-2-32).

This improved mechanical stability makes Free-field $\frac{1}{2}$ " Microphone Type 4190 well-suited for surface mounting and for mounting in small couplers as no mechanical adaptor is required to protect the diaphragm clamping ring. The microphone can be supported by the diaphragm clamping ring directly on the coupler's surface. Any force of less than 5 Newtons will cause a change in sensitivity of less than 0.005 dB. This makes the microphone well-suited for fitting in small, plane wave couplers used for reciprocity calibration and any other small coupler with a well-defined volume.

4.10.2 High-temperature Stability

The diaphragm is made of a stainless steel alloy. The alloy has been carefully selected and is very resistant to heat. This means that the diaphragm tension (and therefore the sensitivity) remain the same, even after several hours' operation at high temperature.

The microphone has been tested at temperatures up to 300°C. Below 170°C, no changes occur. At 170°C, the sensitivity can be permanently changed within the first 10 hours by less than 0.025 dB. After this, the sensitivity can be permanently changed within the next 100 hours by a similar value. At 300°C, the sensitivity can be permanently changed within the first hour by +0.4 dB. After this, the sensitivity can be permanently changed within the next 10 hours by less than +0.4 dB.

Note: Special adaptors (inserted between the microphone and preamplifier) must be made for high-temperature applications in order to protect the preamplifier from heat conduction and radiation.

4.10.3 Long-term Stability

Over a period of time, the mechanical tension in the diaphragm will decrease due to stretching within the foil. This mechanism, which, in principle, causes an increased sensitivity, is, however, very weak for the microphone. Measurement of this mechanism is not possible at room temperature.

At present, no exact value can be given for the microphone's long-term stability but measured changes at high temperatures indicate that Free-field 1/2" Microphone Type 4190 is more than 10 times more stable than traditional Brüel & Kjær microphones. This indicates typical changes of less than 1 dB in 5000 years.

4.11 Effect of Temperature

By careful selection of materials, optimization of the design and artificial ageing, the effect of temperature has been made to be very low.

The microphone has been designed to operate at temperatures from -30 to 300°C . When the microphone is subjected to temperatures above 200°C , it may be discoloured but its functionality will remain unaffected. See [section 4.10.2](#) for permanent changes in sensitivity at temperatures above 170°C .

The reversible changes are shown in Fig.4.22 as a change in sensitivity and in Fig.4.23 to Fig.4.25 as changes in the frequency response normalized at 250 Hz.

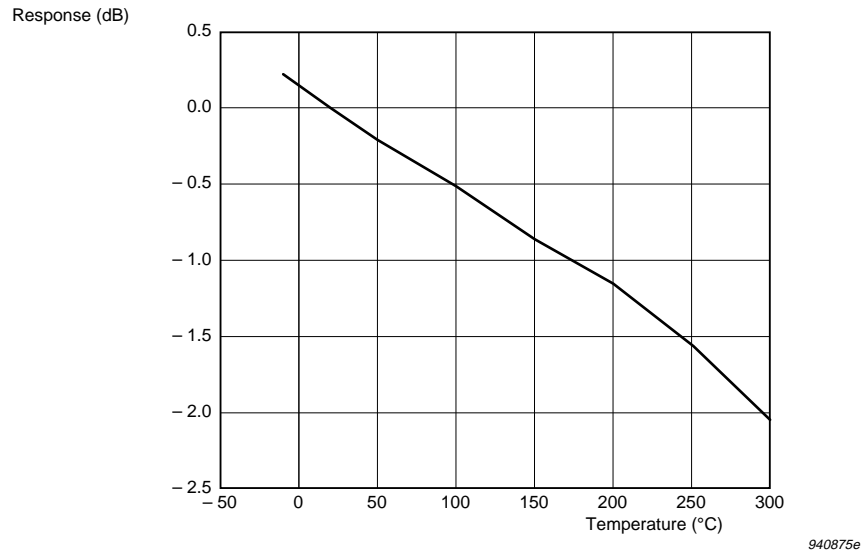

Fig.4.22 Typical variation in sensitivity (at 250 Hz) as a function of temperature, relative to the sensitivity at 20°C

Temperature Coefficient (250 Hz):

-0.007 dB/°C, typical (for the range -10 to +50°C)

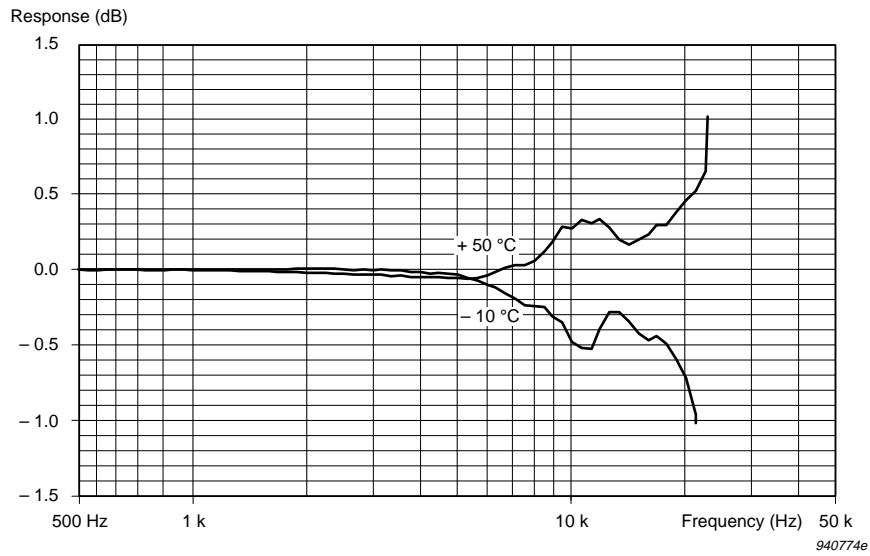

Fig. 4.23 Typical variation in actuator response (normalized at 250 Hz) as a function of temperature, relative to the response at 20°C (see Fig. 4.4) over the temperature range defined by IEC 651

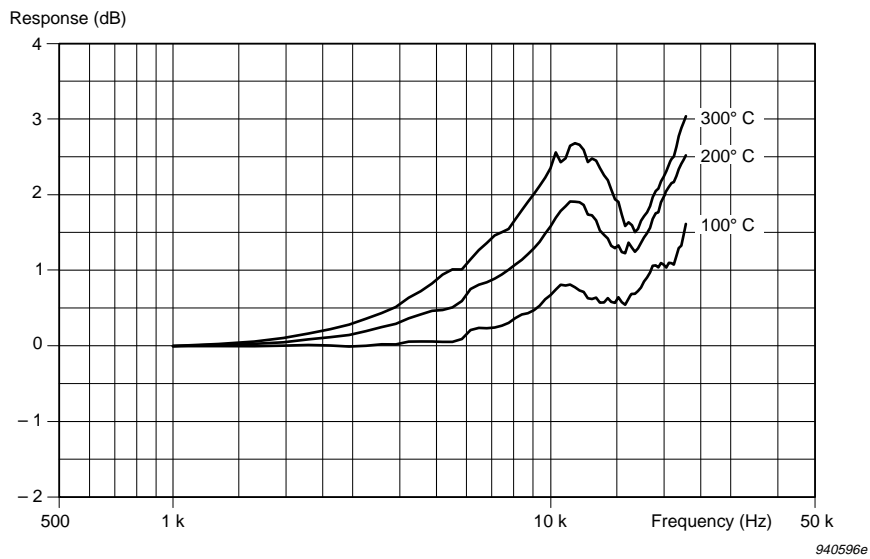

Fig. 4.24 Typical variation in actuator response (normalized at 250 Hz) as a function of temperature, relative to the response at 20°C (see Fig. 4.4)

The effect of temperature on the free-field response (see Fig.4.25) of the microphone is the sum of the following effects:

- the calculated effect of the change in the speed of sound due to temperature on the 0°-incidence free-field correction
- the measured change in the actuator response due to temperature (see Fig.4.23).

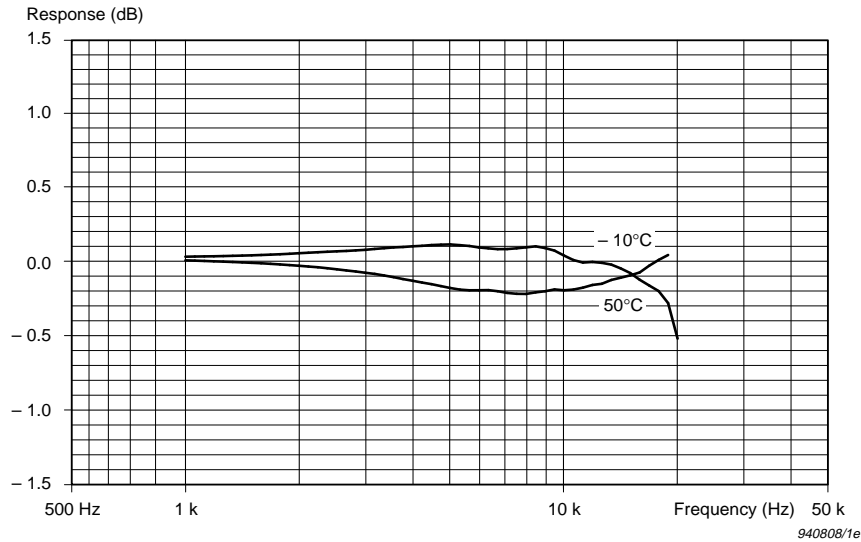

Fig. 4.25 Typical variation in 0°-incidence free-field response (normalized at 250 Hz) as a function of temperature, relative to the response at 20° C (see Fig. 4.7) over the temperature range defined by IEC 651

4.12 Effect of Ambient Pressure

The microphone's sensitivity and frequency response are affected by variations in the ambient pressure. This is due to changes in air stiffness in the cavity behind the diaphragm, and changes in air mass in the small gap between the diaphragm and the back plate. The effects are shown in Fig.4.26 to Fig.4.28.

The typical pressure coefficient at 250 Hz for Free-field 1/2" Microphone Type 4190 is -0.010 dB/kPa, well within the ± 0.03 dB/kPa limits required for Type 0 and Type 1 sound level meters by IEC 651.

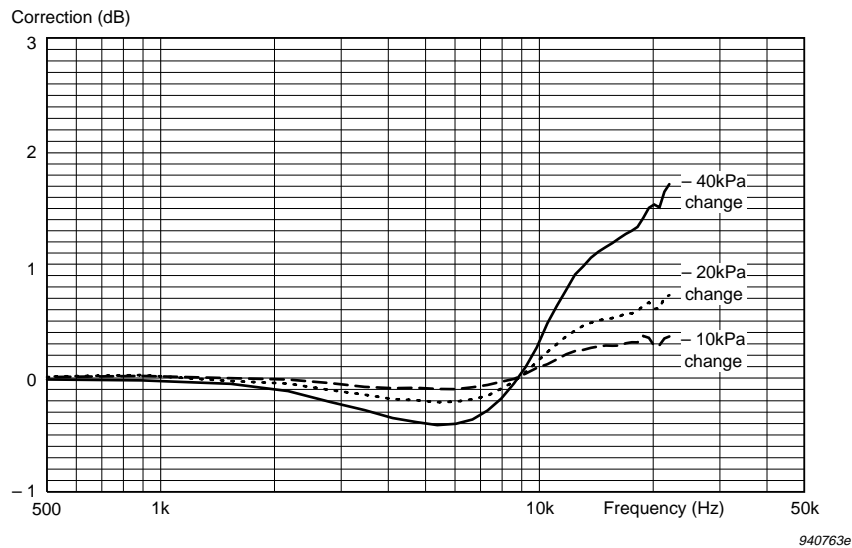

Fig.4.26 Typical variation in frequency response (normalized at 250 Hz) from that at 101.3 kPa as a function of change in ambient pressure

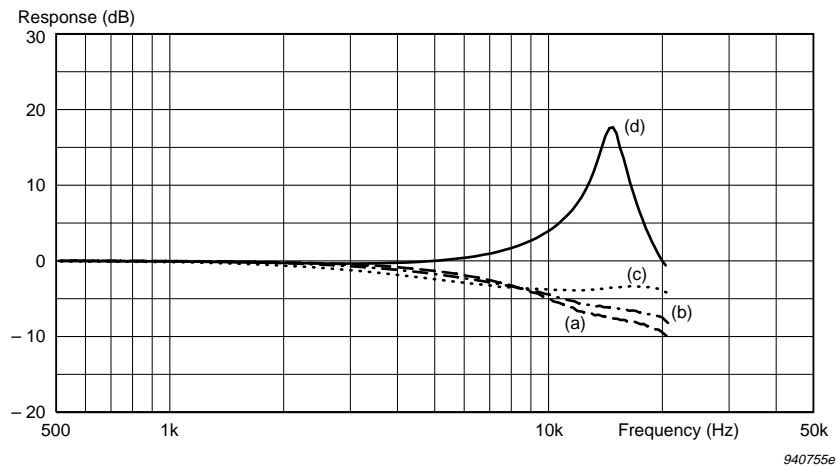

Fig.4.27 Typical effect of ambient pressure on actuator response (normalized at 250 Hz) (a) at 101.3 kPa (b) -40 kPa change (c) -80 kPa change (d) at 2 kPa

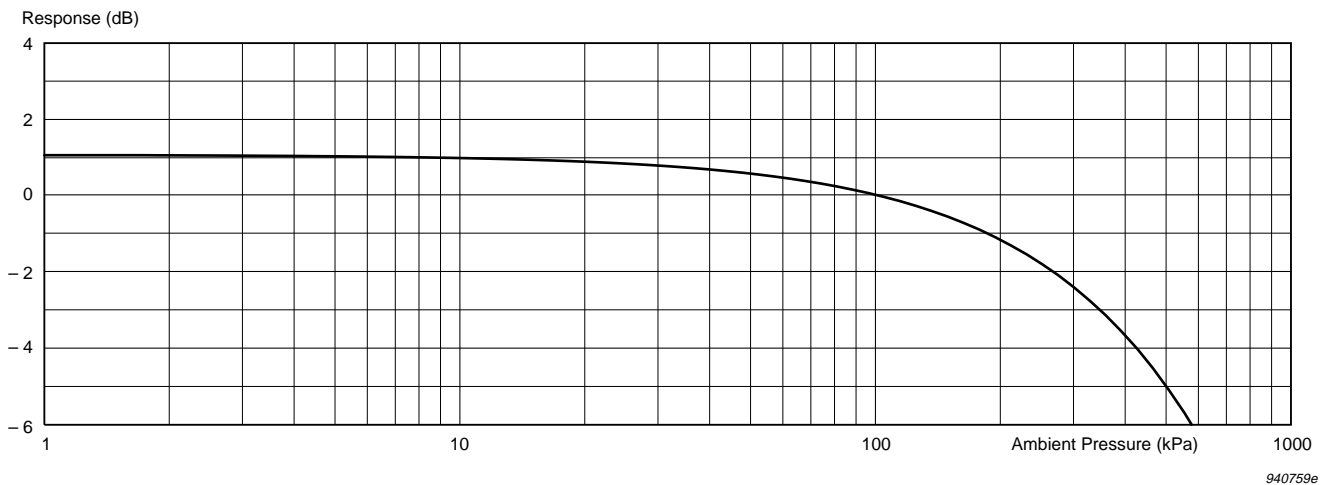

Fig. 4.28 Typical variation in sensitivity at 250 Hz from that at 101.3 kPa as a function of ambient pressure

4.13 Effect of Humidity

Due to the microphone's high leakage resistance, humidity has, in general, no effect on the microphone's sensitivity or frequency response. The microphone has been tested according to IEC 68-2-3 and the effects of humidity on the sensitivity at 250 Hz and the frequency response have been found to be less than 0.1 dB at up to 95% RH (non-condensing) and 40°C.

4.14 Effect of Vibration

The effect of vibration is determined mainly by the mass of the diaphragm and is at its maximum for vibrations applied normal to the diaphragm. A vibration signal of 1 m/s^2 RMS normal to the diaphragm typically produces an equivalent Sound Pressure Level of 62.5 dB for a microphone fitted with Protection Grid DB 3420.

4.15 Effect of a Magnetic Field

The effect of a magnetic field is determined by the vector field strength and is normally at its maximum when the field direction is normal to the diaphragm. A magnetic field strength of 80 A/m at 50 Hz (the test level recommended by IEC and ANSI) normal to the diaphragm produces a typical equivalent Sound Pressure Level of 4 dB. Higher frequency components in the microphone output become dominant at field strengths greater than 500 to 1000 A/m.

4.16 Electromagnetic Compatibility

See [Chapter 8](#).

4.17 Specifications Overview

<p>OPEN-CIRCUIT SENSITIVITY (250 Hz)*: -26 dB ±1.5 dB re 1 V/Pa, 50 mV/Pa*</p> <p>POLARIZATION VOLTAGE: External: 200 V</p> <p>FREQUENCY RESPONSE*: 0° incidence free-field response: 5 Hz to 10 kHz: ±1 dB 3.15 Hz to 20 kHz: ±2 dB In accordance with IEC 651, Type 0 and Type 1</p> <p>LOWER LIMITING FREQUENCY (-3 dB): 1 Hz to 2 Hz (vent exposed to sound)</p> <p>PRESSURE EQUALIZATION VENT: Rear vented</p> <p>DIAPHRAGM RESONANCE FREQUENCY: 14 kHz, typical (90° phase shift)</p> <p>CAPACITANCE (POLARIZED)*: 16 pF, typical (at 250 Hz)</p> <p>EQUIVALENT AIR VOLUME (101.3 kPa): 46 mm³</p> <p>_____</p> <p>* Individually calibrated</p>	<p>CALIBRATOR LOAD VOLUME (250 Hz): 250 mm³</p> <p>PISTONPHONE TYPE 4228 CORRECTION: with DP 0776: 0.00 dB</p> <p>TYPICAL CARTRIDGE THERMAL NOISE: 14.6 dB (A) 15.3 dB (Lin.)</p> <p>UPPER LIMIT OF DYNAMIC RANGE: 3% distortion: >148 dB SPL</p> <p>MAXIMUM SOUND PRESSURE LEVEL: 159 dB (peak)</p> <p>OPERATING TEMPERATURE RANGE: -30 to +150°C (-22 to 302°F) can be used up to +300°C (572°F) but with a permanent sensitivity change of typically +0.4 dB which stabilises after one hour</p> <p>OPERATING HUMIDITY RANGE: 0 to 100% RH (without condensation)</p> <p>STORAGE TEMPERATURE: -30 to +70°C (-22 to 158°F)</p> <p>TEMPERATURE COEFFICIENT (250 Hz): -0.007 dB/°C, typical (for the range -10 to +50°C)</p>	<p>PRESSURE COEFFICIENT (250 Hz): -0.010 dB/kPa, typical</p> <p>INFLUENCE OF HUMIDITY: <0.1 dB/100%RH</p> <p>VIBRATION SENSITIVITY (<1000 Hz): Typically 62.5 dB equivalent SPL for 1 m/s² axial acceleration</p> <p>MAGNETIC FIELD SENSITIVITY: Typically 4 dB SPL for 80 A/m, 50 Hz field</p> <p>ESTIMATED LONG-TERM STABILITY: >1 000 years/dB at 20°C >1 00 hours/dB at 150°C</p> <p>DIMENSIONS: Diameter: 13.2 mm (0.52 in) (with grid) 12.7 mm (0.50 in) (without grid) Height: 17.6 mm (0.68 in) (with grid) 16.3 mm (0.64 in) (without grid) Thread for preamplifier mounting: 11.7 mm – 60 UNS</p> <p>The data above are valid at 23°C, 101.3 kPa and 50%RH, unless otherwise specified.</p>
--	---	--

4.18 Ordering Information

Preamplifier

Type 2669: 1/2" Microphone Preamplifier

Calibration Equipment

Type 4231: Sound Level Calibrator

Type 4226: Multifunction Acoustic Calibrator

Type 4228: Pistonphone

UA 0033: Electrostatic Actuator

Other Accessories

UA 0308: Dehumidifier

UA 0254: Set of 6 Windscreens (UA 0237) 90 mm (3.5 in)

UA 0469: Set of 6 Windscreens (UA 0459) 65 mm (2.6 in)

Chapter 5

Free-field 1/2" Microphone Type 4191

5.1 Introduction

5.1.1 Description



Fig. 5.1 Free-field $\frac{1}{2}$ " Microphone Type 4191 with Protection Grid DB 3421 (included)

Free-field $\frac{1}{2}$ " Microphone Type 4191 is an externally-polarized microphone for general sound measurements and for standardized noise measurements in accordance with the requirements of IEC 651 Type 0 and Type 1. With its low inherent noise and frequency range from 3.15 Hz to 40 kHz, it is very well suited for a wide range of precision audio-frequency sound measurements and electro-acoustic measurements on loudspeakers and microphones.

The microphone requires a polarization voltage of 200 V, provided by the instrument or analyzer powering the associated preamplifier.

This rugged microphone is built to ensure high stability under a variety of conditions. For example, the stainless steel alloy diaphragm withstands polluted industrial environments. The diaphragm clamping ring is firmly secured to ensure the microphone's reliability, even when the microphone is used without its protection grid. When the microphone is used without its protection grid, it can be easily flush-mounted or inserted into closed volumes as it can be supported by the diaphragm clamping ring, provided that a force of less than 5 Newtons is applied.

The microphone is supplied with individual calibration data on a calibration chart and on a $3\frac{1}{2}$ " data disk in a case. This case can also contain a $\frac{1}{2}$ " Microphone Preamplifier Type 2669.

5.1.2 The Calibration Chart

Each microphone is supplied with an individual calibration chart (see Fig. 5.2) which gives the microphone's open-circuit sensitivity, polarized capacitance and free-field and actuator frequency responses.

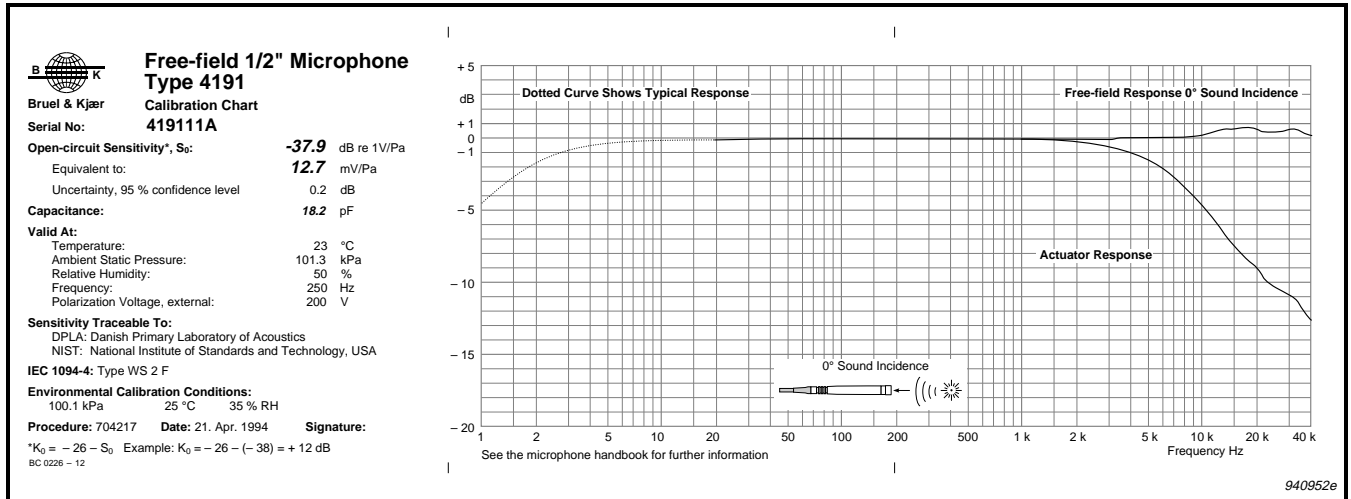

Fig. 5.2 Microphone calibration chart

Open-circuit Sensitivity

The stated open-circuit sensitivity is valid at the reference frequency (251.2 Hz^{*}) for free-field, random-incidence and pressure-field conditions. The stated uncertainty is the U₉₅ value (the value valid for 95% confidence level).

Ambient Conditions

The ambient conditions are measured continuously during calibration at the factory. The calibration results obtained at the measured Environmental Calibration Conditions are corrected to the reference ambient conditions stated under Valid At (23°C, 101.325 kPa and 50% RH).

Frequency Responses

Two frequency responses are shown on the calibration chart. Both are normalized to 0 dB at the reference frequency (251.2 Hz^{*}).

The upper curve on the calibration chart is the individual microphone's open-circuit 0°-incidence free-field response. This response is the optimized response for Free-field $\frac{1}{2}$ " Microphone Type 4191.

*The exact reference frequency is 10^{2.4} Hz (re ISO 266).

The lower curve on the calibration chart is the individual microphone's electrostatic actuator response measured with Electrostatic Actuator UA 0033. This response is used to determine free-field responses at angles of incidence other than 0° and responses in other types of sound field. The individual microphone's electrostatic actuator response is also available on the data disk.

The dotted part of the curve is the typical low-frequency response. Each microphone's individual lower limiting frequency is measured to ensure that it is within the specified tolerances (see Fig. 5.3).

5.1.3 Data Disk

The 3 1/2" data disk supplied with each microphone supplements the calibration chart. It contains individual calibration data and correction curves (see Table 5.1) with a frequency resolution of 1/12-octave as comma-separated ASCII text files under the \DATA directory.

File Name	Content	Frequency Range
S#####.BKM ^a	Sensitivity calibration	251.2 Hz
A#####.BKM ^a	Actuator response	200 Hz – 40 kHz
F#####.BKR ^b	Free-field response	1 Hz – 40 kHz
4191L.BKT ^c	Low-frequency response	1 Hz – 190 Hz
4191F.BKC ^d	Free-field corrections without protection grid	200 Hz – 40 kHz
4191FG.BKC ^d	Free-field corrections with protection grid	200 Hz – 40 kHz
4191R.BKC ^d	Random-incidence corrections without protection grid	200 Hz – 40 kHz
4191RG.BKC ^d	Random-incidence corrections with protection grid	200 Hz – 40 kHz
4191P.BKC ^d	Pressure-field corrections	200 Hz – 22 kHz

Table 5.1 Calibration data and corrections contained on the data disk. Note: ##### is the microphone's serial number

a. Individual calibration data (measured).

b. Low-frequency response combined with actuator response and free-field corrections.

c. Typical response for Free-field 1/2" Microphone Type 4191.

d. Corrections for Free-field 1/2" Microphone Type 4191.

These text files can be viewed on Microsoft® Windows™ using the Brüel & Kjær Microphone Viewer program (BK-MIC.EXE) supplied on the disk. They can also be accessed by a suitable spreadsheet for further processing or printing.

Brüel & Kjær Microphone Viewer must be installed before use (see section 1.3.5).

5.1.4 Recommended Recalibration Interval

With normal handling of the microphone and any associated instrument, Brüel & Kjær recommends that the microphone be recalibrated every 2 years.

Free-field 1/2" Microphone Type 4191 is very stable over this period (see [section 5.10](#) to [section 5.12](#)). Improper handling is by far the most likely cause of change in the microphone's properties. Any damage which causes improper operation can probably be detected using a sound level calibrator. In many cases, the damage can be seen by carefully inspecting the protection grid and diaphragm.

5.2 Sensitivity

5.2.1 Open-circuit Sensitivity

The open-circuit sensitivity is defined as the sensitivity of the microphone when not loaded by the input impedance of the connected preamplifier (the termination is described in IEC 1094-2). The sensitivity is measured for the individual microphone at 251.2 Hz and stated on the microphone's calibration chart (see [section 5.1.2](#)) and data disk (see [section 5.1.3](#)). The nominal sensitivity is shown in [Table 5.2](#).

Nominal open-circuit sensitivity		Accepted Deviation (dB)
mV/Pa	dB re 1 V/Pa	
12.5	-38	±1.5

Table 5.2 Nominal open-circuit sensitivity

5.2.2 Loaded Sensitivity

When loaded by a preamplifier, the sensitivity of the microphone is given by:

$$S_C = S_O + G \quad (5.1)$$

where

- S_C = overall sensitivity of microphone and preamplifier combination
- S_O = open-circuit sensitivity of microphone
- G = voltage gain of microphone and preamplifier combination (in dB)

With Microphone Preamplifier Type 2639: $G = -0.1$ dB

With 1/2" Microphone Preamplifier Type 2669: $G = -0.2$ dB

Example

Loaded sensitivity of typical microphone with 1/2" Microphone Preamplifier Type 2669:

$$S_C = -38.3 + (-0.2) = -38.5 \text{ dB}$$

5.2.3 K-factor

Some types of Brüel & Kjær instruments use the K-factor (correction factor) or the K_O -factor (open-circuit correction factor) for calibration.

$$K = -26 - S_C \quad (5.2)$$

$$K_O = -26 - S_O \quad (5.3)$$

Example

Correction factor for typical microphone with 1/2" Microphone Preamplifier Type 2669:

$$K = -26 - (-38.5) = +12.5 \text{ dB}$$

Open-circuit correction factor for typical microphone with 1/2" Microphone Preamplifier Type 2669:

$$K_O = -26 - (-38.3) = +12.3 \text{ dB}$$

5.3 Frequency Response

5.3.1 General

In acoustic measurements, there are three types of sound field:

- Free field
- Pressure field
- Diffuse field

The microphone is optimized to have a flat frequency response in one of these sound fields. This response is called the optimized response. A microphone's response in a diffuse field is equivalent to its random-incidence response.

This section shows the microphone's typical free-field, pressure-field and random-incidence responses together with the microphone's typical actuator response obtained using Electrostatic Actuator UA 0033. The low-frequency response described in [section 5.3.4](#) is common for all types of response.

All frequency responses and correction curves are shown with a frequency resolution of $\frac{1}{12}$ -octave.

5.3.2 Optimized Response (0° -incidence Free-field Response)

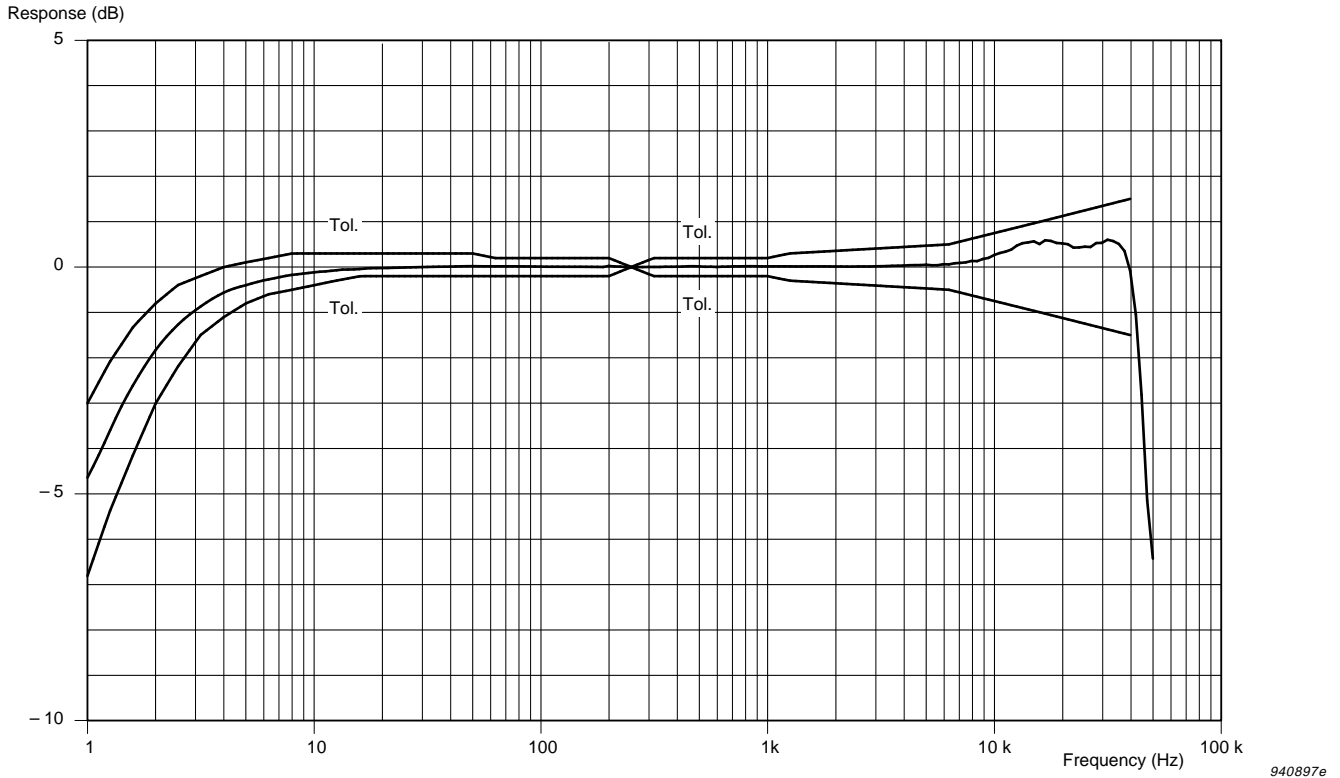

Fig. 5.3 Typical free-field response of the microphone with Protection Grid DB 3421 and the microphone's specified tolerances. The low-frequency response is valid when the vent is exposed to the sound field

The frequency response of Free-field $\frac{1}{2}$ " Microphone Type 4191 meets the requirements of IEC 651 Type 0 and Type 1, and ANSI S1.12 Type M.

5.3.3 Actuator Response

The microphone's frequency response is determined by adding corrections for the type of sound field to its actuator response obtained using Electrostatic Actuator UA 0033. This is a reproducible and practical method for calibrating a microphone's frequency response.

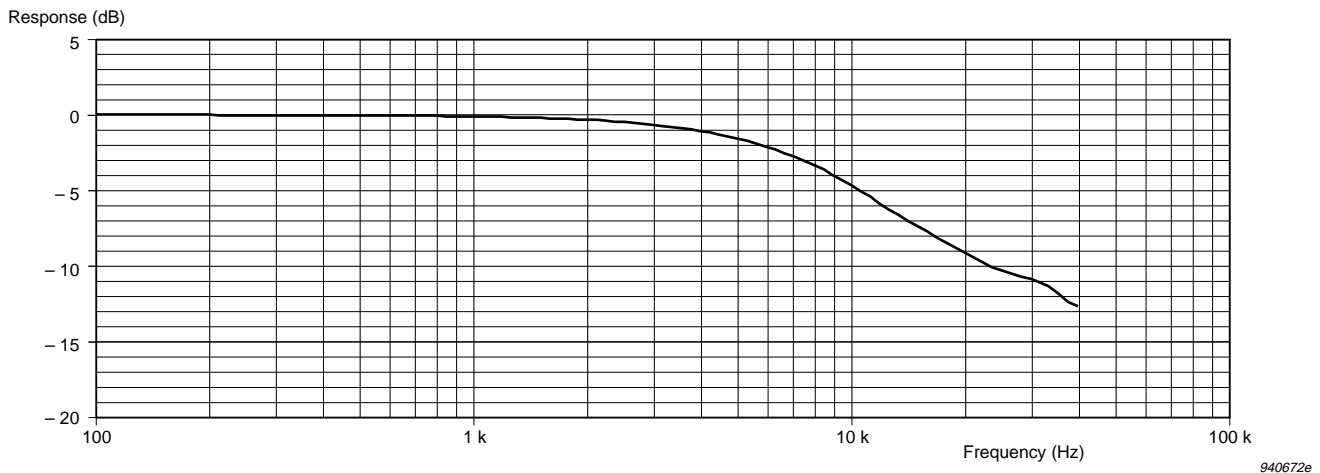

Fig. 5.4 Typical actuator response (magnitude) measured with Electrostatic Actuator UA 0033

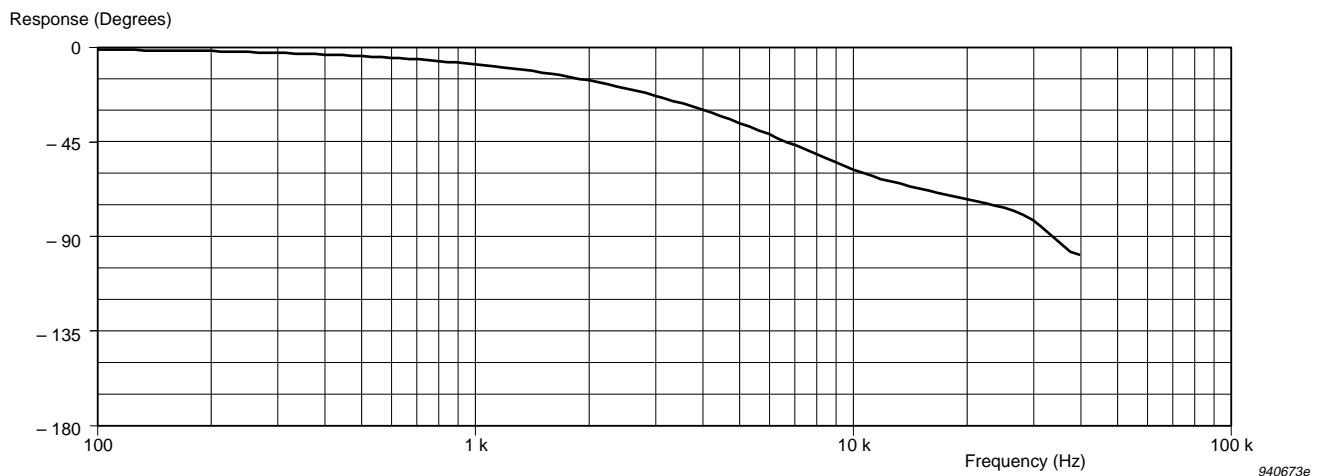

Fig. 5.5 Typical actuator response (phase) measured with Electrostatic Actuator UA 0033

If the polarization voltage is positive (as it is with Brüel & Kjær instruments), the output voltage is negative for a positive pressure applied to the diaphragm.

5.3.4 Low-frequency Response

The low-frequency response (see Fig. 5.3) is the typical response with the vent exposed to the sound field. If the vent is not exposed to the sound field, the sensitivity increases from 0 dB at the reference frequency (251.2 Hz) to approximately 0.2 dB at 1 Hz.

For applications where the vent is not exposed to the sound field, take care to ensure proper static pressure equalization to prevent static displacement of the diaphragm.

The microphone's low-frequency response is common for all types of sound field.

The microphone's lower limiting frequency (-3 dB) is between 1 and 2 Hz with the vent exposed to the sound field. This is measured during production to ensure that specifications are fulfilled.

5.3.5 Free-field Response

The microphone's free-field correction curves are shown in [Fig. 5.6](#) and [Fig. 5.8](#). These corrections are added to the microphone's actuator response obtained using Electrostatic Actuator UA 0033 in order to determine the free-field response at any angle of incidence. The typical free-field response at 0° incidence with and without the protection grid are shown in [Fig. 5.7](#) and [Fig. 5.9](#).

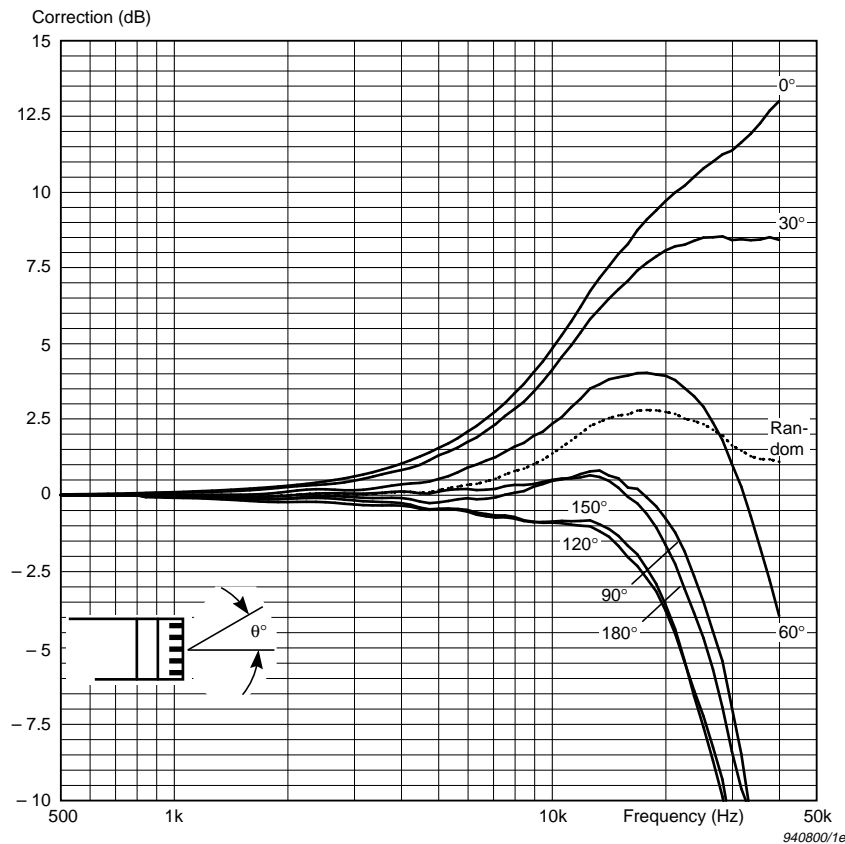

Fig. 5.6 Free-field correction curves for the microphone with Protection Grid DB 3421

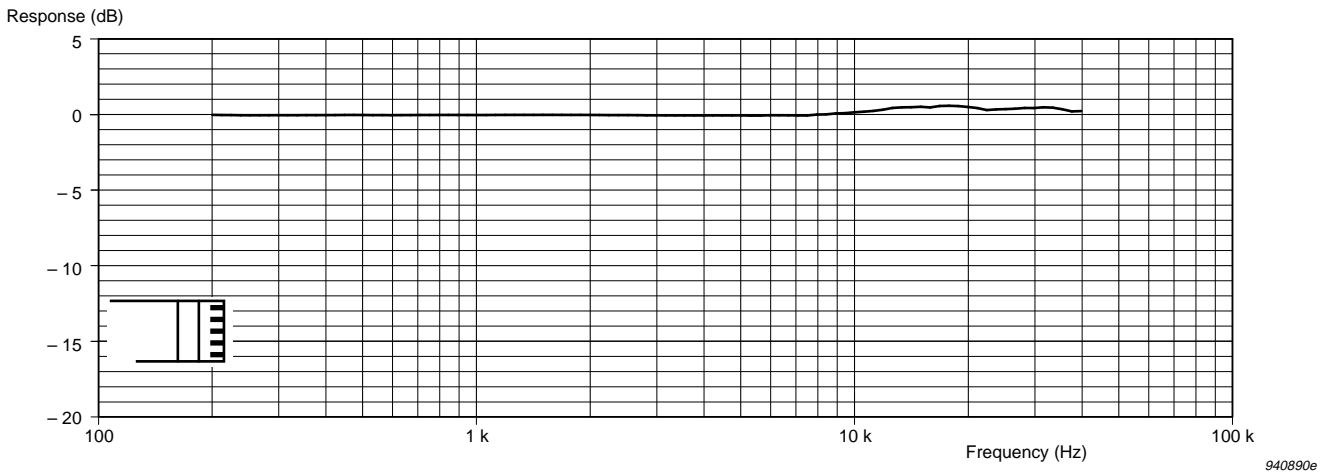

Fig 5.7 Typical free-field response (0° incidence) for the microphone with Protection Grid DB 3421

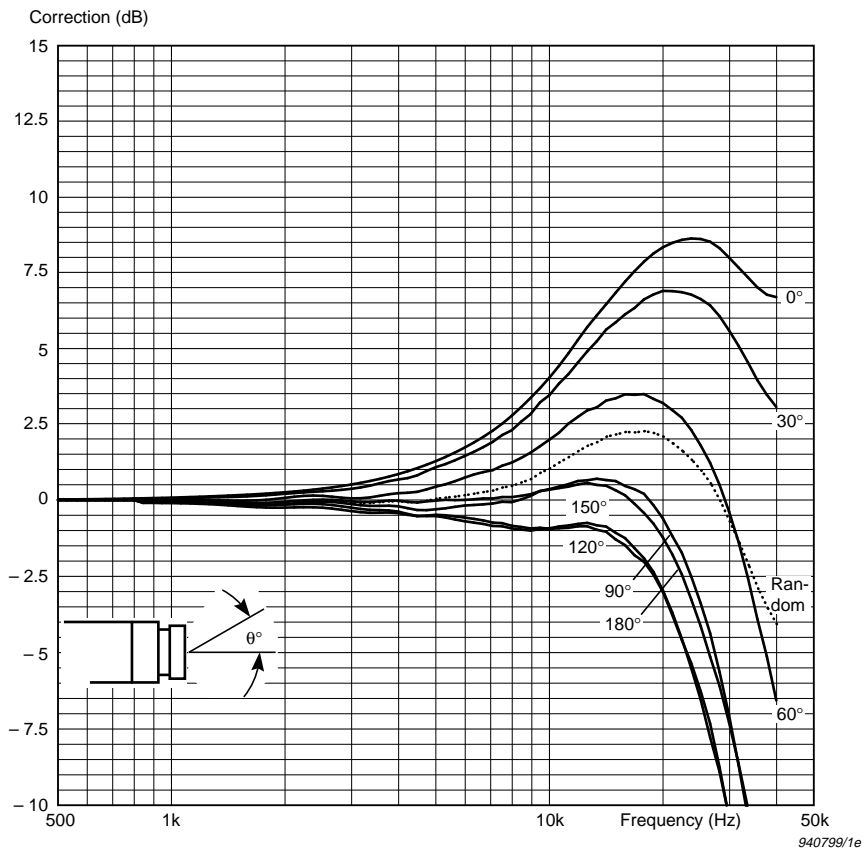

Fig 5.8 Free-field correction curves for the microphone without protection grid

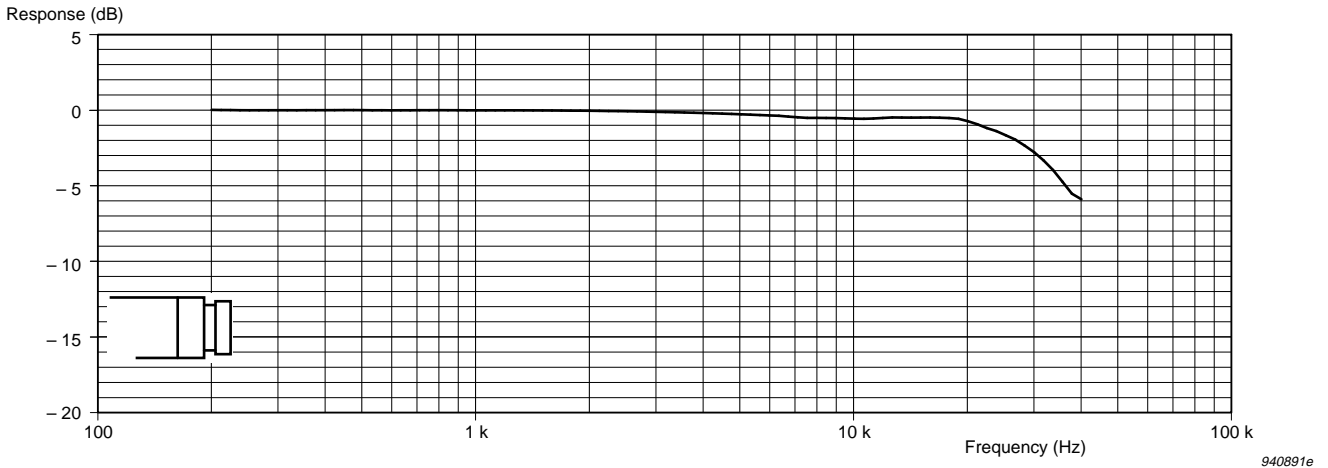

Fig. 5.9 Typical free-field response (0° incidence) for the microphone without protection grid

5.3.6 Random-incidence Response

A microphone's response in a diffuse sound field is equivalent to its random-incidence response. The microphone's random-incidence correction curves are shown in [Fig. 5.6](#) and [Fig. 5.8](#). These corrections are added to the microphone's actuator response obtained using Electrostatic Actuator UA 0033 in order to determine the random-incidence response. The typical random-incidence response with and without the protection grid are shown in [Fig. 5.10](#) and [Fig. 5.11](#).

The random-incidence corrections are calculated from the free-field corrections measured in 5° steps according to Draft IEC 1183–1993.

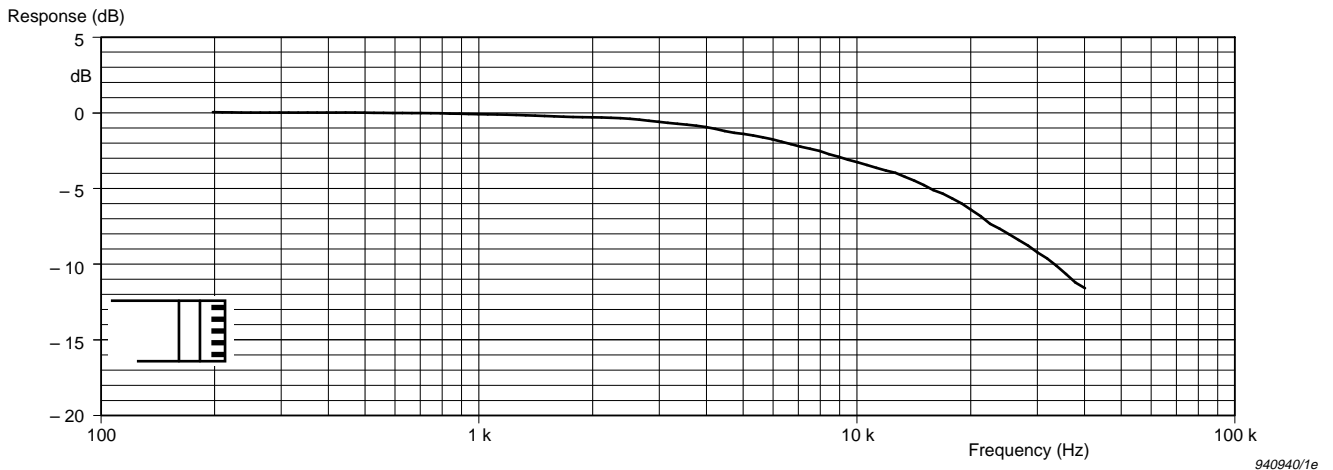

Fig. 5.10 Typical random-incidence response for the microphone with Protection Grid DB 3421

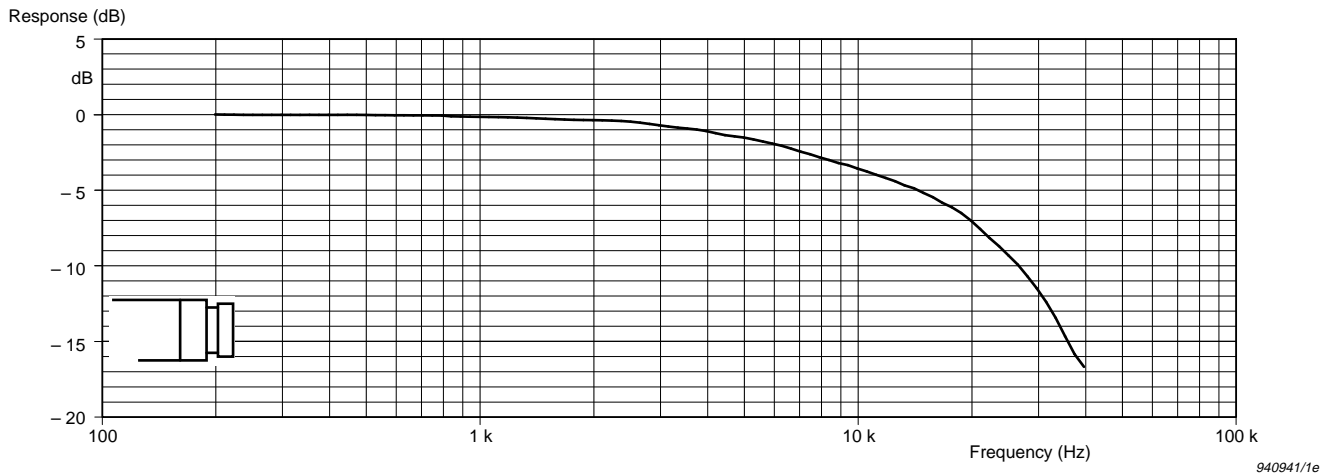

Fig. 5.11 Typical random-incidence response for the microphone without protection grid

5.3.7 Pressure-field Response

The microphone's pressure-field correction curve is shown in Fig. 5.12. This correction is added to the microphone's actuator response obtained using Electrostatic Actuator UA 0033 in order to determine the pressure-field response. The typical pressure-field response is shown in Fig. 5.13.

In practice, the pressure-field response is often regarded as being equal to the actuator response as the difference between them is small compared to the uncertainty related to many types of measurement.

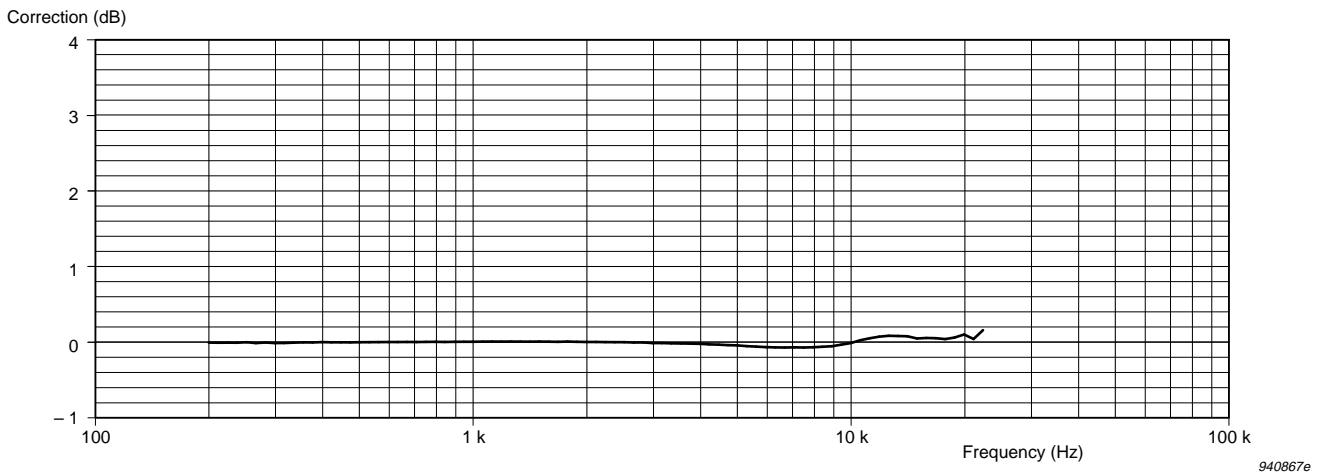

Fig. 5.12 Pressure-field correction for the microphone

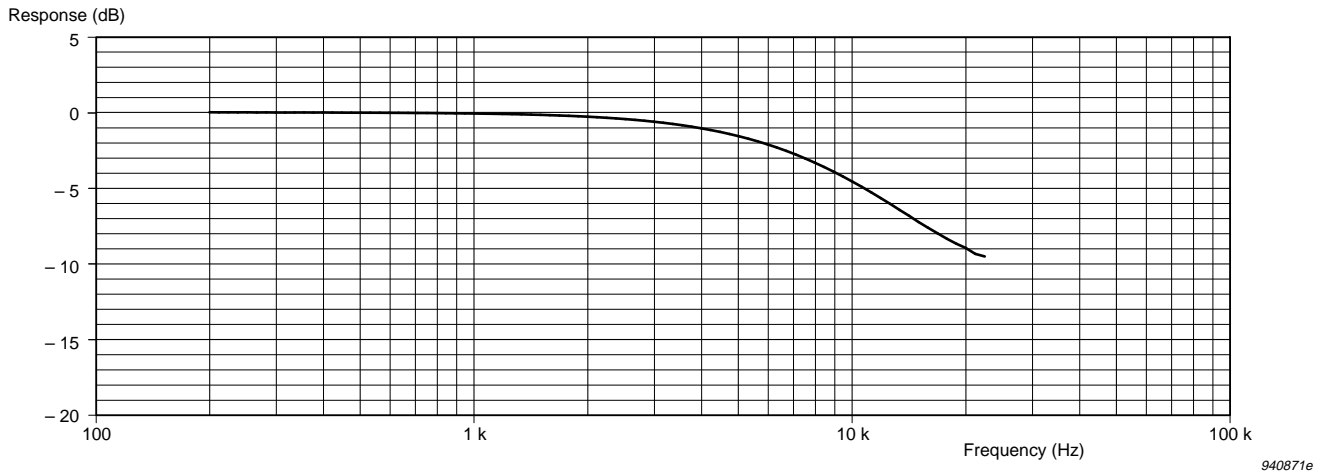

Fig. 5.13 Typical pressure-field response for the microphone

5.4 Directional Characteristics

Typical directional characteristics are given in [Fig. 5.14](#) and [Fig. 5.15](#). The characteristics are normalised relative to the 0° response.

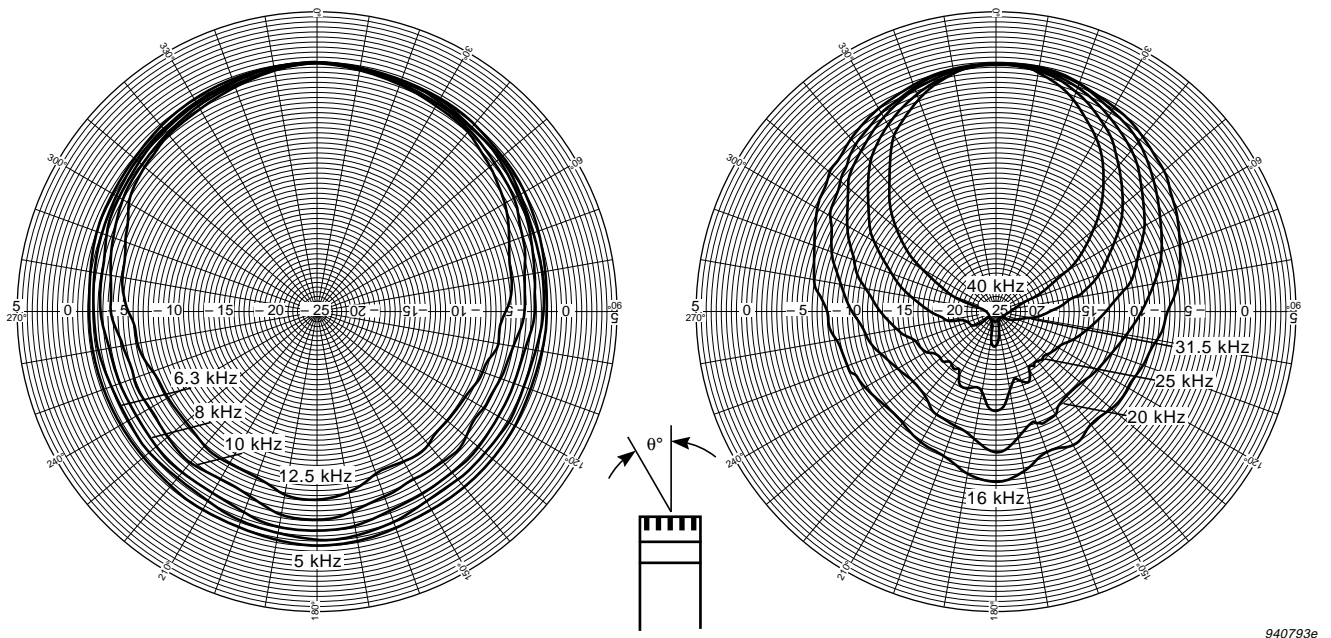
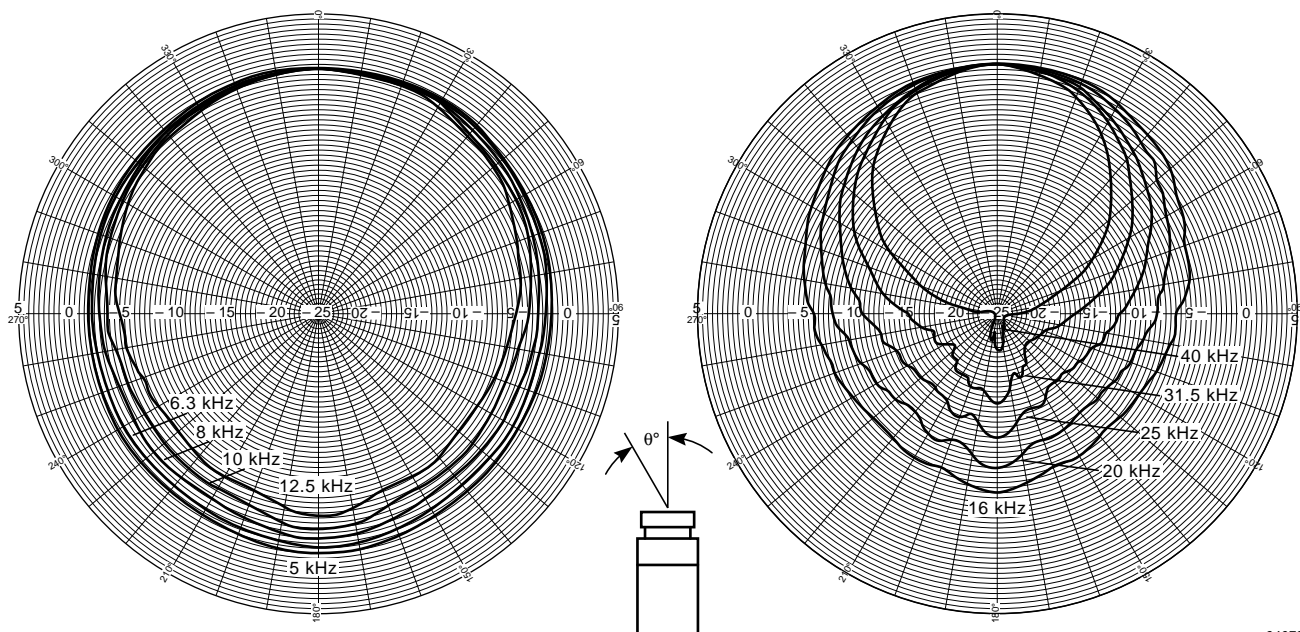

Fig. 5.14 Typical directional characteristics of the microphone with Protection Grid DB 3421



940792e

Fig. 5.15 Typical directional characteristics of the microphone without protection grid

5.5 Dynamic Range

Definition

The dynamic range is the range between the upper limit (determined by distortion) and the inherent noise floor. Both limits are influenced by the preamplifier. This section gives values for the microphone with and without a preamplifier.

Inherent Noise

The microphone's inherent noise is due to thermal movements of the diaphragm. These vary proportionally with the square root of the absolute temperature (in °K). The inherent noise increases with increasing temperature. With reference to 20 °C, the inherent noise changes by +0.5 dB at 55 °C and by -0.5 dB at -12 °C. The maximum variation of this noise for different samples of Free-field $\frac{1}{2}$ " Microphone Type 4191 is ± 1 dB.

The preamplifier's effect on the inherent noise of the combined microphone and preamplifier depends on the sensitivity and capacitance of the microphone (for 1/2" Microphone Preamplifier Type 2669, see Fig. 5.16 and [Chapter 8](#)).

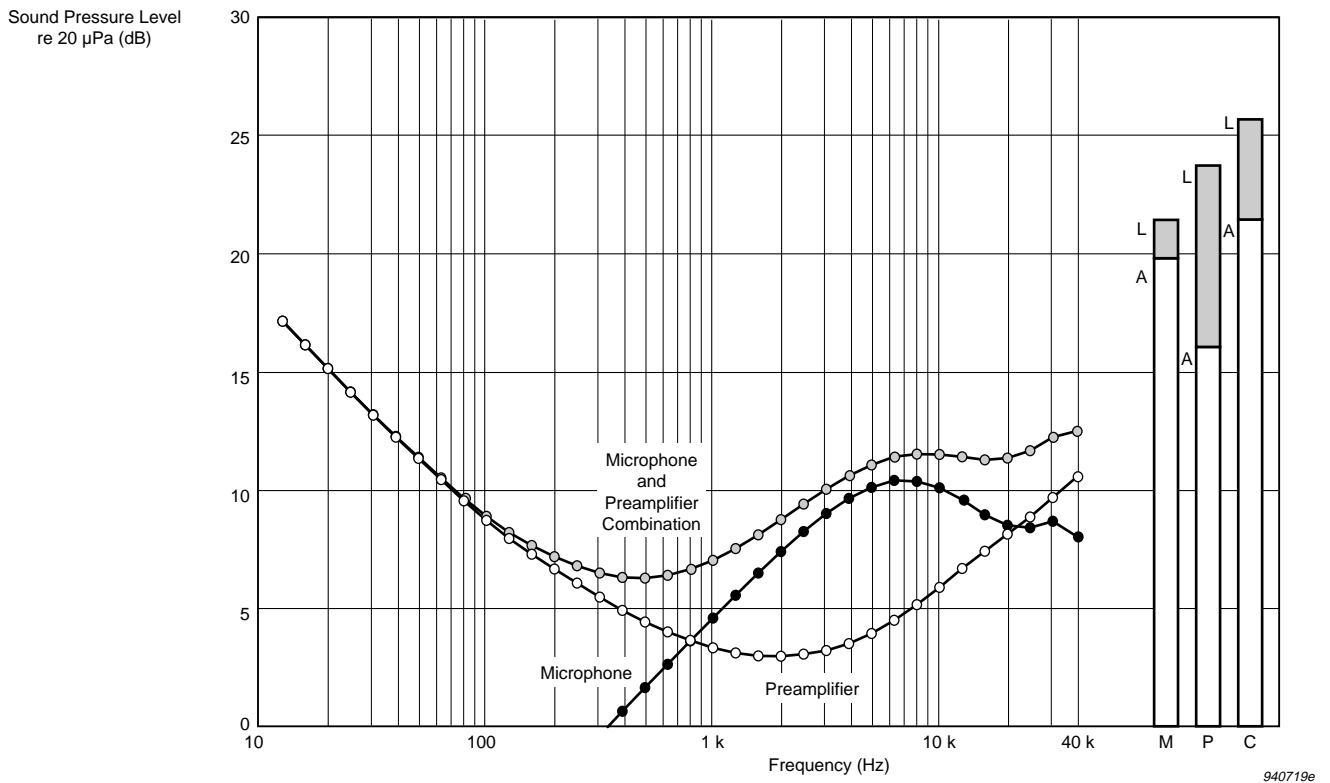

Fig. 5.16 1/3-octave-band inherent noise spectrum. The shaded bar graphs are the broad-band (20Hz to 40kHz) noise levels and the white bar graphs the A-weighted noise levels of the microphone (M), 1/2" Microphone Preamplifier Type 2669 (P) and microphone and preamplifier combination (C)

Distortion

The distortion is determined mainly by the microphone but, at the highest operation levels, the preamplifier also contributes to the distortion (see Fig. 5.17).

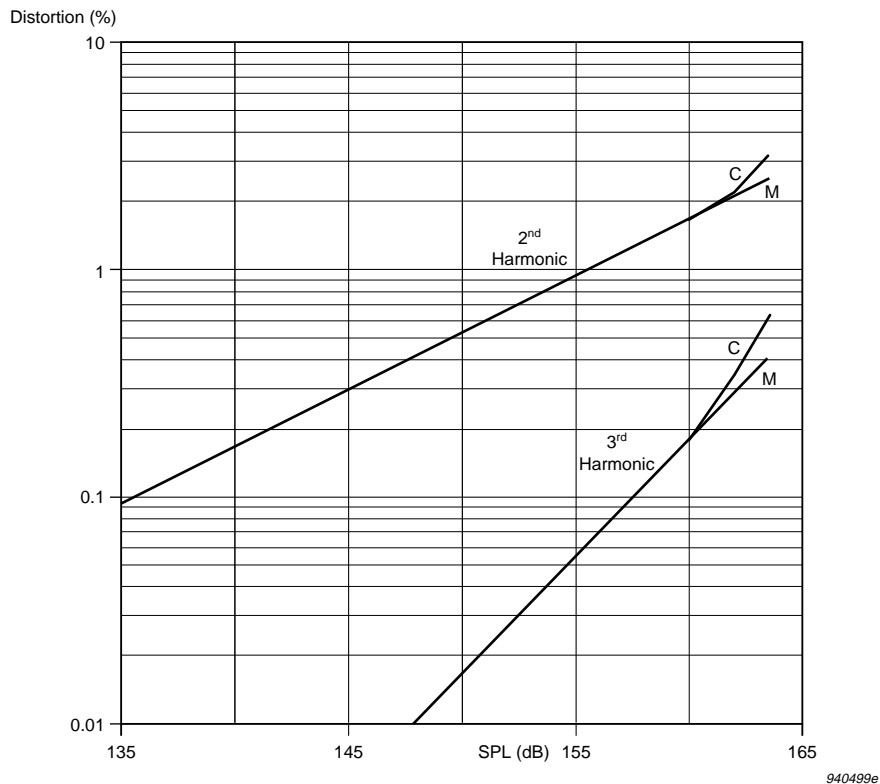

Fig. 5.17 Typical distortion characteristics of the microphone with 1/2" Microphone Preamplifier Type 2669 (C) and unloaded (M)

The distortion is dependent on the capacitance parallel to the microphone. It increases with increasing capacitance. The distortions given in [Table 5.3](#) and [Table 5.4](#) are valid for a parallel capacitance of 0.5 pF. The distortion is measured at 100 Hz but can be assumed to be valid up to approximately 5 kHz (that is, where the diaphragm displacement is predominantly stiffness-controlled). Distortion measurement methods for higher frequencies are not available.

Maximum Sound Pressure Level

In general, the microphone should not be exposed to sound pressure levels which produce voltages higher than the maximum input voltage specified for the connected preamplifier. After an overload, the preamplifier needs time to recover and, during this recovery period, you cannot measure validly. The maximum input voltage for most Brüel & Kjær preamplifiers is ± 50 V (with a 130 V supply). This voltage is

Lower Limit				Upper Limit	
1 Hz bandwidth at 1 kHz (dB)	1/3-octave at 1 kHz (dB)	A-weighted (dB)	Linear 20 Hz to 40 kHz (dB)	< 3% distortion (dB)	Max. SPL (Peak) (dB)
-19.0	4.6	20.0	21.4	162	171

Table 5.3 Dynamic range of the microphone

Lower Limit				Upper Limit	
1 Hz bandwidth at 1 kHz (dB)	1/3-octave at 1 kHz (dB)	A-weighted (dB)	Linear 20 Hz to 40 kHz (dB)	< 3% distortion (dB)	Max. SPL (Peak) (dB)
-16.5	7.1	21.4	25.8	161	166

Table 5.4 Dynamic range of the microphone with 1/2" Microphone Preamplifier Type 2669

produced by a nominal Free-field 1/2" Microphone Type 4191 at a Peak level of 166 dB (re 20 µPa).

The microphone will maintain its charge up to a Peak level of 171 dB (re 20 µPa). Above this level, the diaphragm and back plate short-circuit. If this occurs, the microphone needs one or two minutes to recharge before it is ready to measure validly. We recommend not to expose Free-field 1/2" Microphone Type 4191 to levels higher than 171 dB (Peak).

5.6 Equivalent Volume and Calibrator Load Volume

Equivalent Volume

For some applications it is practical to express the acoustic impedance of the microphone diaphragm in terms of a complex equivalent volume. This makes it easier to evaluate the effect of microphone loading on closed cavities or acoustic calibration couplers.

The real and imaginary parts of the equivalent volume shown in [Fig.5.18](#) are in parallel. They are calculated from a simple R-L-C series model of the microphone which gives the best overall approximation of the microphone's diaphragm impedance.

The Models

The following equivalent models are valid at 101.325 kPa, 23 °C and 50%RH:

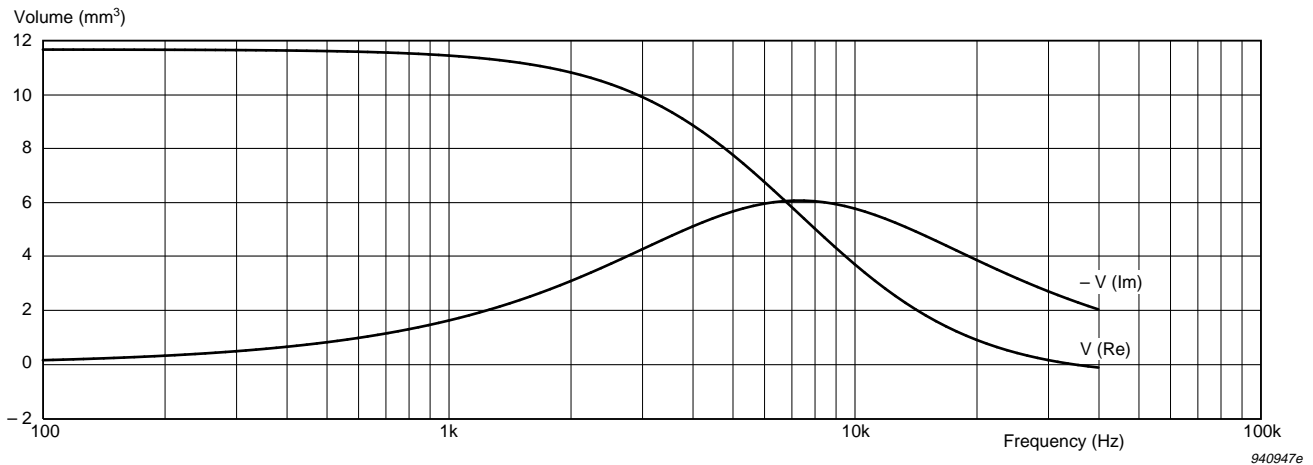

Fig 5.18 Typical equivalent volume (real and imaginary parts) based on mathematical model of microphone

Model 1

$$C = 0.082 \times 10^{-12} \text{ m}^5/\text{N}$$

$$L = 253 \text{ kg/m}^4$$

$$R = 278 \times 10^6 \text{ Ns/m}^5$$

where C = acoustic diaphragm compliance
 L = acoustic diaphragm mass
 R = acoustic diaphragm damping resistance

Model 2

$$V_{lf} = 11.6 \text{ mm}^3$$

$$f_0 = 35 \text{ kHz}$$

$$Q = 0.2$$

where V_{lf} = low-frequency volume
 f_0 = diaphragm resonance frequency
 Q = quality factor

Calibrator Load Volume

When the microphone with its protection grid is inserted into the coupler of a calibrator, it will load the calibrator by a volume of 190 mm^3 at 250 Hz.

Load volume correction to Pistonphone Type 4228 Calibration Level (with Adaptor DP 0776): +0.02 dB

5.7 Capacitance

The microphone's impedance is determined by its polarized capacitance. In addition, the preamplifier's input resistance and capacitance load the microphone. This loading determines the electrical lower limiting frequency and the capacitive input attenuation. However, with modern preamplifiers, this loading is very small and is included in the preamplifier gain, G (see [section 5.2.2](#)). Only in special cases with high capacitive loading does the fall in capacitance with frequency have to be taken into account.

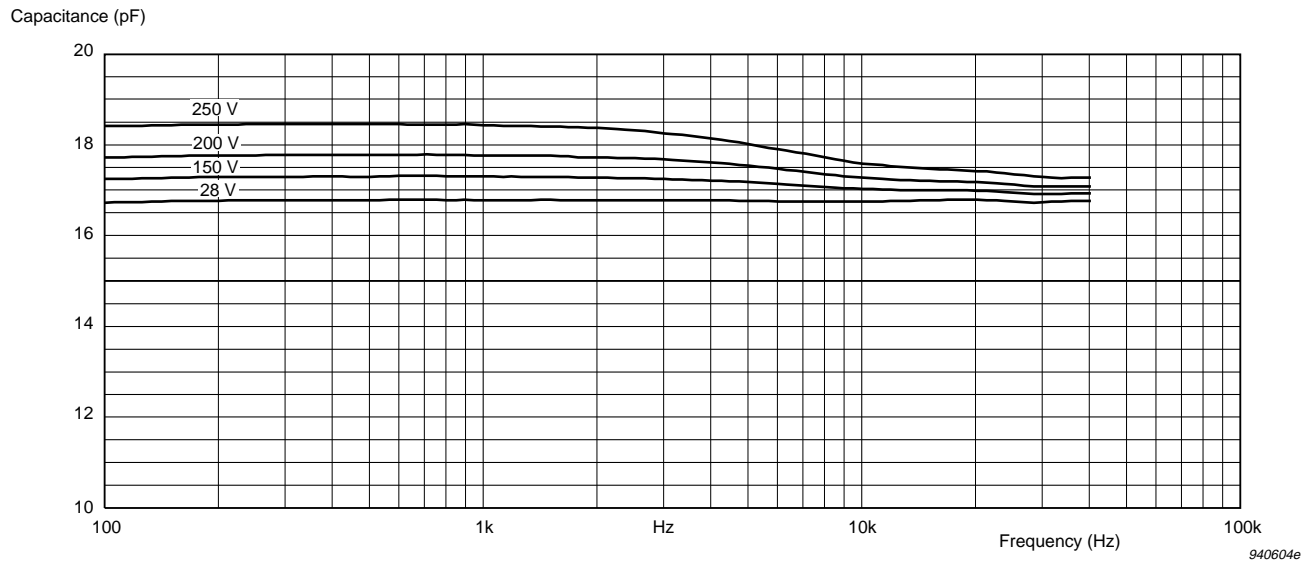

Fig. 5.19 Variation of capacitance with polarization voltage and frequency

Typical capacitance (at 250 Hz): 18 pF.

The capacitance is individually calibrated and stated on the calibration chart.

5.8 Polarization Voltage

Generally, a microphone is operated at its nominal polarization voltage. For Free-field $\frac{1}{2}$ " Microphone Type 4191, this is 200 V. As this polarization voltage is positive, the output voltage is negative for a positive pressure applied to the diaphragm.

In special cases where there is a risk of preamplifier overload or there are long cables to be driven, choose a lower voltage. This will cause a lower sensitivity (see [Fig. 5.20](#)) and a change in the frequency response (see [Fig. 5.21](#)).

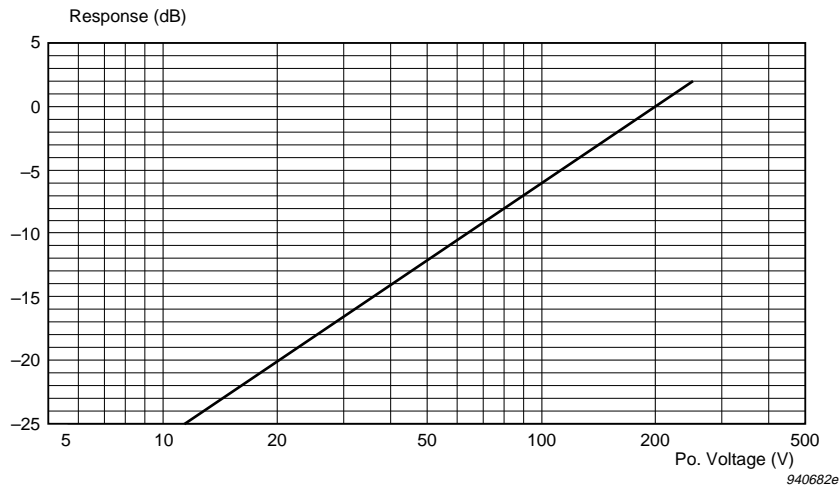

Fig. 5.20 Variation in sensitivity (at 250 Hz) as a function of polarization voltage, relative to the sensitivity with a polarization voltage of 200 V

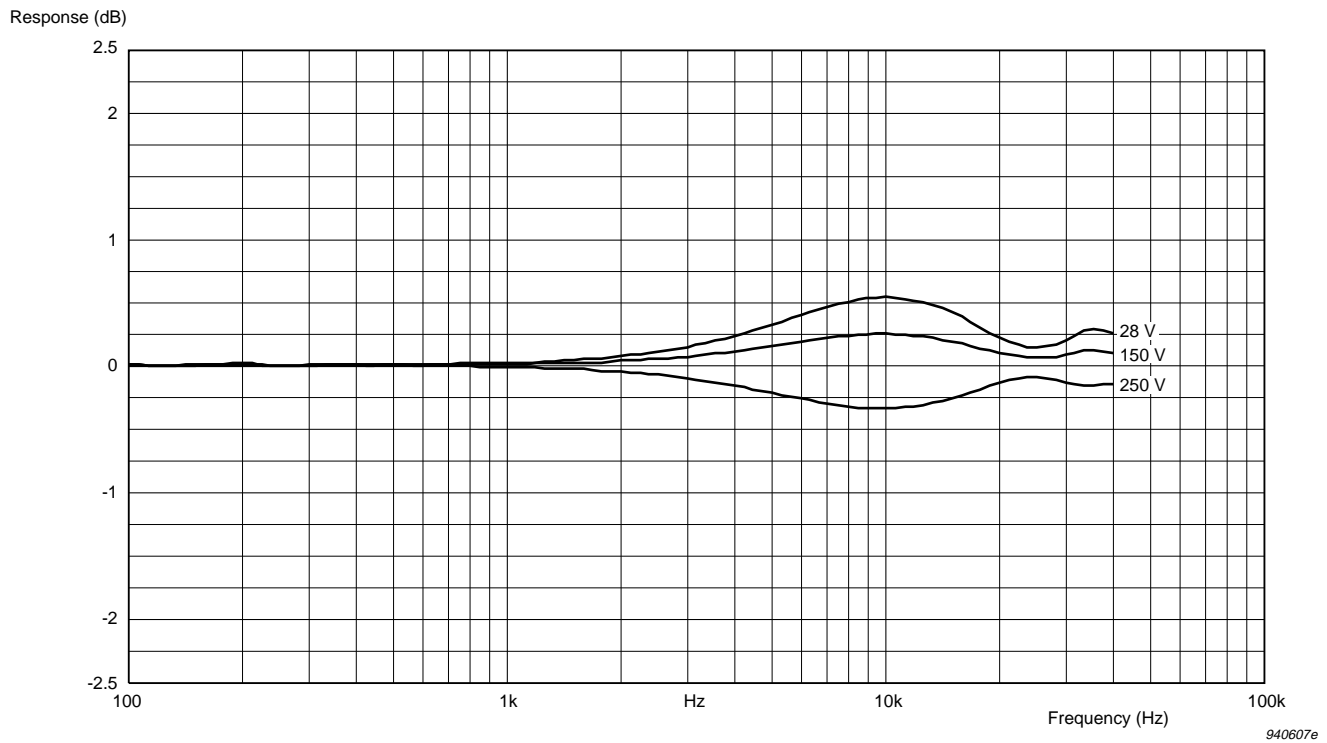

Fig. 5.21 Effect of polarization voltage on frequency response. The curves show the difference from the response with a polarization voltage of 200 V (normalised at 250 Hz)

5.9 Leakage Resistance

To maintain the correct polarization voltage on the microphone, the microphone's leakage resistance must be at least 1000 times greater than the supply resistance of the polarization charge, even under the most severe environmental conditions. This resistance which is generally placed in the preamplifier, is typically 10^9 to $10^{10} \Omega$. Brüel & Kjær microphones have a very high leakage resistance which is greater than $5 \times 10^{15} \Omega$ at 90%RH and 23°C.

5.10 Stability

5.10.1 Mechanical Stability

The microphone's design with respect to mechanical stability is improved compared with traditional Brüel & Kjær microphones. The diaphragm clamping ring is less sensitive to accidental force and the protection grid is significantly reinforced. Therefore, the microphone can withstand mechanical shocks better than traditional Brüel & Kjær microphones.

The sensitivity change of the microphone is less than 0.1 dB after a free fall of 1 m onto a solid hardwood block (re IEC 68-2-32).

This improved mechanical stability makes Free-field $\frac{1}{2}$ " Microphone Type 4191 well-suited for surface mounting and for mounting in small couplers as no mechanical adaptor is required to protect the diaphragm clamping ring. The microphone can be supported by the diaphragm clamping ring directly on the coupler's surface. Any force of less than 5 Newtons will cause a change in sensitivity of less than 0.005 dB. This makes the microphone well-suited for fitting in small, plane wave couplers used for reciprocity calibration and any other small coupler with a well-defined volume.

5.10.2 High-temperature Stability

The diaphragm is made of a stainless steel alloy. The alloy has been carefully selected and is very resistant to heat. This means that the diaphragm tension (and therefore the sensitivity) remain the same, even after several hours' operation at high temperature.

The microphone has been tested at temperatures up to 300°C. Below 170°C, no changes occur. At 170°C, the sensitivity can be permanently changed within the first 10 hours by less than 0.025 dB. After this, the sensitivity can be permanently changed within the next 100 hours by a similar value. At 300°C, the sensitivity can be permanently changed within the first hour by +0.4 dB. After this, the sensitivity can be permanently changed within the next 10 hours by less than +0.4 dB.

Note: Special adaptors (inserted between the microphone and preamplifier) must be made for high-temperature applications in order to protect the preamplifier from heat conduction and radiation.

5.10.3 Long-term Stability

Over a period of time, the mechanical tension in the diaphragm will decrease due to stretching within the foil. This mechanism, which, in principle, causes an increased sensitivity, is, however, very weak for the microphone. Measurement of this mechanism is not possible at room temperature.

At present, no exact value can be given for the microphone's long-term stability but measured changes at high temperatures indicate that Free-field $\frac{1}{2}$ " Microphone Type 4191 is more than 10 times more stable than traditional Brüel & Kjær microphones. This indicates typical changes of less than 1 dB in 5000 years.

5.11 Effect of Temperature

By careful selection of materials, optimization of the design and artificial ageing, the effect of temperature has been made to be very low.

The microphone has been designed to operate at temperatures from -30 to 300°C . When the microphone is subjected to temperatures above 200°C , it may be discoloured but its functionality will remain unaffected. See [section 5.10.2](#) for permanent changes in sensitivity at temperatures above 170°C .

The reversible changes are shown in Fig.5.22 as a change in sensitivity and in Fig.5.23 to Fig.5.25 as changes in the frequency response normalized at 250 Hz.

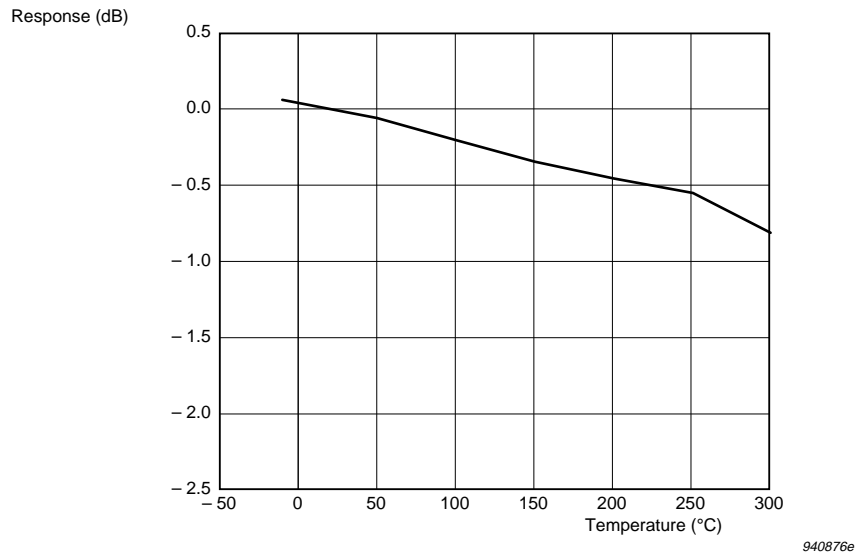

Fig. 5.22 Typical variation in sensitivity (at 250 Hz) as a function of temperature, relative to the sensitivity at 20°C

Temperature Coefficient (250 Hz):

-0.002 dB/°C, typical (for the range -10 to +50°C)

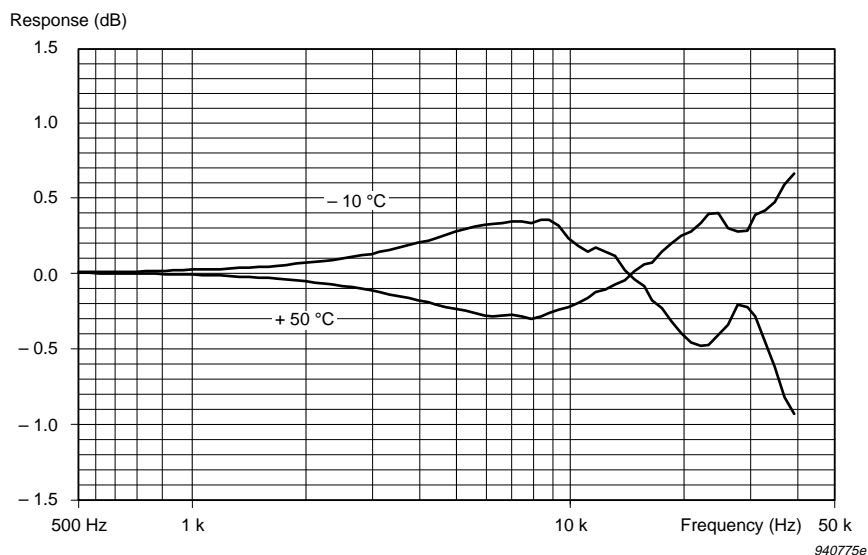

Fig.5.23 Typical variation in actuator response (normalized at 250 Hz) as a function of temperature, relative to the response at 20°C (see Fig.5.4) over the temperature range defined by IEC 651

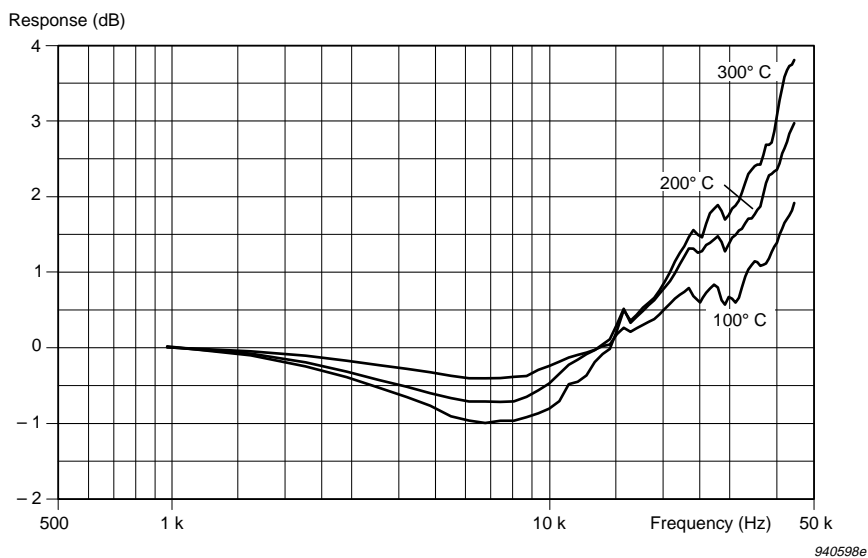

Fig.5.24 Typical variation in actuator response (normalized at 250 Hz) as a function of temperature, relative to the response at 20°C (see Fig.5.4)

The effect of temperature on the free-field response (see Fig. 5.25) of the microphone is the sum of the following effects:

- the calculated effect of the change in the speed of sound due to temperature on the 0° -incidence free-field correction
- the measured change in the actuator response due to temperature (see Fig. 5.23).

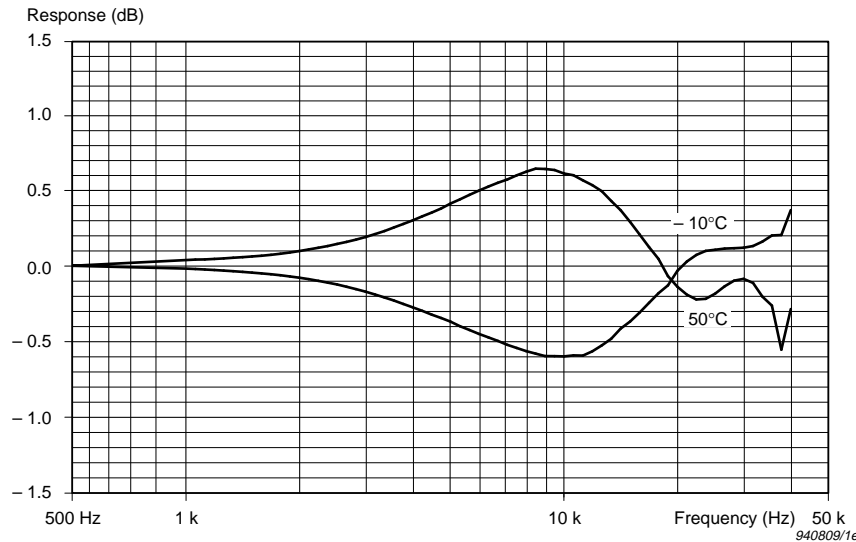

Fig. 5.25 Typical variation in 0° -incidence free-field response with Protection Grid DB 3421 (normalized at 250 Hz) as a function of temperature, relative to the response at 20°C (see Fig. 5.7) over the temperature range defined by IEC 651

5.12 Effect of Ambient Pressure

The microphone's sensitivity and frequency response are affected by variations in the ambient pressure. This is due to changes in air stiffness in the cavity behind the diaphragm, and changes in air mass in the small gap between the diaphragm and the back plate. The effects are shown in Fig. 5.26 to Fig. 5.28.

The typical pressure coefficient at 250 Hz for Free-field 1/2" Microphone Type 4191 is -0.007 dB/kPa, well within the ± 0.03 dB/kPa limits required for Type 0 and Type 1 sound level meters by IEC 651.

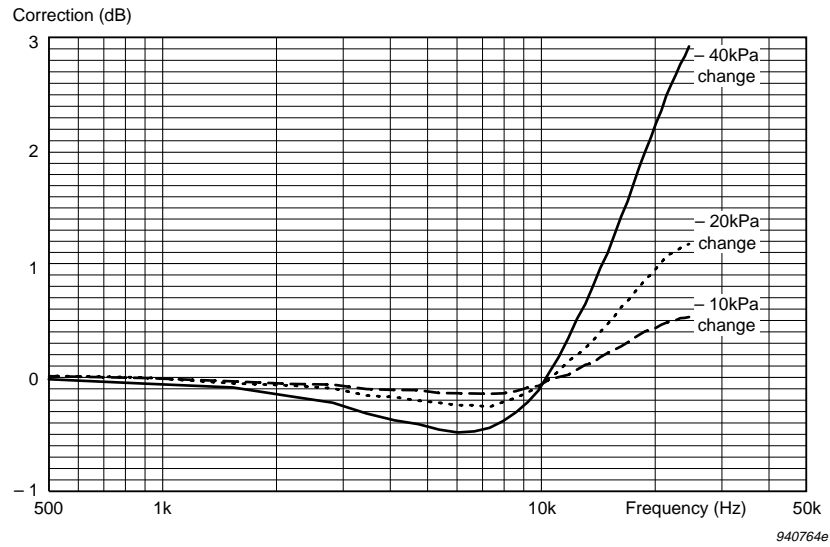

Fig.5.26 Typical variation in frequency response (normalized at 250 Hz) from that at 101.3 kPa as a function of change in ambient pressure

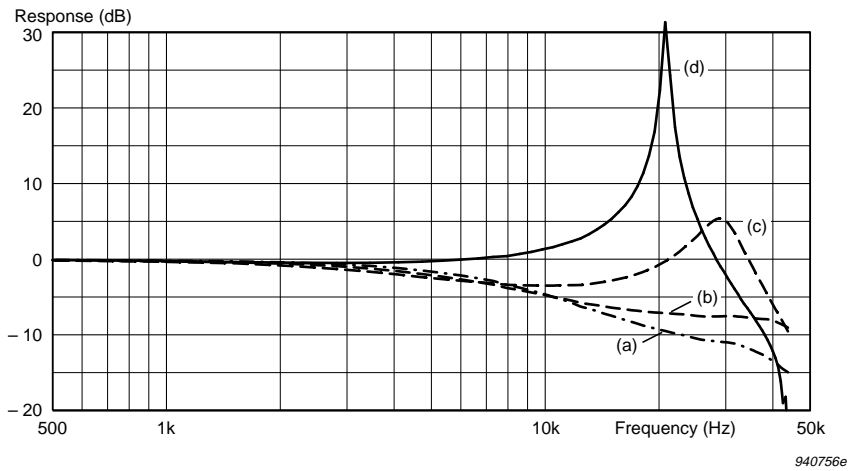

Fig.5.27 Typical effect of ambient pressure on actuator response (a) at 101.3 kPa (b) -40kPa change (c) -80kPa change (d) at 2 kPa

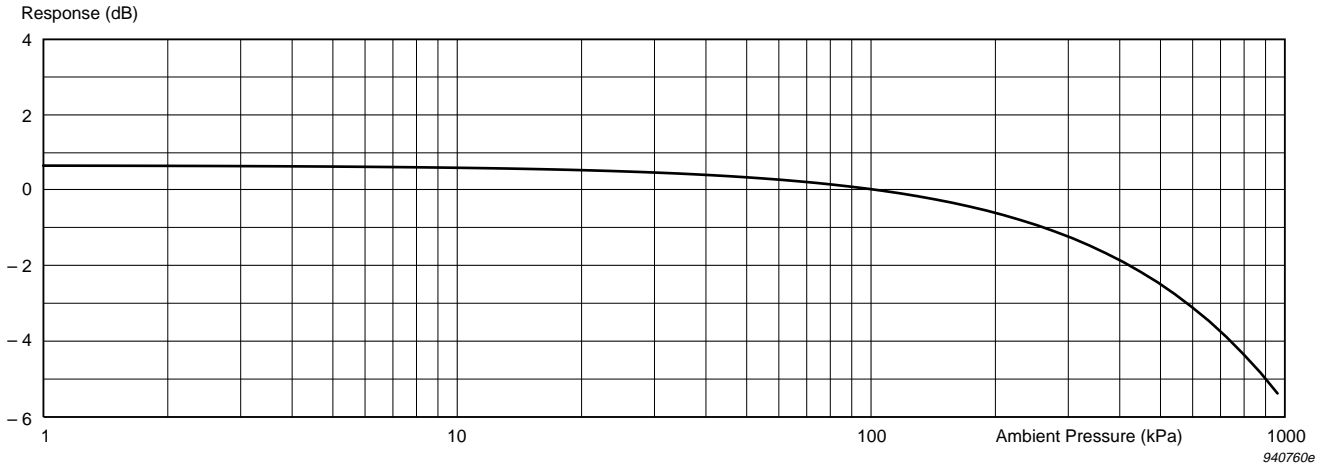

Fig. 5.28 Typical variation in sensitivity at 250 Hz from that at 101.3 kPa as a function of ambient pressure

5.13 Effect of Humidity

Due to the microphone's high leakage resistance, humidity has, in general, no effect on the microphone's sensitivity or frequency response. The microphone has been tested according to IEC 68-2-3 and the effects of humidity on the sensitivity at 250 Hz and the frequency response have been found to be less than 0.1 dB at up to 95% RH (non-condensing) and 40°C.

5.14 Effect of Vibration

The effect of vibration is determined mainly by the mass of the diaphragm and is at its maximum for vibrations applied normal to the diaphragm. A vibration signal of 1 m/s^2 RMS normal to the diaphragm typically produces an equivalent Sound Pressure Level of 65.5 dB for a microphone fitted with Protection Grid DB 3421.

5.15 Effect of Magnetic Field

The effect of a magnetic field is determined by the vector field strength and is normally at its maximum when the field direction is normal to the diaphragm. A magnetic field strength of 80 A/m at 50 Hz (the test level recommended by IEC and ANSI) normal to the diaphragm produces a typical equivalent Sound Pressure Level of 16 dB. Higher frequency components in the microphone output become dominant at field strengths greater than 500 to 1000 A/m.

5.16 Electromagnetic Compatibility

See [Chapter 8](#).

5.17 Specifications Overview

<p>OPEN-CIRCUIT SENSITIVITY (250 Hz)*: -38 dB ±1.5 dB re 1 V/Pa, 12.5 mV/Pa*</p> <p>POLARIZATION VOLTAGE: External: 200 V</p> <p>FREQUENCY RESPONSE*: 0° incidence free-field response: 5 Hz to 16 kHz ±1 dB 3.15 Hz to 40 kHz ±2 dB In accordance with IEC 651, Type 0, Type 1 and ANSI S1.12, Type M</p> <p>LOWER LIMITING FREQUENCY (-3 dB): 1 Hz to 2 Hz (vent exposed to sound)</p> <p>PRESSURE EQUALIZATION VENT: Side vented</p> <p>DIAPHRAGM RESONANCE FREQUENCY: 34 kHz, typical (90° phase shift)</p> <p>CAPACITANCE (POLARIZED)*: 18 pF, typical (at 250 Hz)</p> <p>EQUIVALENT AIR VOLUME (101.3 kPa): 11.6 mm³</p> <p>_____</p> <p>* Individually calibrated</p>	<p>CALIBRATOR LOAD VOLUME (250 Hz): 190 mm³</p> <p>PISTONPHONE TYPE 4228 CORRECTION: with DP 0776: +0.02 dB</p> <p>TYPICAL CARTRIDGE THERMAL NOISE: 20.0 dB (A) 21.4 dB (Lin.)</p> <p>UPPER LIMIT OF DYNAMIC RANGE: 3% distortion: >162 dB SPL</p> <p>MAXIMUM SOUND PRESSURE LEVEL: 171 dB (peak)</p> <p>OPERATING TEMPERATURE RANGE: -30 to +150°C (-22 to 302°F) can be used up to +300°C (572°F) but with a permanent sensitivity change of typically +0.4 dB which stabilises after one hour</p> <p>OPERATING HUMIDITY RANGE: 0 to 100% RH (without condensation)</p> <p>STORAGE TEMPERATURE: -30 to +70°C (-22 to 158°F)</p> <p>TEMPERATURE COEFFICIENT (250 Hz): -0.002 dB/°C, typical (for the range -10 to +50°C)</p>	<p>PRESSURE COEFFICIENT (250 Hz): -0.007 dB/kPa, typical</p> <p>INFLUENCE OF HUMIDITY: <0.1 dB/100%RH</p> <p>VIBRATION SENSITIVITY (<1000 Hz): Typically 65.5 dB equivalent SPL for 1 m/s² axial acceleration</p> <p>MAGNETIC FIELD SENSITIVITY: Typically 16 dB SPL for 80 A/m, 50 Hz field</p> <p>ESTIMATED LONG-TERM STABILITY: >1 000 years/dB at 20°C >1 00 hours/dB at 150°C</p> <p>DIMENSIONS: Diameter: 13.2 mm (0.52 in) (with grid) 12.7 mm (0.50 in) (without grid) Height: 13.5 mm (0.54 in) (with grid) 12.6 mm (0.50 in) (without grid) Thread for preamplifier mounting: 11.7 mm – 60 UNS</p> <p>The data above are valid at 23°C, 101.3 kPa and 50%RH, unless otherwise specified.</p>
--	---	---

5.18 Ordering Information

Preamplifier

Type 2669: 1/2" Microphone Preamplifier

Calibration Equipment

Type 4231: Sound Level Calibrator

Type 4226: Multifunction Acoustic Calibrator

Type 4228: Pistonphone

UA 0033: Electrostatic Actuator

Other Accessories

UA 0254: Set of 6 Windscreens (UA 0237) 90 mm (3.5 in)

UA 0469: Set of 6 Windscreens (UA 0459) 65 mm (2.6 in)

Chapter 6

Pressure-field 1/2" Microphone Type 4192

6.1 Introduction

6.1.1 Description



Fig. 6.1 Pressure-field $\frac{1}{2}$ " Microphone Type 4192 with Protection Grid DB 3421 (included)

Pressure-field $\frac{1}{2}$ " Microphone Type 4192 is an externally-polarized $\frac{1}{2}$ " pressure-field microphone for sound measurements requiring random-incidence response in accordance with the requirements of ANSI S1.4 Type 1 or for coupler measurements, for example, in connection with telephone and hearing aid testing. Furthermore, it also satisfies the requirements of ANSI S 1.12 Type M. With its low inherent noise and frequency range from 3.15 Hz to 20 kHz, it is very well suited for a wide range of precision audio-frequency sound measurements.

The microphone requires a polarization voltage of 200 V, provided by the instrument or analyzer powering the associated preamplifier.

This rugged microphone is built to ensure high stability under a variety of conditions. For example, the stainless steel alloy diaphragm withstands polluted industrial environments. The diaphragm clamping ring is firmly secured to ensure the microphone's reliability, even when the microphone is used without its protection grid. When the microphone is used without its protection grid, it can be easily flush-mounted or inserted into closed volumes as it can be supported by the diaphragm clamping ring, provided that a force of less than 5 Newtons is applied.

The microphone is supplied with individual calibration data on a calibration chart and on a $3\frac{1}{2}$ " data disk in a case. This case can also contain a $\frac{1}{2}$ " Microphone Preamplifier Type 2669.

6.1.2 The Calibration Chart

Each microphone is supplied with an individual calibration chart (see Fig. 6.2) which gives the microphone's open-circuit sensitivity, polarized capacitance and pressure-field and random-incidence frequency responses.

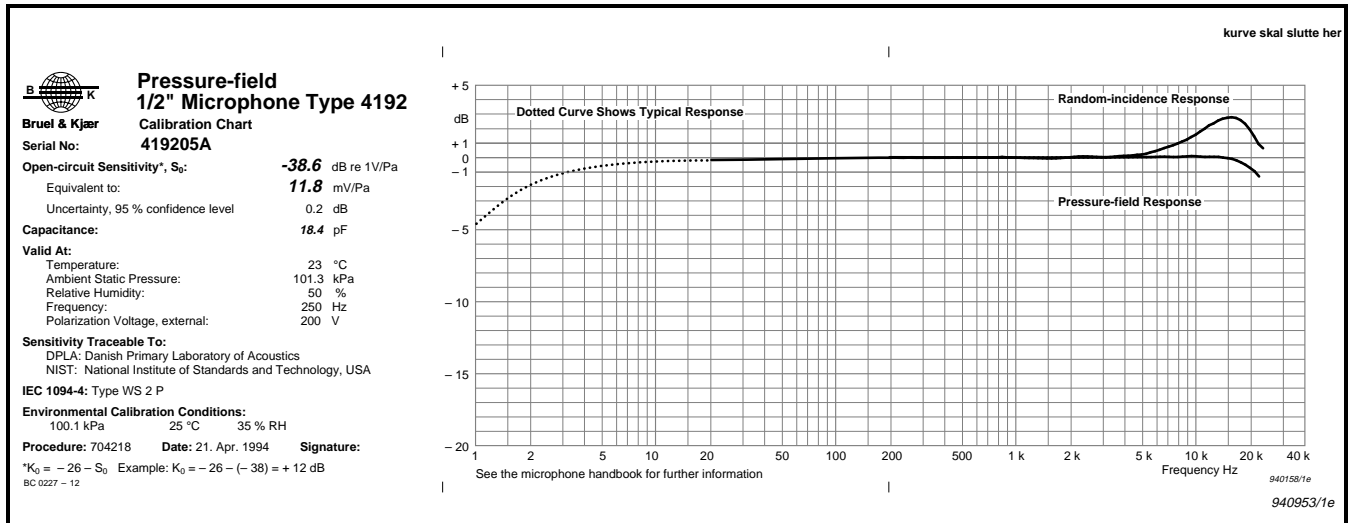

Fig. 6.2 Microphone calibration chart

Open-circuit Sensitivity

The stated open-circuit sensitivity is valid at the reference frequency (251.2 Hz^{*}) for free-field, random-incidence and pressure-field conditions. The stated uncertainty is the U_{95} value (the value valid for 95% confidence level).

Ambient Conditions

The ambient conditions are measured continuously during calibration at the factory. The calibration results obtained at the measured Environmental Calibration Conditions are corrected to the reference ambient conditions stated under Valid At (23°C, 101.325 kPa and 50% RH).

Frequency Responses

Two frequency responses are shown on the calibration chart. Both are normalized to 0 dB at the reference frequency (251.2 Hz^{*}).

*The exact reference frequency is 10^{2.4} Hz (re ISO 266).

The lower curve on the calibration chart is the individual microphone's open-circuit pressure-field response. This response is the optimized response for the Pressure-field $\frac{1}{2}$ " Microphone Type 4192.

The upper curve on the calibration chart is the random-incidence response.

Both curves are determined by adding the relevant correction curve to the individual actuator response measured with Electrostatic Actuator UA 0033. The individual microphone's electrostatic actuator response is also available on the data disk.

The dotted part of the curve is the typical low-frequency response. Each microphone's individual lower limiting frequency is measured to ensure that it is within the specified tolerances (see Fig. 6.3).

6.1.3 Data Disk

The $3\frac{1}{2}$ " data disk supplied with each microphone supplements the calibration chart. It contains individual calibration data and correction curves (see Table 6.1) with a frequency resolution of $\frac{1}{12}$ -octave as comma-separated ASCII text files under the \DATA directory.

File Name	Content	Frequency Range
S#####.BKM ^a	Sensitivity calibration	251.2 Hz
A#####.BKM ^a	Actuator response	200 Hz – 22 kHz
P#####.BKR ^b	Pressure-field response	1 Hz – 22 kHz
4192L.BKT ^c	Low-frequency response	1 Hz – 190 Hz
4192F.BKC ^d	Free-field corrections without protection grid	200 Hz – 22 kHz
4192FG.BKC ^d	Free-field corrections with protection grid	200 Hz – 22 kHz
4192R.BKC ^d	Random-incidence corrections without protection grid	200 Hz – 22 kHz
4192RG.BKC ^d	Random-incidence corrections with protection grid	200 Hz – 22 kHz
4192P.BKC ^d	Pressure-field corrections	200 Hz – 22 kHz

Table 6.1 Calibration data and corrections contained on the data disk. Note: ##### is the microphone's serial number

a. Individual calibration data (measured).

b. Low-frequency response combined with actuator response and free-field corrections.

c. Typical response for Pressure-field $\frac{1}{2}$ " Microphone Type 4192.

d. Corrections for Pressure-field $\frac{1}{2}$ " Microphone Type 4192.

These text files can be viewed on Microsoft® Windows™ using the Brüel & Kjær Microphone Viewer program (BK-MIC.EXE) supplied on the disk. They can also be accessed by a suitable spreadsheet for further processing or printing.

Brüel & Kjær Microphone Viewer must be installed before use (see [section 1.3.5](#)).

6.1.4 Recommended Recalibration Interval

With normal handling of the microphone and any associated instrument, Brüel & Kjær recommends that the microphone be recalibrated every 2 years.

Pressure-field 1/2" Microphone Type 4192 is very stable over this period (see [section 6.10](#) to [section 6.12](#)). Improper handling is by far the most likely cause of change in the microphone's properties. Any damage which causes improper operation can probably be detected using a sound level calibrator. In many cases, the damage can be seen by carefully inspecting the protection grid and diaphragm.

6.2 Sensitivity

6.2.1 Open-circuit Sensitivity

The open-circuit sensitivity is defined as the sensitivity of the microphone when not loaded by the input impedance of the connected preamplifier (the termination is described in IEC 1094–2). The sensitivity is measured for the individual microphone at 251.2 Hz and stated on the microphone's calibration chart (see [section 6.1.2](#)) and data disk (see [section 6.1.3](#)). The nominal sensitivity is shown in [Table 6.2](#).

Nominal open-circuit sensitivity		Accepted Deviation (dB)
mV/Pa	dB re 1 V/Pa	
12.5	–38	±1.5

Table 6.2 Nominal open-circuit sensitivity

6.2.2 Loaded Sensitivity

When loaded by a preamplifier, the sensitivity of the microphone is given by:

$$S_C = S_O + G \quad (6.1)$$

where S_C = overall sensitivity of microphone and preamplifier combination
 S_O = open-circuit sensitivity of microphone
 G = voltage gain of microphone and preamplifier combination (in dB)

With Microphone Preamplifier Type 2639: $G = -0.1$ dB

With 1/2" Microphone Preamplifier Type 2669: $G = -0.2$ dB

Example

Loaded sensitivity of typical microphone with 1/2" Microphone Preamplifier Type 2669:

$$S_C = -38.3 + (-0.2) = -38.5 \text{ dB}$$

6.2.3 K-factor

Some types of Brüel & Kjær instruments use the K-factor (correction factor) or the K_O -factor (open-circuit correction factor) for calibration.

$$K = -26 - S_C \quad (6.2)$$

$$K_O = -26 - S_O \quad (6.3)$$

Example

Correction factor for typical microphone with 1/2" Microphone Preamplifier Type 2669:

$$K = -26 - (-38.5) = +12.5 \text{ dB}$$

Open-circuit correction factor for typical microphone with 1/2" Microphone Preamplifier Type 2669:

$$K_O = -26 - (-38.3) = +12.3 \text{ dB}$$

6.3 Frequency Response

6.3.1 General

In acoustic measurements, there are three types of sound field:

- Free field
- Pressure field
- Diffuse field

The microphone is optimized to have a flat frequency response in one of these sound fields. This response is called the optimized response. A microphone's response in a diffuse field is equivalent to its random-incidence response.

This section shows the microphone's typical free-field, pressure-field and random-incidence responses together with the microphone's typical actuator response obtained using Electrostatic Actuator UA 0033. The low-frequency response described in [section 6.3.4](#) is common for all types of response.

All frequency responses and correction curves are shown with a frequency resolution of $\frac{1}{12}$ -octave.

6.3.2 Optimized Response (Pressure-field Response)

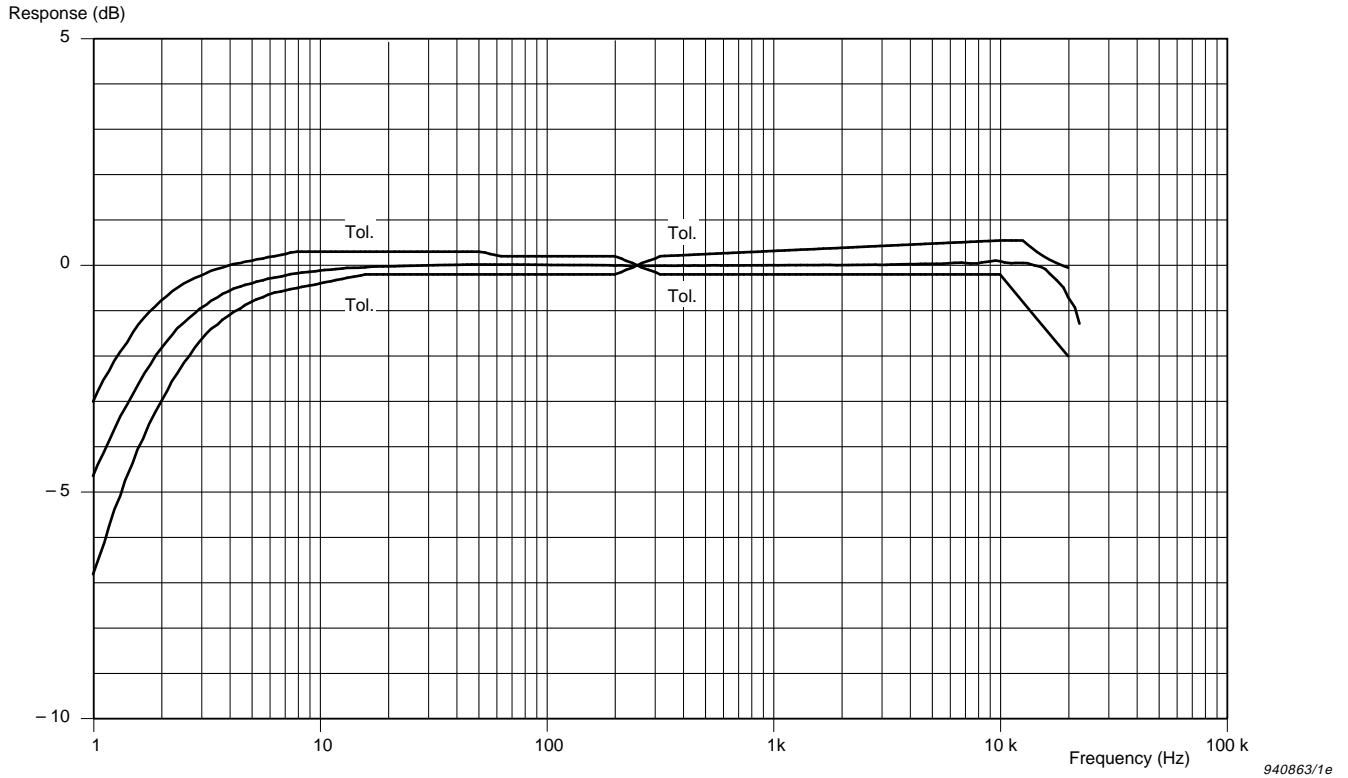

Fig. 6.3 Typical pressure-field response of the microphone with Protection Grid DB3421 and the microphone's specified tolerances. The low-frequency response is valid when the vent is exposed to the sound field

The frequency response of Pressure-field $\frac{1}{2}$ " Microphone Type 4192 meets the requirements of ANSI S1.4 -1983, Type 1 and ANSI S1.12, Type M.

6.3.3 Actuator Response

The microphone's frequency response is determined by adding corrections for the type of sound field to its actuator response obtained using Electrostatic Actuator UA 0033. This is a reproducible and practical method for calibrating a microphone's frequency response.

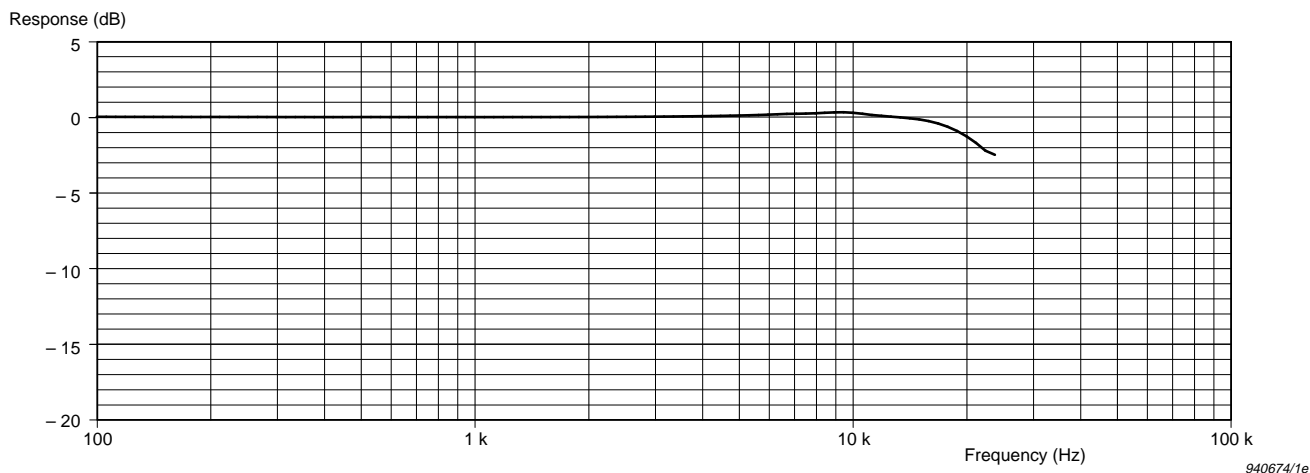

Fig. 6.4 Typical actuator response measured with Electrostatic Actuator UA 0033

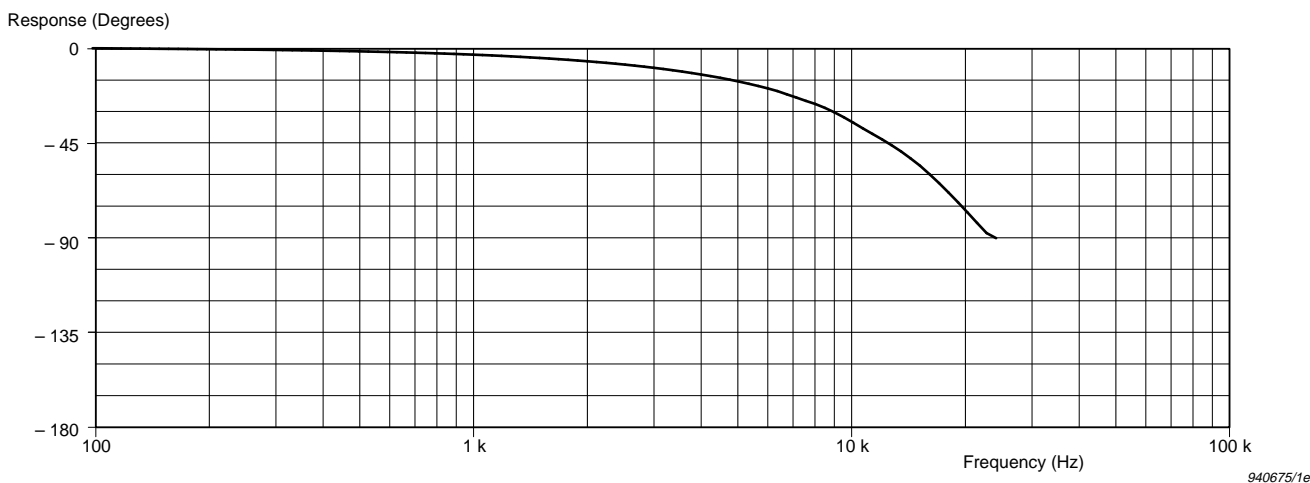

Fig. 6.5 Typical actuator phase response measured with Electrostatic Actuator UA 0033

If the polarization voltage is positive (as it is with Brüel & Kjær instruments), the output voltage is negative for a positive pressure applied to the diaphragm.

6.3.4 Low-frequency Response

The low-frequency response (see Fig. 6.3) is the typical response with the vent exposed to the sound field. If the vent is not exposed to the sound field, the sensitivity increases from 0 dB at the reference frequency (251.2 Hz) to approximately 0.2 dB at 1 Hz.

For applications where the vent is not exposed to the sound field, take care to ensure proper static pressure equalization to prevent static displacement of the diaphragm.

The microphone's low-frequency response is common for all types of sound field.

The microphone's lower limiting frequency (-3 dB) is between 1 and 2 Hz with the vent exposed to the sound field. This is measured during production to ensure that specifications are fulfilled.

6.3.5 Free-field Response

The microphone's free-field correction curves are shown in [Fig.6.6](#) and [Fig.6.8](#). These corrections are added to the microphone's actuator response obtained using Electrostatic Actuator UA 0033 in order to determine the free-field response at any angle of incidence. The typical free-field response at 0° incidence with and without the protection grid are shown in [Fig.6.7](#) and [Fig.6.9](#).

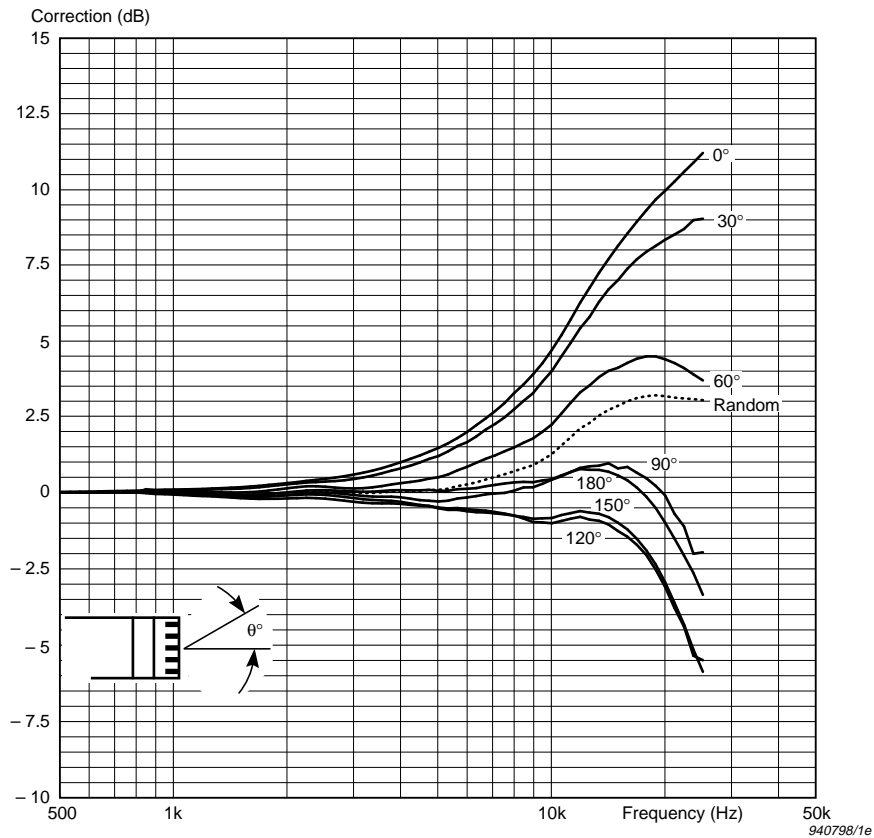

Fig. 6.6 Free-field correction curves for the microphone with Protection Grid DB 3421

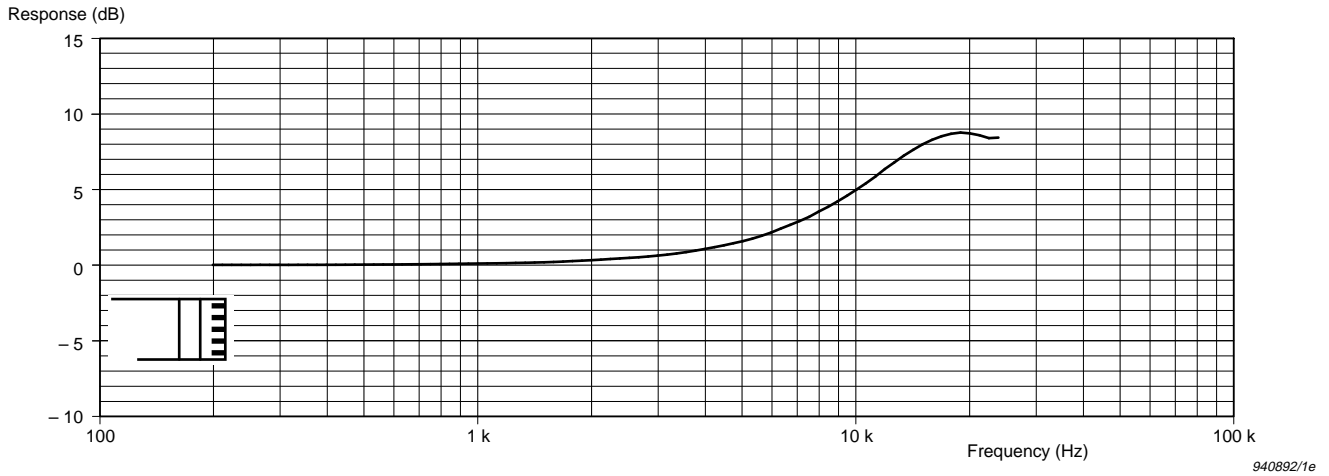

Fig 6.7 Typical free-field response (0° incidence) for the microphone with Protection Grid DB 3421

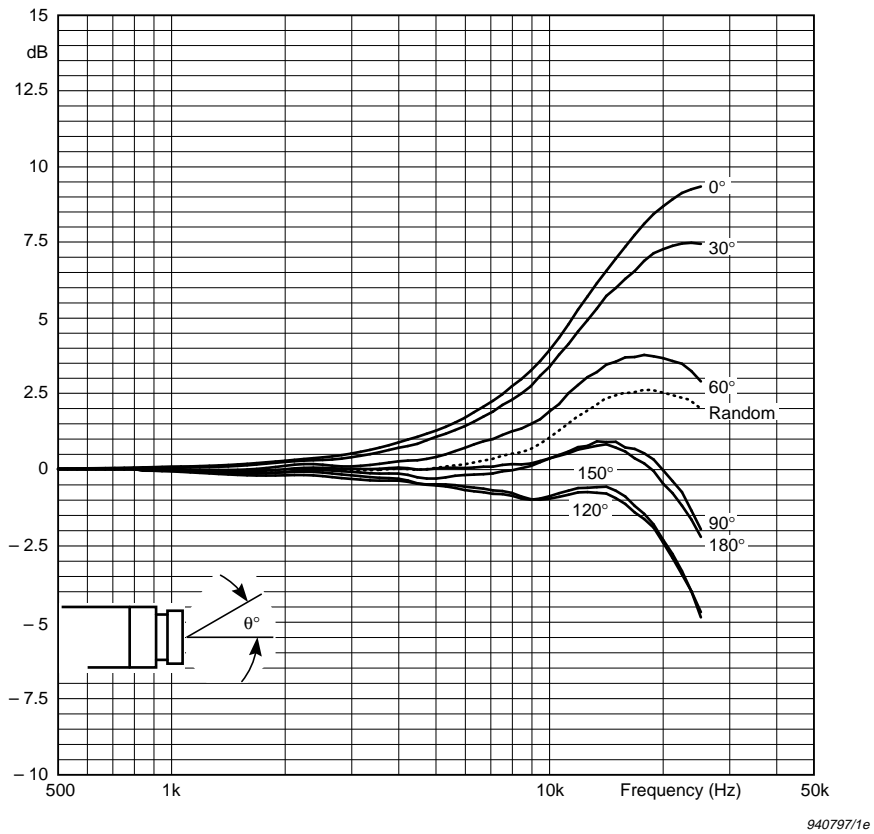

Fig 6.8 Free-field correction curves for the microphone without protection grid

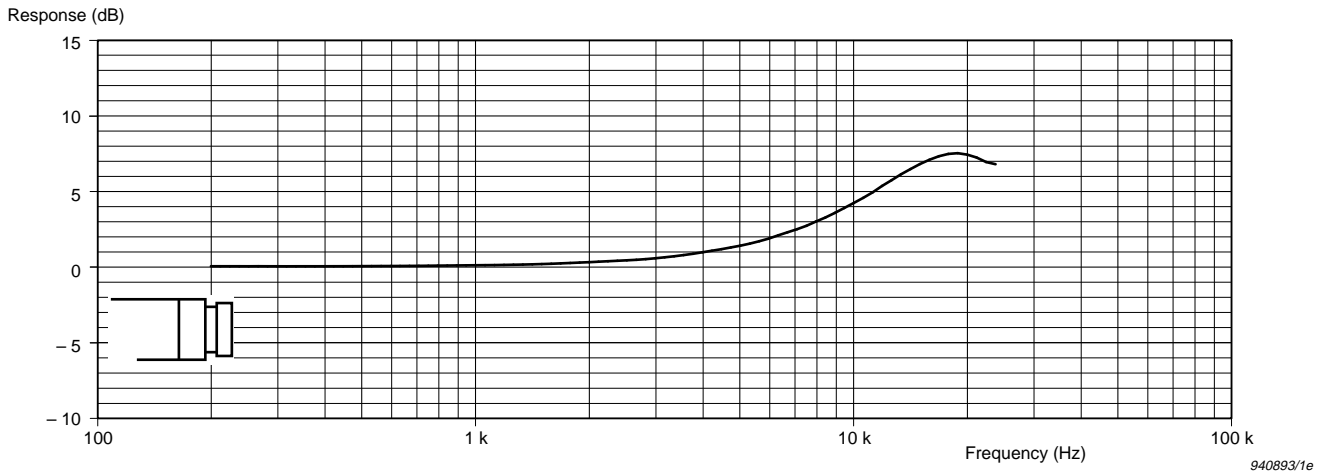

Fig. 6.9 Typical free-field response (0° incidence) for the microphone without protection grid

6.3.6 Random-incidence Response

A microphone's response in a diffuse sound field is equivalent to its random-incidence response. The microphone's random-incidence correction curves are shown in Fig. 6.6 and Fig. 6.8. These corrections are added to the microphone's actuator response obtained using Electrostatic Actuator UA 0033 in order to determine the random-incidence response. The typical random-incidence response with and without the protection grid are shown in Fig. 6.10 and Fig. 6.11.

The random-incidence corrections are calculated from the free-field corrections measured in 5° steps according to Draft IEC 1183–1993.

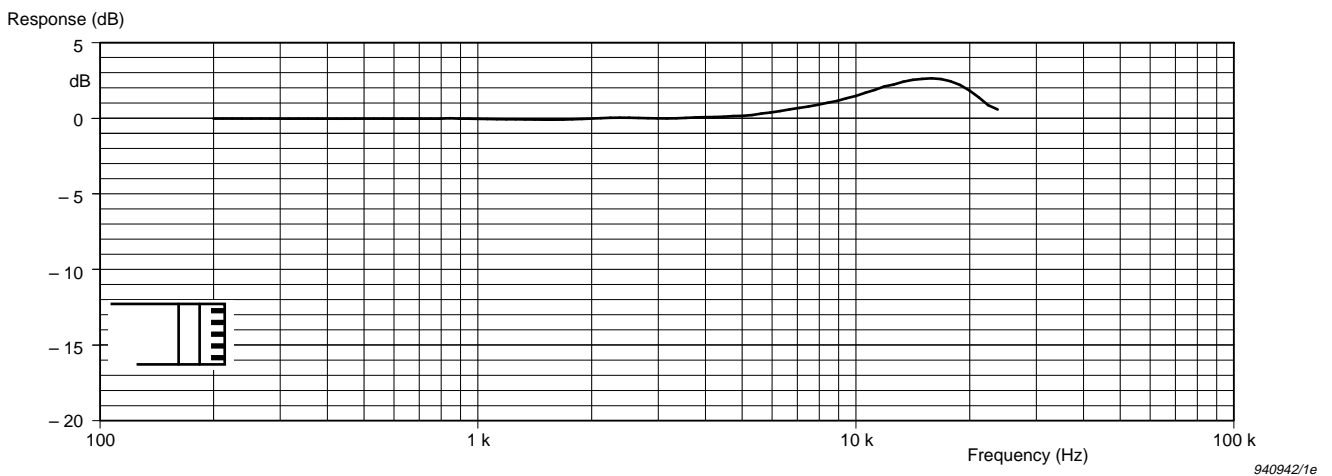

Fig. 6.10 Typical random-incidence response for the microphone with Protection Grid DB 3421

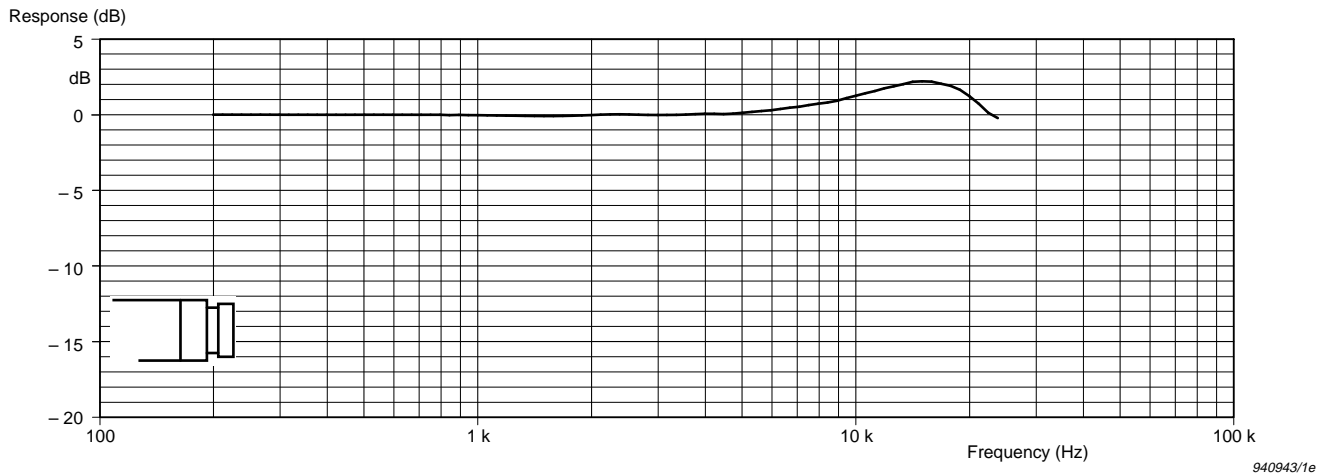

Fig. 6.11 Typical random-incidence response for the microphone without protection grid

6.3.7 Pressure-field Response

The microphone's pressure-field correction curve is shown in [Fig. 6.12](#). This correction is added to the microphone's actuator response obtained using Electrostatic Actuator UA 0033 in order to determine the pressure-field response. The typical pressure-field response is shown in [Fig. 6.13](#).

In practice, the pressure-field response is often regarded as being equal to the actuator response as the difference between them is small compared to the uncertainty related to many types of measurement.

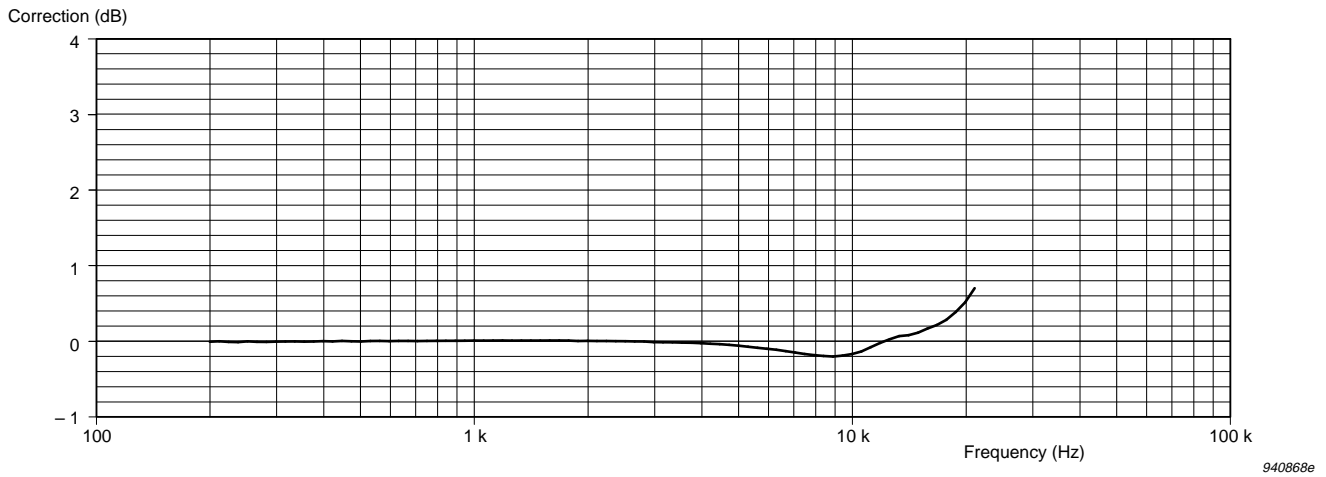

Fig. 6.12 Pressure-field correction for the microphone

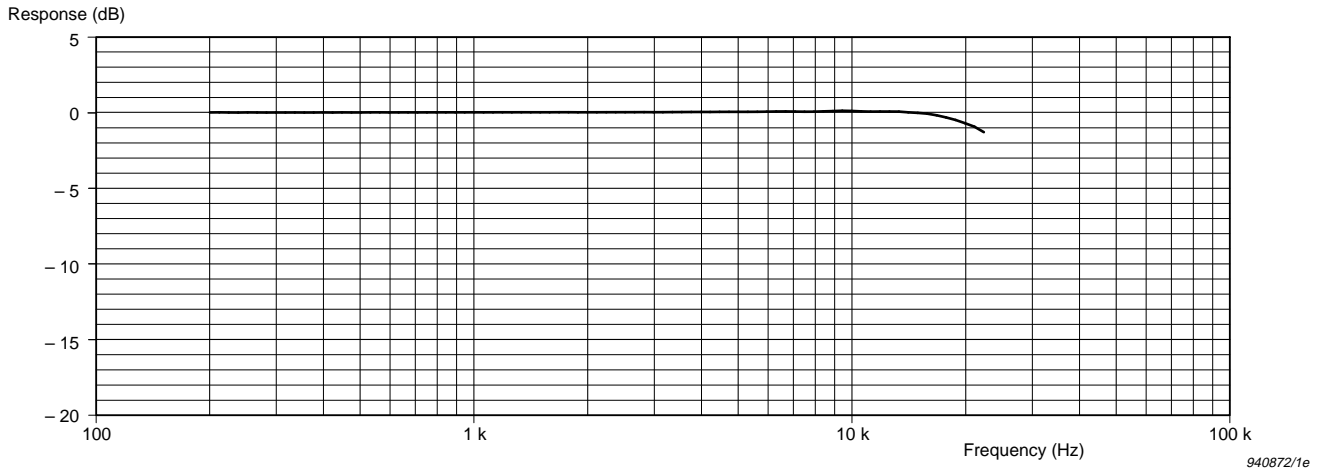

Fig. 6.13 Typical pressure-field response for the microphone

6.4 Directional Characteristics

Typical directional characteristics are given in [Fig. 6.14](#) and [Fig. 6.15](#). The characteristics are normalised relative to the 0° response.

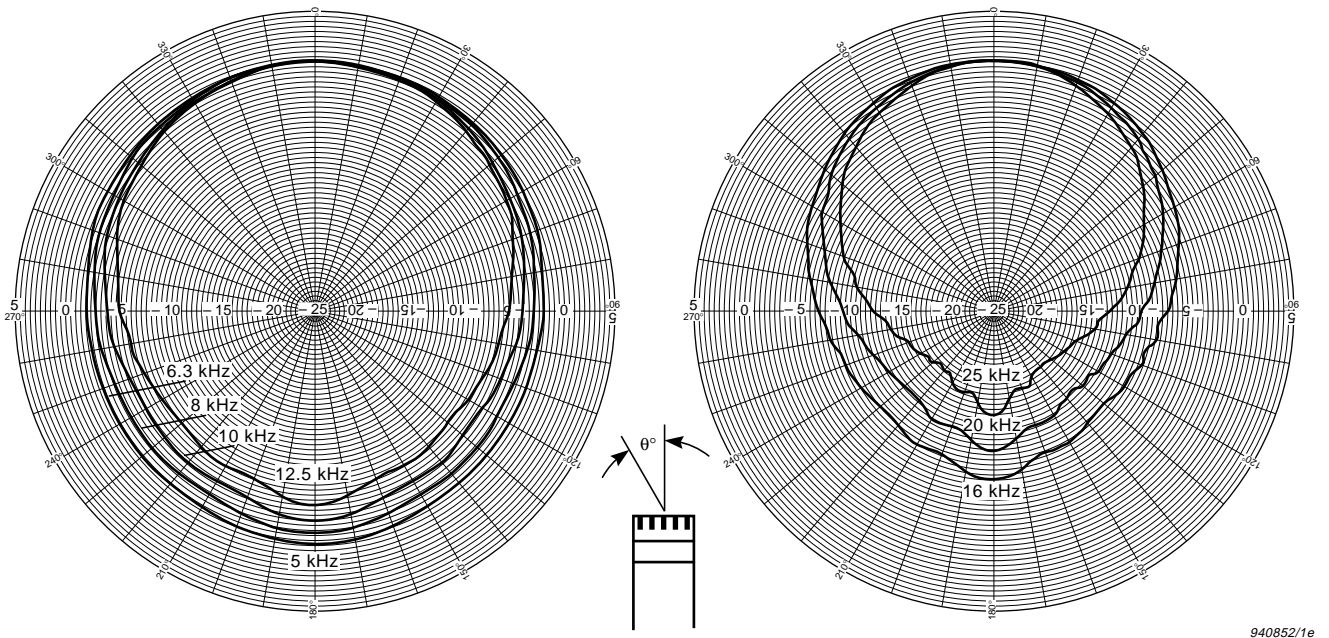
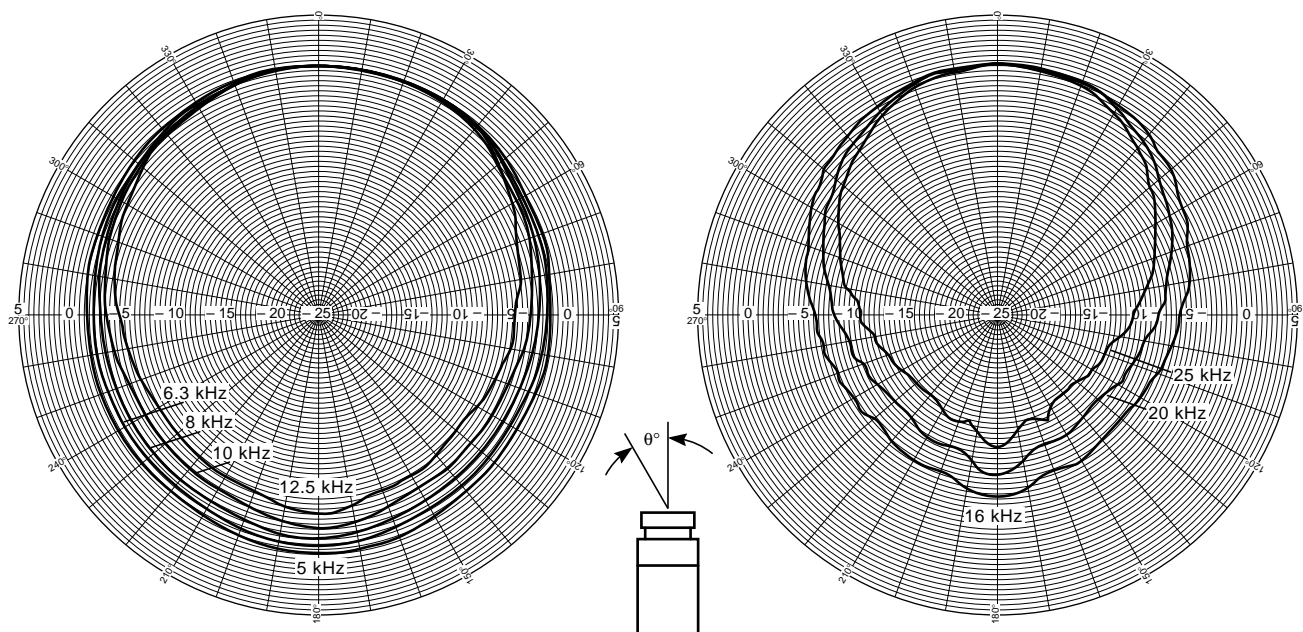

Fig. 6.14 Typical directional characteristics of the microphone with Protection Grid DB 3421



940853/1e

Fig. 6.15 Typical directional characteristics of the microphone without protection grid

6.5 Dynamic Range

Definition

The dynamic range is the range between the upper limit (determined by distortion) and the inherent noise floor. Both limits are influenced by the preamplifier. This section gives values for the microphone with and without a preamplifier.

Inherent Noise

The microphone's inherent noise is due to thermal movements of the diaphragm. These vary proportionally with the square root of the absolute temperature (in °K). The inherent noise increases with increasing temperature. With reference to 20 °C, the inherent noise changes by +0.5 dB at 55 °C and by -0.5 dB at -12 °C. The maximum variation of this noise for different samples of Pressure-field $\frac{1}{2}$ " Microphone Type 4192 is ± 1 dB.

The preamplifier's effect on the inherent noise of the combined microphone and preamplifier depends on the sensitivity and capacitance of the microphone (for 1/2" Microphone Preamplifier Type 2669, see Fig. 6.16 and [Chapter 8](#)).

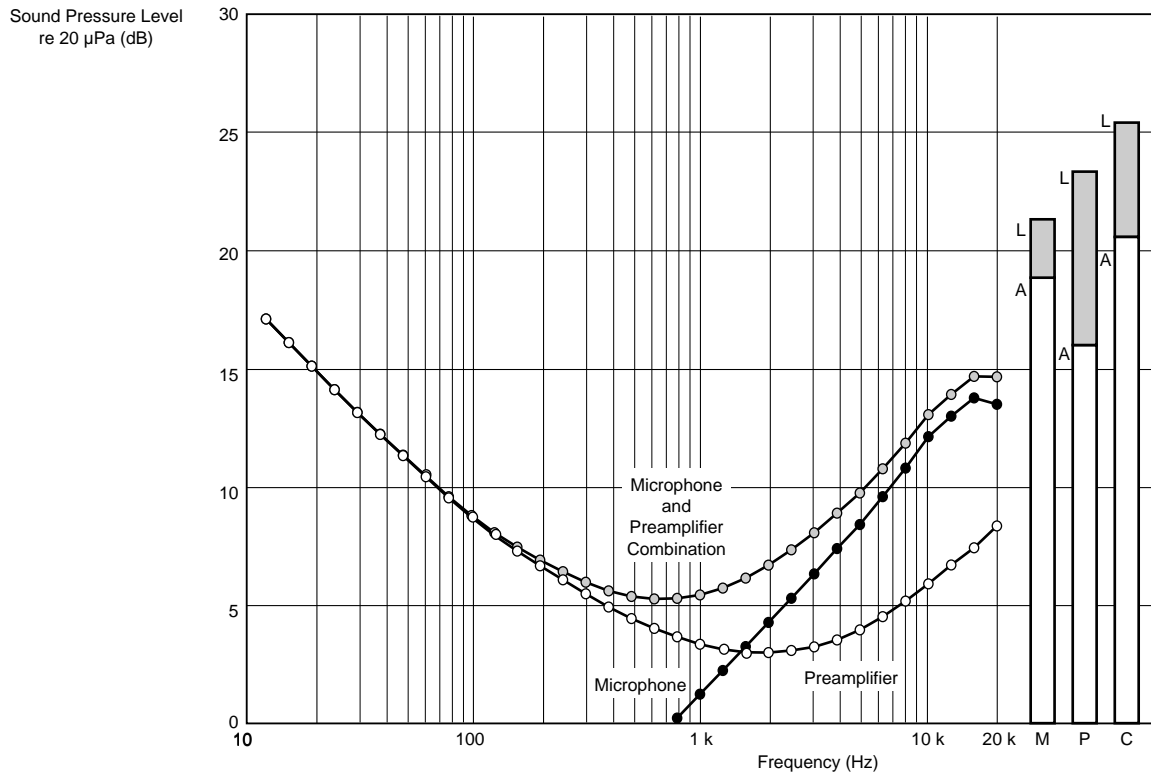

Fig. 6.16 1/3-octave-band inherent noise spectrum. The shaded bar graphs are the broad-band (20Hz to 20kHz) noise levels and the white bar graphs the A-weighted noise levels of the microphone (M), 1/2" Microphone Preamplifier Type 2669 (P) and microphone and preamplifier combination (C)

Distortion

The distortion is determined mainly by the microphone but, at the highest operation levels, the preamplifier also contributes to the distortion (see Fig. 6.17).

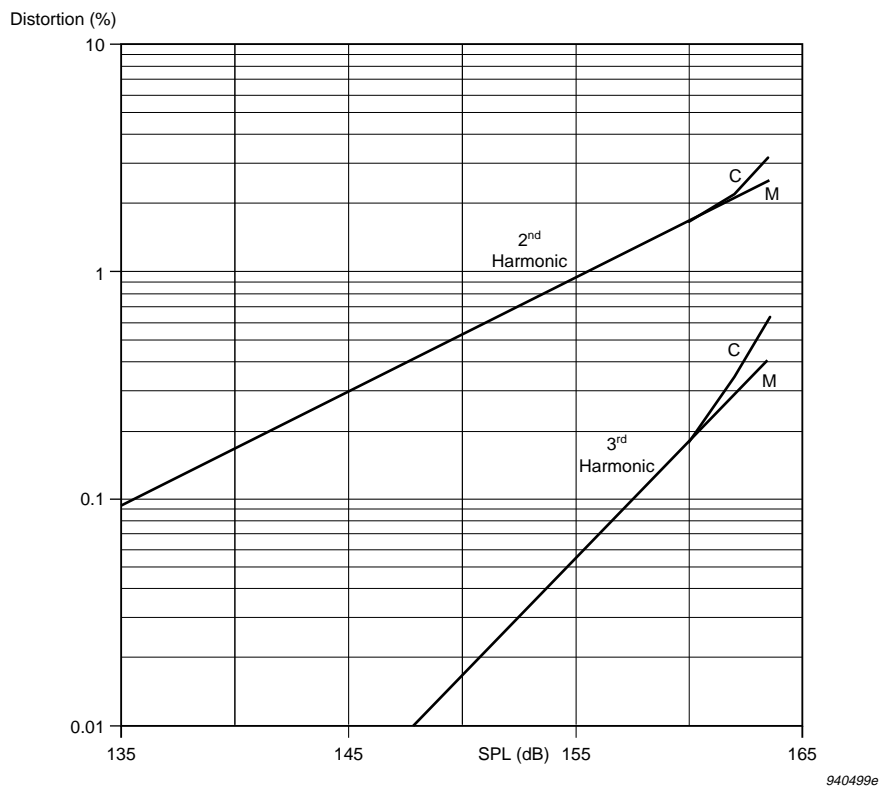

Fig. 6.17 Typical distortion characteristics of the microphone with $\frac{1}{2}$ " Microphone Preamplifier Type 2669 (C) and unloaded (M)

The distortion is dependent on the capacitance parallel to the microphone. It increases with increasing capacitance. The distortions given in [Table 6.3](#) and [Table 6.4](#) are valid for a parallel capacitance of 0.5 pF. The distortion is measured at 100 Hz but can be assumed to be valid up to approximately 5 kHz (that is, where the diaphragm displacement is predominantly stiffness-controlled). Distortion measurement methods for higher frequencies are not available.

Maximum Sound Pressure Level

In general, the microphone should not be exposed to sound pressure levels which produce voltages higher than the maximum input voltage specified for the connected preamplifier. After an overload, the preamplifier needs time to recover and, during this recovery period, you cannot measure validly. The maximum input voltage for most Brüel & Kjær preamplifiers is ± 50 V (with a 130 V supply). This voltage is

Lower Limit				Upper Limit	
1 Hz bandwidth at 1 kHz (dB)	1/3-octave band at 1 kHz (dB)	A-weighted (dB)	Linear 20 Hz to 20 kHz (dB)	< 3% distortion (dB)	Max. SPL (Peak) (dB)
-22.4	1.2	19.0	21.3	162	171

Table 6.3 Dynamic range of the microphone

Lower Limit				Upper Limit	
1 Hz bandwidth at 1 kHz (dB)	1/3-octave band at 1 kHz (dB)	A-weighted (dB)	Linear 20 Hz to 20 kHz (dB)	< 3% distortion (dB)	Max. SPL (Peak) (dB)
-18.2	5.4	20.7	25.4	161	166

Table 6.4 Dynamic range of the microphone with 1/2" Microphone Preamplifier Type 2669

produced by a nominal Pressure-field 1/2" Microphone Type 4192 at a Peak level of 166 dB (re 20 µPa).

The microphone will maintain its charge up to a Peak level of 171 dB (re 20 µPa). Above this level, the diaphragm and back plate short-circuit. If this occurs, the microphone needs one or two minutes to recharge before it is ready to measure validly. We recommend not to expose Pressure-field 1/2" Microphone Type 4192 to levels higher than 171 dB (Peak).

6.6 Equivalent Volume and Calibrator Load Volume

Equivalent Volume

For some applications it is practical to express the acoustic impedance of the microphone diaphragm in terms of a complex equivalent volume. This makes it easier to evaluate the effect of microphone loading on closed cavities or acoustic calibration couplers.

The real and imaginary parts of the equivalent volume shown in [Fig.6.18](#) are in parallel. They are calculated from a simple R-L-C series model of the microphone which gives the best overall approximation of the microphone's diaphragm impedance.

The Models

The following equivalent models are valid at 101.325 kPa, 23 °C and 50%RH:

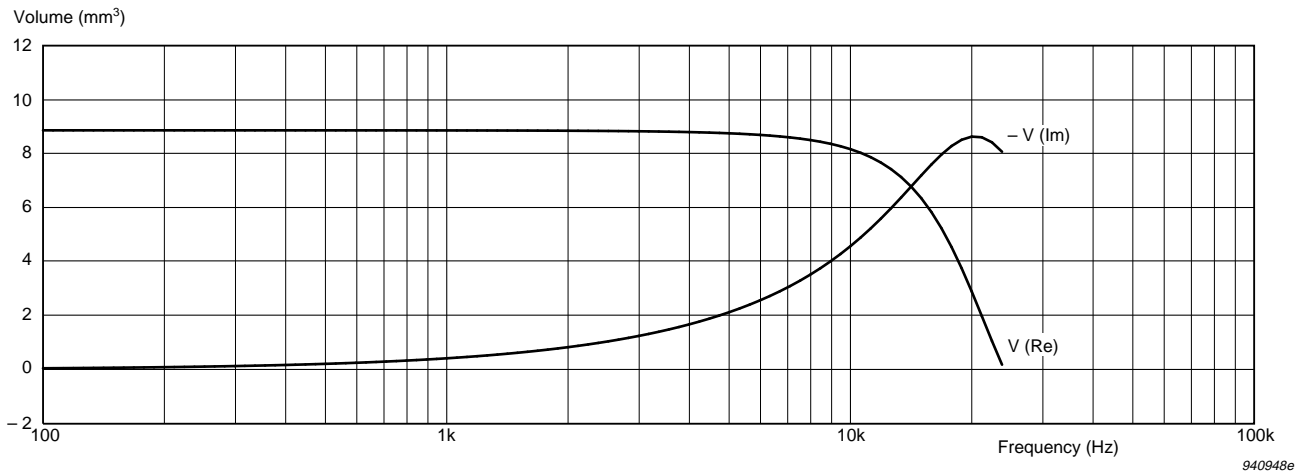

Fig 6.18 Typical equivalent volume (real and imaginary parts) based on mathematical model of microphone

Model 1

$$C = 0.062 \times 10^{-12} \text{ m}^5/\text{N}$$

$$L = 710 \text{ kg/m}^4$$

$$R = 119 \times 10^6 \text{ Ns/m}^5$$

where C = acoustic diaphragm compliance
 L = acoustic diaphragm mass
 R = acoustic diaphragm damping resistance

Model 2

$$V_{lf} = 8.8 \text{ mm}^3$$

$$f_0 = 24 \text{ kHz}$$

$$Q = 0.9$$

where V_{lf} = low-frequency volume
 f_0 = diaphragm resonance frequency
 Q = quality factor

Calibrator Load Volume

When the microphone with its protection grid is inserted into the coupler of a calibrator, it will load the calibrator by a volume of 190 mm^3 at 250 Hz.

Load volume correction to Pistonphone Type 4228 Calibration Level (with Adaptor DP 0776): +0.02 dB

6.7 Capacitance

The microphone's impedance is determined by its polarized capacitance. In addition, the preamplifier's input resistance and capacitance load the microphone. This loading determines the electrical lower limiting frequency and the capacitive input attenuation. However, with modern preamplifiers, this loading is very small and is included in the preamplifier gain, G (see [section 6.2.2](#)). Only in special cases with high capacitive loading does the fall in capacitance with frequency have to be taken into account.

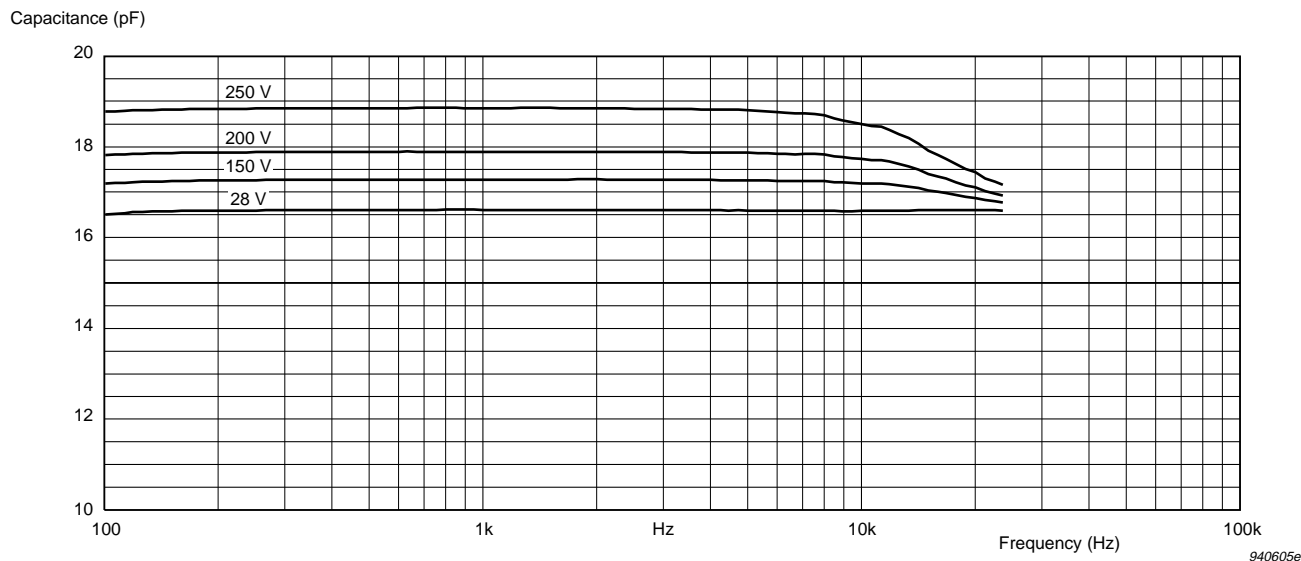

Fig. 6.19 Variation of capacitance with polarization voltage and frequency

Typical capacitance (at 250 Hz): 18 pF.

The capacitance is individually calibrated and stated on the calibration chart.

6.8 Polarization Voltage

Generally, a microphone is operated at its nominal polarization voltage. For Pressure-field $\frac{1}{2}$ " Microphone Type 4192, this is 200 V. As this polarization voltage is positive, the output voltage is negative for a positive pressure applied to the diaphragm.

In special cases where there is a risk of preamplifier overload or there are long cables to be driven, choose a lower voltage. This will cause a lower sensitivity (see [Fig. 6.20](#)) and a change in the frequency response (see [Fig. 6.21](#)).

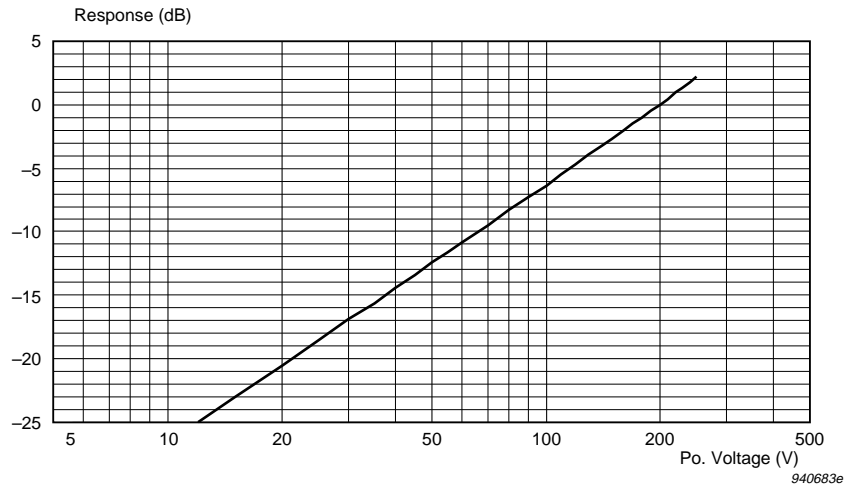

Fig.6.20 Variation in sensitivity (at 250 Hz) as a function of polarization voltage, relative to the sensitivity with a polarization voltage of 200 V

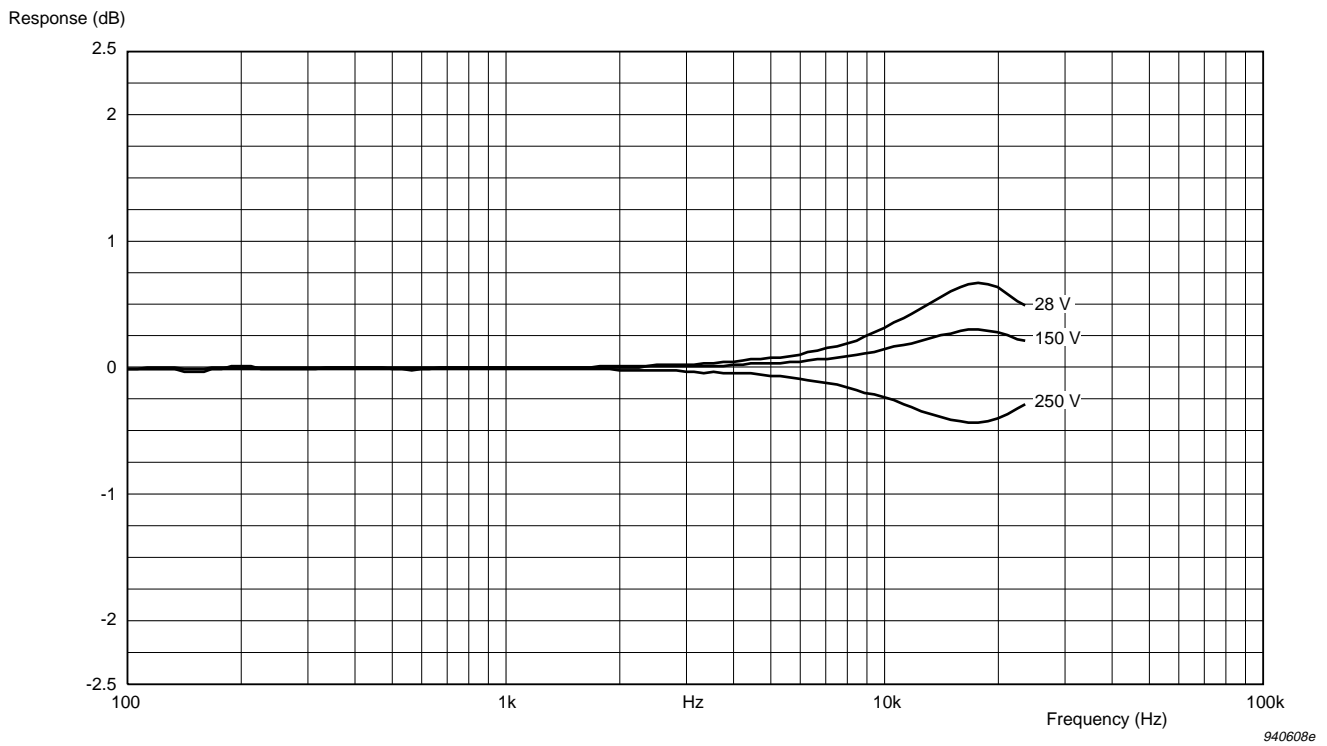

Fig.6.21 Effect of polarization voltage on frequency response. The curves show the difference from the response with a polarization voltage of 200 V (normalised at 250 Hz)

6.9 Leakage Resistance

To maintain the correct polarization voltage on the microphone, the microphone's leakage resistance must be at least 1000 times greater than the supply resistance of the polarization charge, even under the most severe environmental conditions. This resistance which is generally placed in the preamplifier, is typically 10^9 to $10^{10} \Omega$. Brüel & Kjær microphones have a very high leakage resistance which is greater than $5 \times 10^{15} \Omega$ at 90%RH and 23°C.

6.10 Stability

6.10.1 Mechanical Stability

The microphone's design with respect to mechanical stability is improved compared with traditional Brüel & Kjær microphones. The diaphragm clamping ring is less sensitive to accidental force and the protection grid is significantly reinforced. Therefore, the microphone can withstand mechanical shocks better than traditional Brüel & Kjær microphones.

The sensitivity change of the microphone is less than 0.1 dB after a free fall of 1 m onto a solid hardwood block (re IEC 68-2-32).

This improved mechanical stability makes Pressure-field 1/2" Microphone Type 4192 well-suited for surface mounting and for mounting in small couplers as no mechanical adaptor is required to protect the diaphragm clamping ring. The microphone can be supported by the diaphragm clamping ring directly on the coupler's surface. Any force of less than 5 Newtons will cause a change in sensitivity of less than 0.005 dB. This makes the microphone well-suited for fitting in small, plane wave couplers used for reciprocity calibration and any other small coupler with a well-defined volume.

6.10.2 High-temperature Stability

The diaphragm is made of a stainless steel alloy. The alloy has been carefully selected and is very resistant to heat. This means that the diaphragm tension (and therefore the sensitivity) remain the same, even after several hours' operation at high temperature.

The microphone has been tested at temperatures up to 300°C. Below 170°C, no changes occur. At 170°C, the sensitivity can be permanently changed within the first 10 hours by less than 0.025 dB. After this, the sensitivity can be permanently changed within the next 100 hours by a similar value. At 300°C, the sensitivity can be permanently changed within the first hour by +0.4 dB. After this, the sensitivity can be permanently changed within the next 10 hours by less than +0.4 dB.

Note: Special adaptors (inserted between the microphone and preamplifier) must be made for high-temperature applications in order to protect the preamplifier from heat conduction and radiation.

6.10.3 Long-term Stability

Over a period of time, the mechanical tension in the diaphragm will decrease due to stretching within the foil. This mechanism, which, in principle, causes an increased sensitivity, is, however, very weak for the microphone. Measurement of this mechanism is not possible at room temperature.

At present, no exact value can be given for the microphone's long-term stability but measured changes at high temperatures indicate that Pressure-field $\frac{1}{2}$ " Microphone Type 4192 is more than 10 times more stable than traditional Brüel & Kjær microphones. This indicates typical changes of less than 1 dB in 5000 years.

6.11 Effect of Temperature

By careful selection of materials, optimization of the design and artificial ageing, the effect of temperature has been made to be very low.

The microphone has been designed to operate at temperatures from -30 to 300°C . When the microphone is subjected to temperatures above 200°C , it may be discoloured but its functionality will remain unaffected. See [section 6.10.2](#) for permanent changes in sensitivity at temperatures above 170°C .

The reversible changes are shown in Fig.6.22 as a change in sensitivity and in Fig.6.23 to Fig.6.25 as changes in the frequency response normalized at 250 Hz.

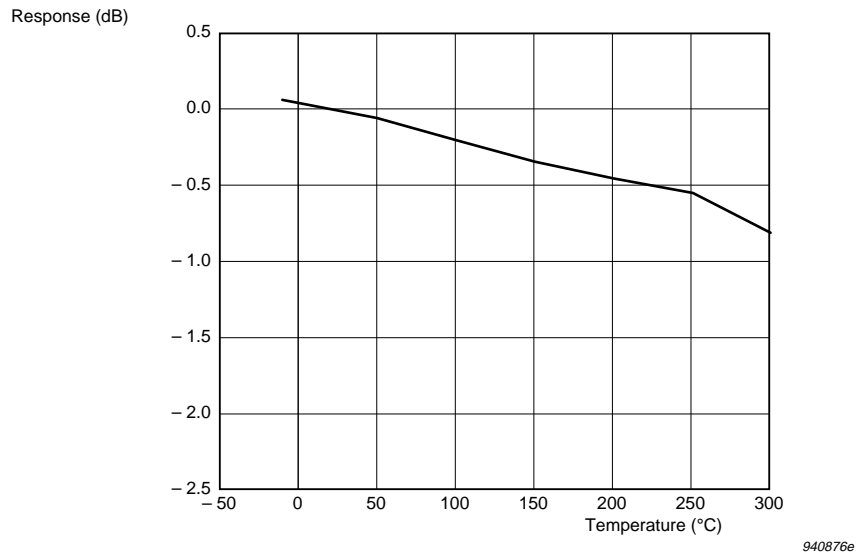

Fig. 6.22 Typical variation in sensitivity (at 250 Hz) as a function of temperature, relative to the sensitivity at 20°C

Temperature Coefficient (250 Hz):

-0.002 dB/°C, typical (for the range -10 to +50°C)

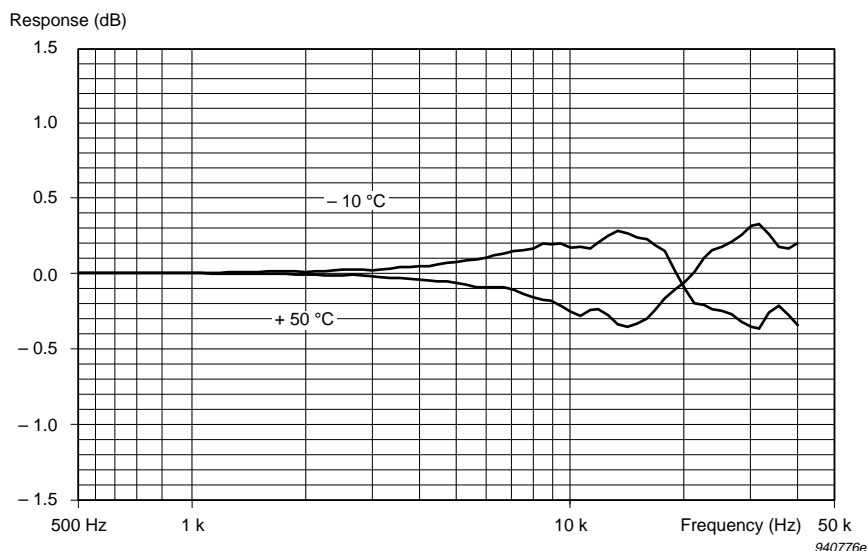

Fig.6.23 Typical variation in actuator response (normalized at 250 Hz) as a function of temperature, relative to the response at 20 °C (see Fig.6.4) over the temperature range defined by IEC 651

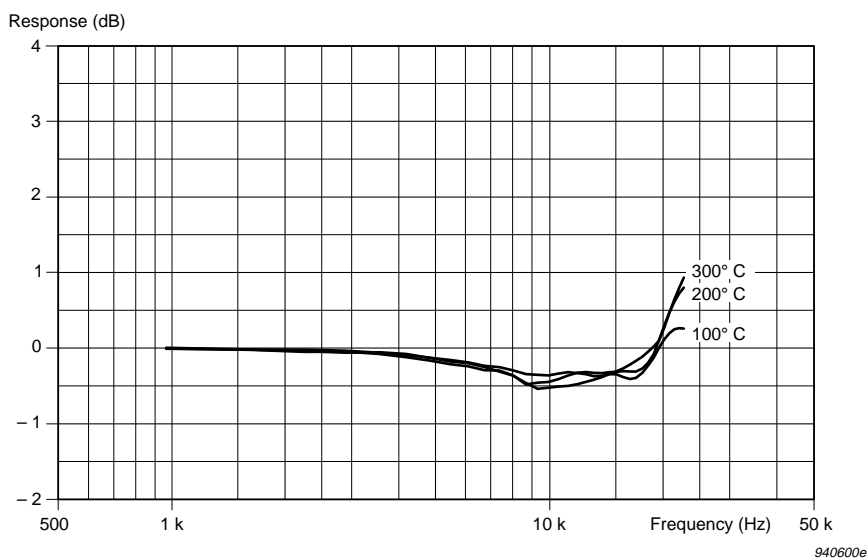

Fig.6.24 Typical variation in actuator response (normalized at 250 Hz) as a function of temperature, relative to the response at 20 °C (see Fig.6.4)

The effect of temperature on the free-field response (see Fig. 6.25) of the microphone is the sum of the following effects:

- the calculated effect of the change in the speed of sound due to temperature on the 0° -incidence free-field correction
- the measured change in the actuator response due to temperature (see Fig. 6.23).

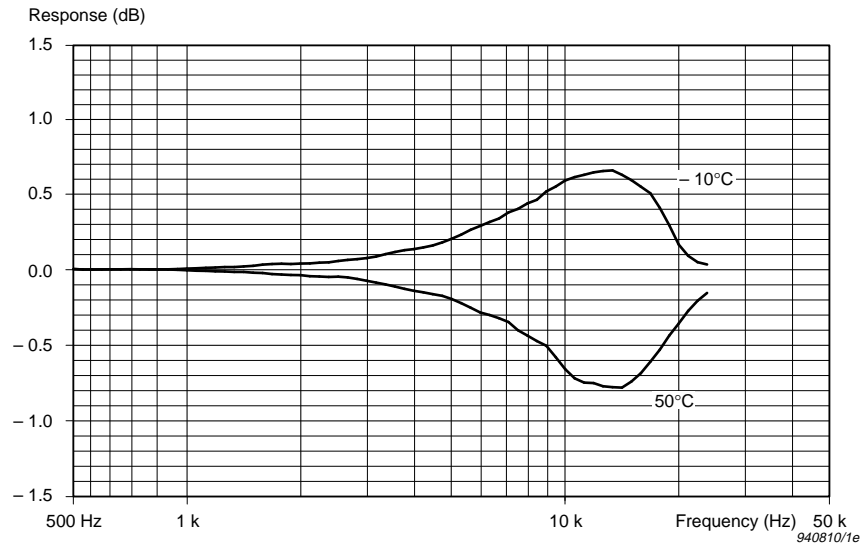

Fig. 6.25 Typical variation in 0° -incidence free-field response with Protection Grid DB3421 (normalized at 250 Hz) as a function of temperature, relative to the response at 20°C (see Fig. 6.7) over the temperature range defined by IEC 651

6.12 Effect of Ambient Pressure

The microphone's sensitivity and frequency response are affected by variations in the ambient pressure. This is due to changes in air stiffness in the cavity behind the diaphragm, and changes in air mass in the small gap between the diaphragm and the back plate. The effects are shown in Fig. 6.26 to Fig. 6.28.

The typical pressure coefficient at 250 Hz for Pressure-field $\frac{1}{2}$ " Microphone Type 4192 is -0.005 dB/kPa.

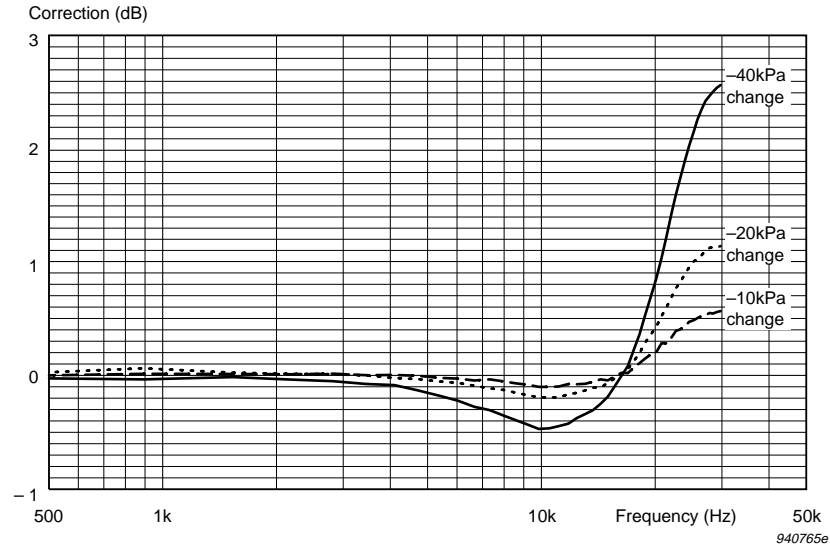

Fig.6.26 Typical variation in frequency response (normalized at 250 Hz) from that at 101.3 kPa as a function of change in ambient pressure

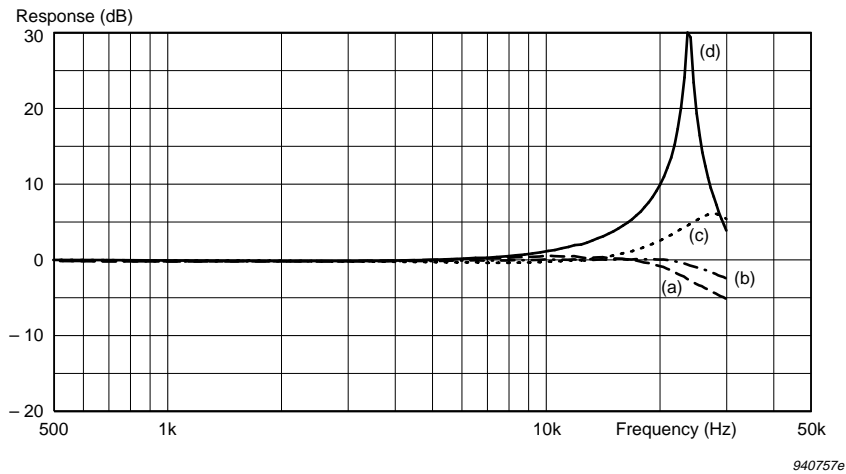

Fig.6.27 Typical effect of ambient pressure on actuator response (a) at 101.3 kPa (b) - 40 kPa change (c) - 80 kPa change (d) at 2 kPa

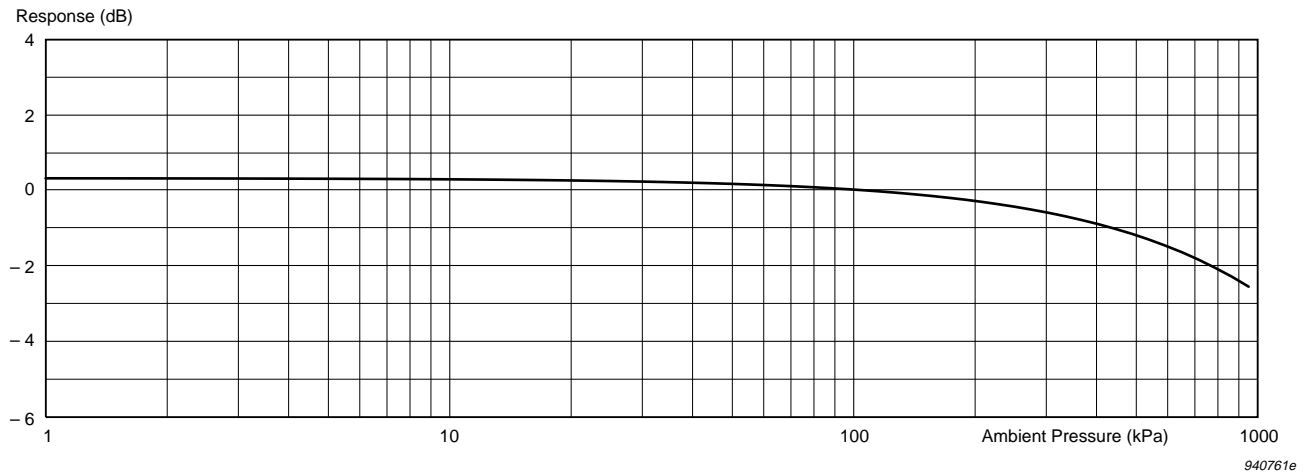

Fig. 6.28 Typical variation in sensitivity at 250 Hz from that at 101.3 kPa as a function of ambient pressure

6.13 Effect of Humidity

Due to the microphone's high leakage resistance, humidity has, in general, no effect on the microphone's sensitivity or frequency response. The microphone has been tested according to IEC 68-2-3 and the effects of humidity on the sensitivity at 250 Hz and the frequency response have been found to be less than 0.1 dB at up to 95% RH (non-condensing) and 40°C.

6.14 Effect of Vibration

The effect of vibration is determined mainly by the mass of the diaphragm and is at its maximum for vibrations applied normal to the diaphragm. A vibration signal of 1 m/s^2 RMS normal to the diaphragm typically produces an equivalent Sound Pressure Level of 65.5 dB for a microphone fitted with Protection Grid DB 3421.

6.15 Effect of Magnetic Field

The effect of a magnetic field is determined by the vector field strength and is normally at its maximum when the field direction is normal to the diaphragm. A magnetic field strength of 80 A/m at 50 Hz (the test level recommended by IEC and ANSI) normal to the diaphragm produces a typical equivalent Sound Pressure Level of 16 dB. Higher frequency components in the microphone output become dominant at field strengths greater than 500 to 1000 A/m.

6.16 Electromagnetic Compatibility

See [Chapter 8](#).

6.17 Specifications Overview

<p>OPEN-CIRCUIT SENSITIVITY (250 Hz)*: -38 dB \pm1.5 dB re 1 V/Pa, 12.5 mV/Pa*</p> <p>POLARIZATION VOLTAGE: External: 200 V</p> <p>FREQUENCY RESPONSE*: Pressure-field response: 5 Hz to 12.5 kHz: \pm1 dB 3.15 Hz to 20 kHz: \pm2 dB In accordance with ANSI S1.4 -1983, Type 1 and ANSI S1.12, Type M</p> <p>LOWER LIMITING FREQUENCY (-3 dB): 1 Hz to 2 Hz (vent exposed to sound)</p> <p>PRESSURE EQUALIZATION VENT: Side vented</p> <p>DIAPHRAGM RESONANCE FREQUENCY: 23 kHz, typical (90° phase shift)</p> <p>CAPACITANCE (POLARIZED)*: 18 pF, typical (at 250 Hz)</p> <p>EQUIVALENT AIR VOLUME (101.3 kPa): 8.8 mm³</p> <p>_____</p> <p>* Individually calibrated</p>	<p>CALIBRATOR LOAD VOLUME (250 Hz): 190 mm³</p> <p>PISTONPHONE TYPE 4228 CORRECTION: with DP 0776: +0.02 dB</p> <p>TYPICAL CARTRIDGE THERMAL NOISE: 19.0 dB (A) 21.3 dB (Lin.)</p> <p>UPPER LIMIT OF DYNAMIC RANGE: 3% distortion: >162 dB SPL</p> <p>MAXIMUM SOUND PRESSURE LEVEL: 171 dB (peak)</p> <p>OPERATING TEMPERATURE RANGE: -30 to +150°C (-22 to 302°F) can be used up to +300°C (572°F) but with a permanent sensitivity change of typically +0.4 dB which stabilises after one hour</p> <p>OPERATING HUMIDITY RANGE: 0 to 100% RH (without condensation)</p> <p>STORAGE TEMPERATURE: -30 to +70°C (-22 to 158°F)</p> <p>TEMPERATURE COEFFICIENT (250 Hz): -0.002 dB/°C, typical (for the range -10 to +50°C)</p>	<p>PRESSURE COEFFICIENT (250 Hz): -0.005 dB/kPa, typical</p> <p>INFLUENCE OF HUMIDITY: <0.1 dB/100% RH</p> <p>VIBRATION SENSITIVITY (<1000 Hz): Typically 65.5 dB equivalent SPL for 1 m/s² axial acceleration</p> <p>MAGNETIC FIELD SENSITIVITY: Typically 16 dB SPL for 80 A/m, 50 Hz field</p> <p>ESTIMATED LONG-TERM STABILITY: >1 000 years/dB at 20°C >1 00 hours/dB at 150°C</p> <p>DIMENSIONS: Diameter: 13.2 mm (0.52 in) (with grid) 12.7 mm (0.50 in) (without grid) Height: 13.5 mm (0.54 in) (with grid) 12.6 mm (0.50 in) (without grid) Thread for preamplifier mounting: 11.7 mm – 60 UNS</p> <p>The data above are valid at 23°C, 101.3 kPa and 50%RH, unless otherwise specified.</p>
---	---	---

6.18 Ordering Information

Preamplifier

Type 2669: $\frac{1}{2}$ " Microphone Preamplifier

Calibration Equipment

Type 4231: Sound Level Calibrator

Type 4226: Multifunction Acoustic Calibrator

Type 4228: Pistonphone

UA 0033: Electrostatic Actuator

Other Accessories

UA 0254: Set of 6 Windscreens (UA 0237) 90 mm (3.5 in)

UA 0469: Set of 6 Windscreens (UA 0459) 65 mm (2.6 in)

Chapter 7

Low-frequency Pressure-field 1/2" Microphone Type 4193

7.1 Introduction

7.1.1 Description



Fig 7.1 Low-frequency Pressure-field $\frac{1}{2}$ " Microphone Type 4193 with Protection Grid DB 3421 and Adaptor UC 0211 (included)

Low-frequency Pressure-field $\frac{1}{2}$ " Microphone Type 4193 is an externally-polarized $\frac{1}{2}$ " pressure-field microphone. With its low inherent noise and frequency range extending all the way from 70 mHz to 20 kHz, it is very well suited for measuring infrasound, for example in ships engine rooms, in helicopters and in wind-buffeted buildings. Furthermore, it satisfies the requirements of ANSI S 1.4 Type 1 and ANSI S 1.12 Type M.

This microphone is supplied with a special Low-frequency Adaptor UC 0211 which, because of the extra capacitance it introduces, has the effect of reducing the lower cut-off frequency of the preamplifier — in the case of $\frac{1}{2}$ " Microphone Preamplifier Type 2669, down to 0.1 Hz.

The microphone requires a polarization voltage of 200 V, provided by the instrument or analyzer powering the associated preamplifier.

This rugged microphone is built to ensure high stability under a variety of conditions. For example, the stainless steel alloy diaphragm withstands polluted industrial environments. The diaphragm clamping ring is firmly secured to ensure the microphone's reliability, even when the microphone is used without its protection grid. When the microphone is used without its protection grid, it can be easily

flush-mounted or inserted into closed volumes as it can be supported by the diaphragm clamping ring, provided that a force of less than 5 Newtons is applied.

The microphone is supplied with individual calibration data on a calibration chart and on a $3\frac{1}{2}$ " data disk in a case. This case can also contain a $1/2$ " Microphone Preamplifier Type 2669.

7.1.2 The Calibration Chart

Each microphone is supplied with an individual calibration chart (see Fig. 7.2) which gives the microphone's open-circuit sensitivity, polarized capacitance, cut-off frequency and pressure-field and random-incidence frequency responses. The data is valid for a microphone without Adaptor UC 0211 fitted.

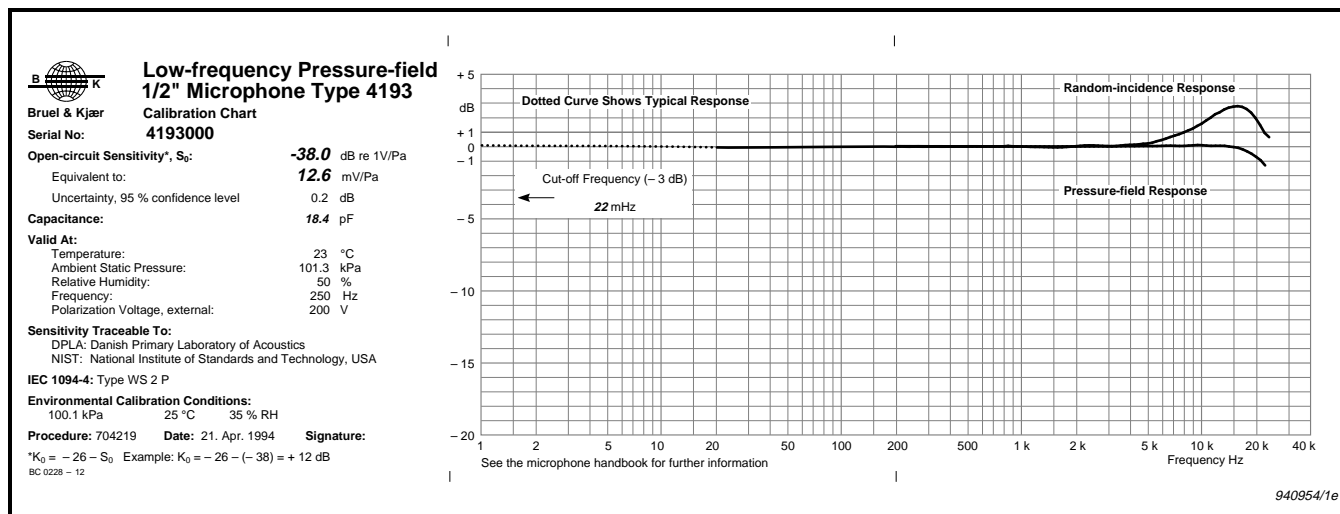

Fig. 7.2 Microphone calibration chart

Open-circuit Sensitivity

The stated open-circuit sensitivity is valid at the reference frequency (251.2 Hz^{*}) for free-field, random-incidence and pressure-field conditions. The stated uncertainty is the U_{95} value (the value valid for 95% confidence level).

Ambient Conditions

The ambient conditions are measured continuously during calibration at the factory. The calibration results obtained at the measured Environmental Calibration Conditions are corrected to the reference ambient conditions stated under Valid At (23 °C, 101.325 kPa and 50 % RH).

*The exact reference frequency is $10^{2.4}$ Hz (re ISO 266).

Frequency Responses

Two frequency responses are shown on the calibration chart. Both are normalized to 0 dB at the reference frequency (251.2 Hz*).

The lower curve on the calibration chart is the individual microphone's open-circuit pressure-field response. This response is the optimized response for Low-frequency Pressure-field 1/2" Microphone Type 4193.

The upper curve on the calibration chart is the random-incidence response.

Both curves are determined by adding the relevant correction curve to the individual actuator response measured with Electrostatic Actuator UA 0033. The individual microphone's electrostatic actuator response is also available on the data disk.

The dotted part of the curve is the typical low-frequency response. Each microphone's individual lower limiting frequency is measured to ensure that it is within the specified tolerances (see Fig.7.3).

7.1.3 Data Disk

File Name	Content	Frequency Range
S#####.BKM ^a	Sensitivity calibration	251.2 Hz
A#####.BKM ^a	Actuator response	200 Hz – 22 kHz
P#####.BKR ^b	Pressure-field response	1 Hz – 22 kHz
4193L.BKT ^c	Low-frequency response	1 Hz – 190 Hz
4193F.BKC ^d	Free-field corrections without protection grid	200 Hz – 22 kHz
4193FG.BKC ^d	Free-field corrections with protection grid	200 Hz – 22 kHz
4193R.BKC ^d	Random-incidence corrections without protection grid	200 Hz – 22 kHz
4193RG.BKC ^d	Random-incidence corrections with protection grid	200 Hz – 22 kHz
4193P.BKC ^d	Pressure-field corrections	200 Hz – 22 kHz

Table 7.1 Calibration data and corrections contained on the data disk. Note: ##### is the microphone's serial number

a. Individual calibration data (measured).

b. Low-frequency response combined with actuator response and free-field corrections.

c. Typical response for Low-frequency Pressure-field 1/2" Microphone Type 4193.

d. Corrections for Low-frequency Pressure-field 1/2" Microphone Type 4193.

The 3 1/2" data disk supplied with each microphone supplements the calibration chart. It contains individual calibration data and correction curves (see Table 7.1) with a frequency resolution of 1/12-octave as comma-separated ASCII text files under the \DATA directory.

These text files can be viewed on Microsoft® Windows™ using the Brüel & Kjær Microphone Viewer program (BK-MIC.EXE) supplied on the disk. They can also be accessed by a suitable spreadsheet for further processing or printing.

Brüel & Kjær Microphone Viewer must be installed before use (see [section 1.3.5](#)).

7.1.4 Adaptor UC 0211

Adaptor UC 0211 is for use of Low-frequency Pressure-field $\frac{1}{2}$ " Microphone Type 4193 with microphone preamplifiers Types 2669 and 2639. The adaptor lowers the electrical lower-limiting frequency (the -3 dB point) of the microphone/preamplifier combination to 0.1 Hz (see [section 7.3.2](#) and [section 7.3.4](#)).

The adaptor's capacitance is 100 pF and it increases the preamplifier's input capacitance.

In addition to extending the microphone/preamplifier combination's frequency range, the adaptor also:

- Lowers the sensitivity (see [section 7.2](#))
- Increases the inherent noise (see [Table 7.4](#))
- Reduces the 3% distortion limit (see [Table 7.4](#))
- Slightly changes the frequency response due to varying input capacitance with frequency (see [Fig. 7.20](#) and [section 7.3.1](#))

7.1.5 Recommended Recalibration Interval

With normal handling of the microphone and any associated instrument, Brüel & Kjær recommends that the microphone be recalibrated every 2 years.

Low-frequency Pressure-field $\frac{1}{2}$ " Microphone Type 4193 is very stable over this period (see [section 7.10](#) to [section 7.12](#)). Improper handling is by far the most likely cause of change in the microphone's properties. Any damage which causes improper operation can probably be detected using a sound level calibrator. In many cases, the damage can be seen by carefully inspecting the protection grid and diaphragm.

7.2 Sensitivity

7.2.1 Open-circuit Sensitivity

The open-circuit sensitivity is defined as the sensitivity of the microphone when not loaded by the input impedance of the connected preamplifier (the termination is described in IEC 1094-2). The sensitivity is measured for the individual microphone at 251.2 Hz and stated on the microphone's calibration chart (see [section 7.1.2](#)) and

data disk (see [section 7.1.3](#)). The nominal sensitivity for a microphone without Adaptor UC 0211 fitted is shown in [Table 7.2](#).

Nominal open-circuit sensitivity		Accepted Deviation (dB)
mV/Pa	dB re 1 V/Pa	
12.5	-38	± 1.5

Table 7.2 Nominal open-circuit sensitivity

7.2.2 Loaded Sensitivity

When loaded by a preamplifier, the sensitivity of the microphone is given by:

$$S_C = S_O + G \quad (7.1)$$

where S_C = overall sensitivity of microphone and preamplifier combination
 S_O = open-circuit sensitivity of microphone
 G = voltage gain of microphone and preamplifier combination (in dB)

With Microphone Preamplifier Type 2639: $G = -0.1$ dB

With 1/2" Microphone Preamplifier Type 2669: $G = -0.2$ dB

With 1/2" Microphone Preamplifier Type 2669 and Adaptor UC 0211: $G = -16.5$ dB (± 1 dB)

Example

Loaded sensitivity of typical microphone with 1/2" Microphone Preamplifier Type 2669:

$$S_C = -38.3 + (-0.2) = -38.5 \text{ dB}$$

Loaded sensitivity of typical microphone with 1/2" Microphone Preamplifier Type 2669 and Adaptor UC 0211:

$$S_C = -38.3 + (-16.5) = -54.8 \text{ dB}$$

7.2.3 K-factor

Some types of Brüel & Kjær instruments use the K-factor (correction factor) or the K_O -factor (open-circuit correction factor) for calibration.

$$K = -26 - S_C \quad (7.2)$$

$$K_O = -26 - S_O \quad (7.3)$$

Example

Correction factor for typical microphone with 1/2" Microphone Preamplifier Type 2669:

$$K = -26 - (-38.5) = +12.5 \text{ dB}$$

Open-circuit correction factor for typical microphone with 1/2" Microphone Preamplifier Type 2669:

$$K_O = -26 - (-38.3) = +12.3 \text{ dB}$$

7.3 Frequency Response

7.3.1 General

In acoustic measurements, there are three types of sound field:

- Free field
- Pressure field
- Diffuse field

The microphone is optimized to have a flat frequency response in one of these sound fields. This response is called the optimized response. A microphone's response in a diffuse field is equivalent to its random-incidence response.

This section shows the microphone's typical free-field, pressure-field and random-incidence responses together with the microphone's typical actuator response obtained using Electrostatic Actuator UA 0033. The low-frequency response described in [section 7.3.4](#) is common for all types of response.

All frequency responses and correction curves shown are valid for a microphone without Adaptor UC 0211 fitted. If the adaptor is used with 1/2" Microphone Preamplifier Type 2669 to obtain an extended low-frequency response, the frequency response from 100 Hz to 10 kHz will roll off by less than 0.1 dB, and up to 20 kHz by less than 0.5 dB.

All frequency responses and correction curves are shown with a frequency resolution of 1/12-octave.

7.3.2 Optimized Response (Pressure-field Response)

The frequency response of Low-frequency Pressure-field 1/2" Microphone Type 4193 meets the requirements of ANSI S1.4 -1983, Type 1 and ANSI S1.12, Type M.

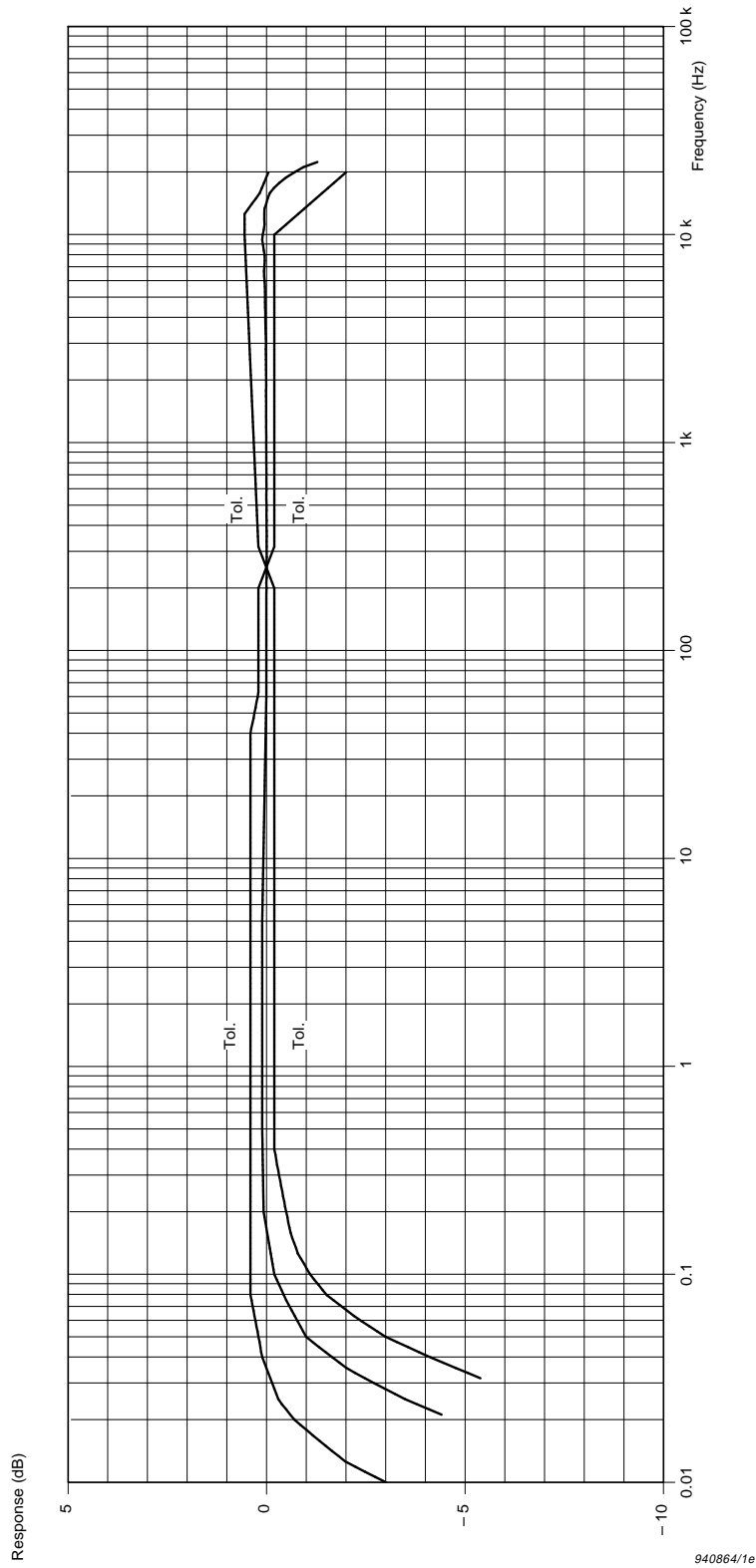

Fig. 7.3 Typical pressure-field response of the microphone with Protection Grid DB 3421 and the microphone's specified tolerances. The low-frequency response is valid when the vent is exposed to the sound field

7.3.3 Actuator Response

The microphone's frequency response is determined by adding corrections for the type of sound field to its actuator response obtained using Electrostatic Actuator UA 0033. This is a reproducible and practical method for calibrating a microphone's frequency response.

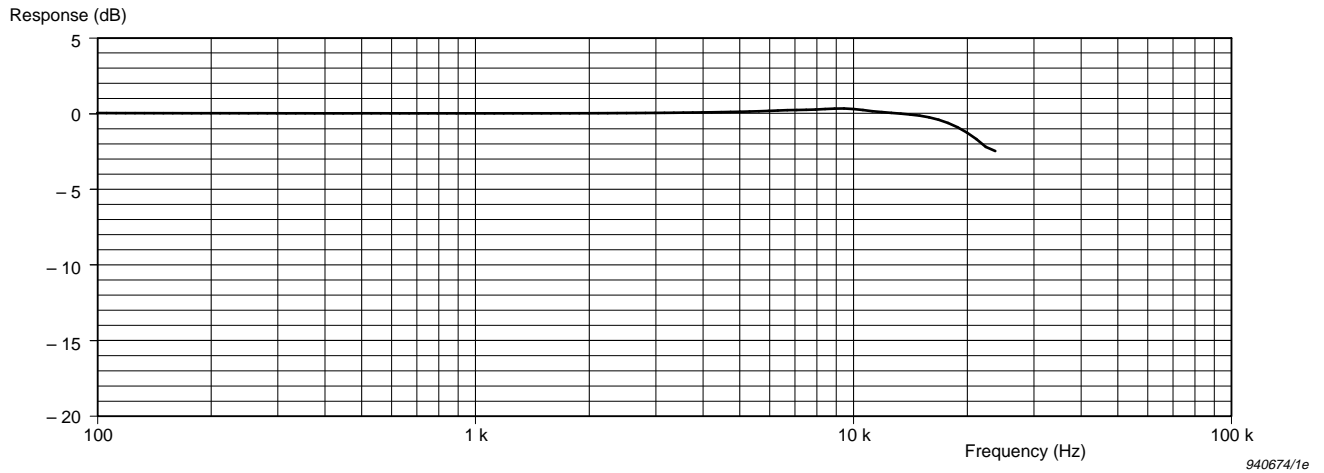

Fig. 7.4 Typical actuator response measured with Electrostatic Actuator UA 0033

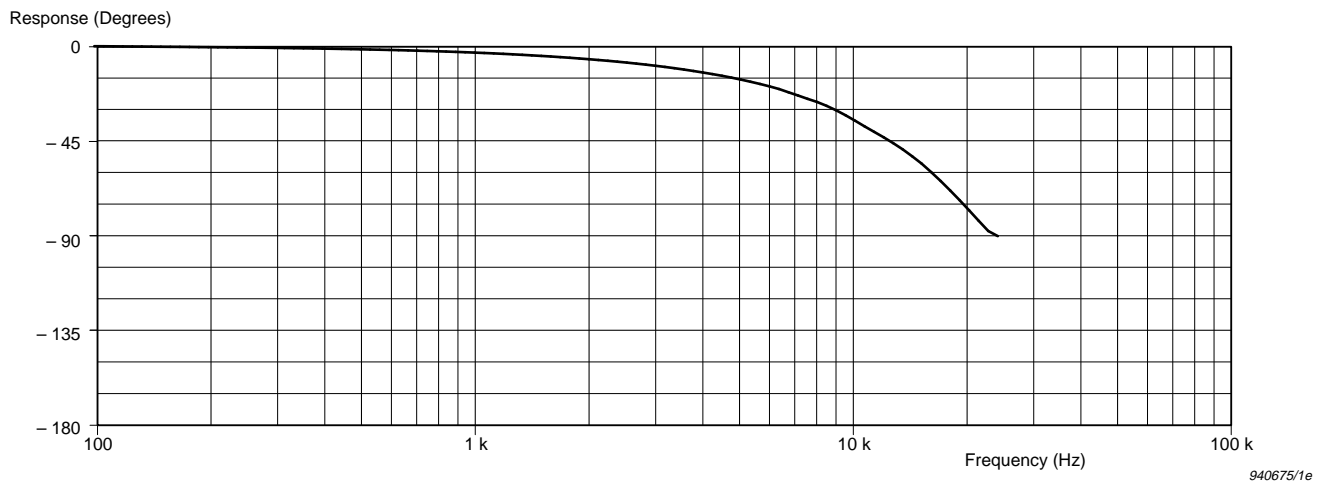

Fig. 7.5 Typical actuator phase response measured with Electrostatic Actuator UA 0033

If the polarization voltage is positive (as it is with Brüel & Kjær instruments), the output voltage is negative for a positive pressure applied to the diaphragm.

7.3.4 Low-frequency Response

The low-frequency response (see [Fig.7.3](#)) is the typical response with the vent exposed to the sound field. If the vent is not exposed to the sound field, the sensitivity increases from 0 dB at the reference frequency (251.2 Hz) to approximately 0.2 dB at 1 Hz.

For applications where the vent is not exposed to the sound field, take care to ensure proper static pressure equalization to prevent static displacement of the diaphragm.

The microphone's low-frequency response is common for all types of sound field.

The microphone's lower limiting frequency (-3 dB) is between 10 and 50 mHz with the vent exposed to the sound field. If used with Adaptor UC 0211 and $\frac{1}{2}$ " Microphone Preamplifier Type 2669, the microphone's lower limiting frequency (-3 dB) is below 0.1 Hz with the vent exposed to the sound field. The individual microphone's lower limiting frequency (-3 dB) is stated on its calibration chart.

7.3.5 Free-field Response

The microphone's free-field correction curves are shown in [Fig.7.6](#) and [Fig.7.8](#). These corrections are added to the microphone's actuator response obtained using Electrostatic Actuator UA 0033 in order to determine the free-field response at any angle of incidence. The typical free-field response at 0° incidence with and without the protection grid are shown in [Fig.7.7](#) and [Fig.7.9](#).

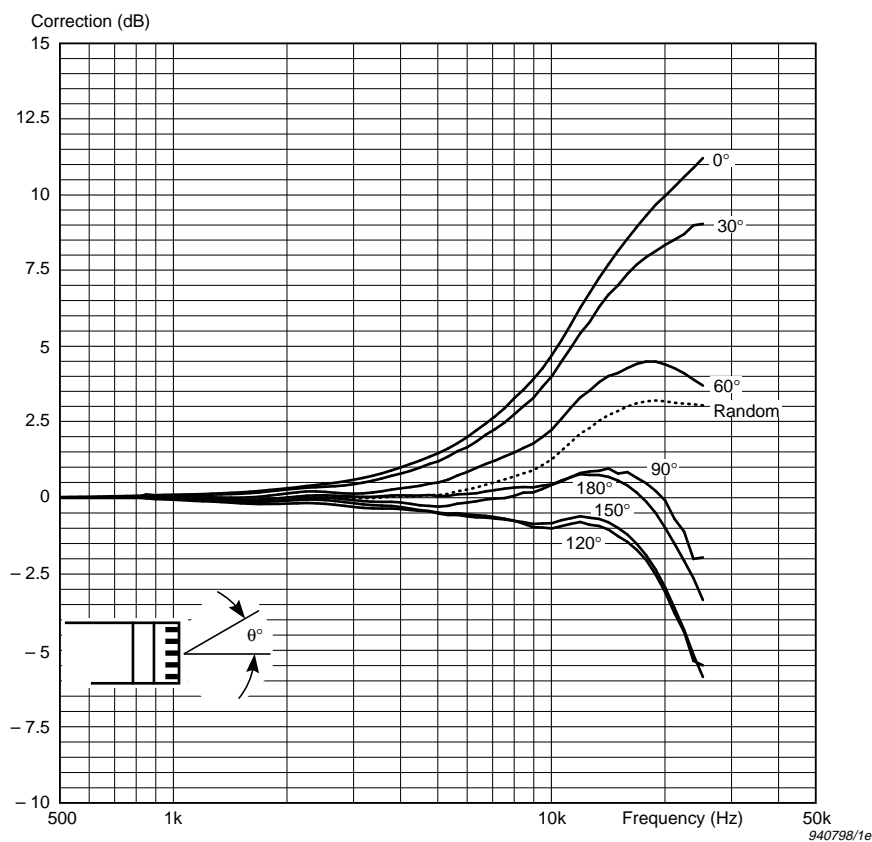

Fig. 7.6 Free-field correction curves for the microphone with Protection Grid DB 3421

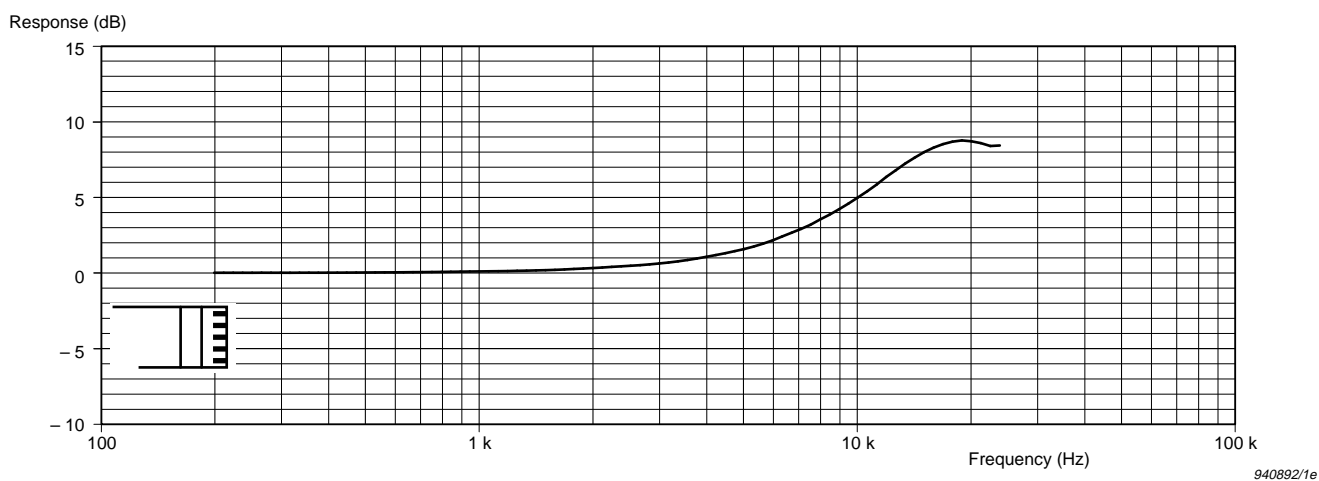

Fig. 7.7 Typical free-field response (0° incidence) for the microphone with Protection Grid DB 3421

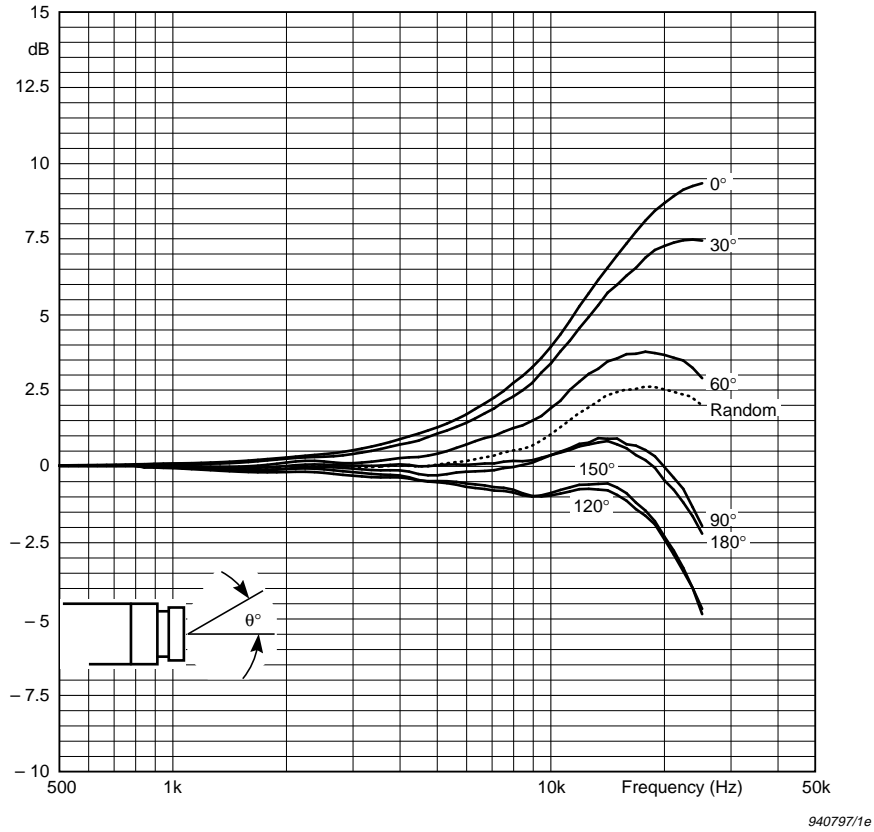

Fig 7.8 Free-field correction curves for the microphone without protection grid

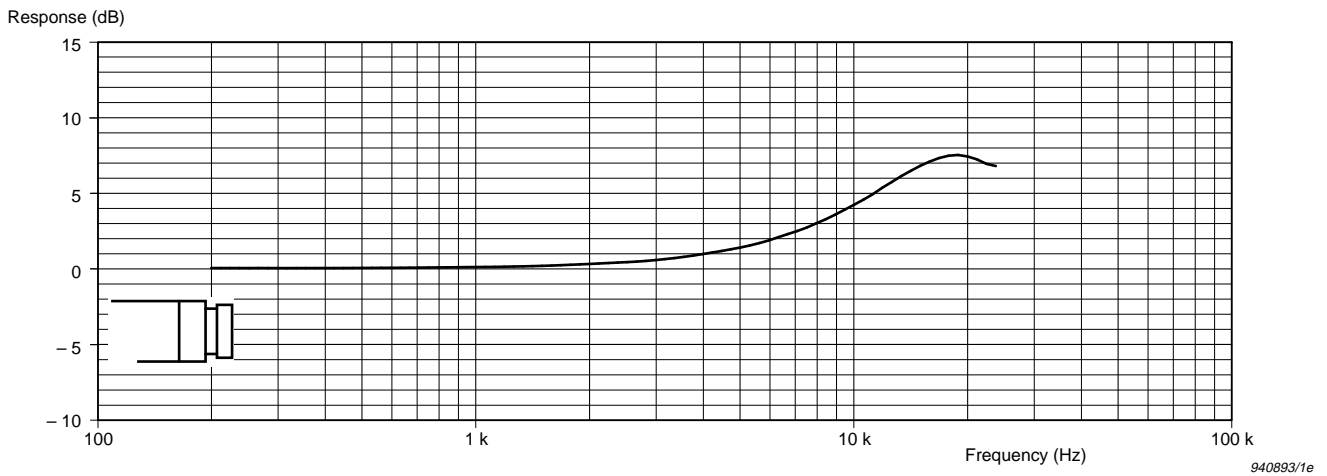

Fig. 7.9 Typical free-field response (0° incidence) for the microphone without protection grid

7.3.6 Random-incidence Response

A microphone's response in a diffuse sound field is equivalent to its random-incidence response. The microphone's random-incidence correction curves are shown in Fig. 7.6 and Fig. 7.8. These corrections are added to the microphone's actuator response obtained using Electrostatic Actuator UA 0033 in order to determine the random-incidence response. The typical random-incidence response with and without the protection grid are shown in Fig. 7.10 and Fig. 7.11.

The random-incidence corrections are calculated from the free-field corrections measured in 5° steps according to Draft IEC 1183–1993.

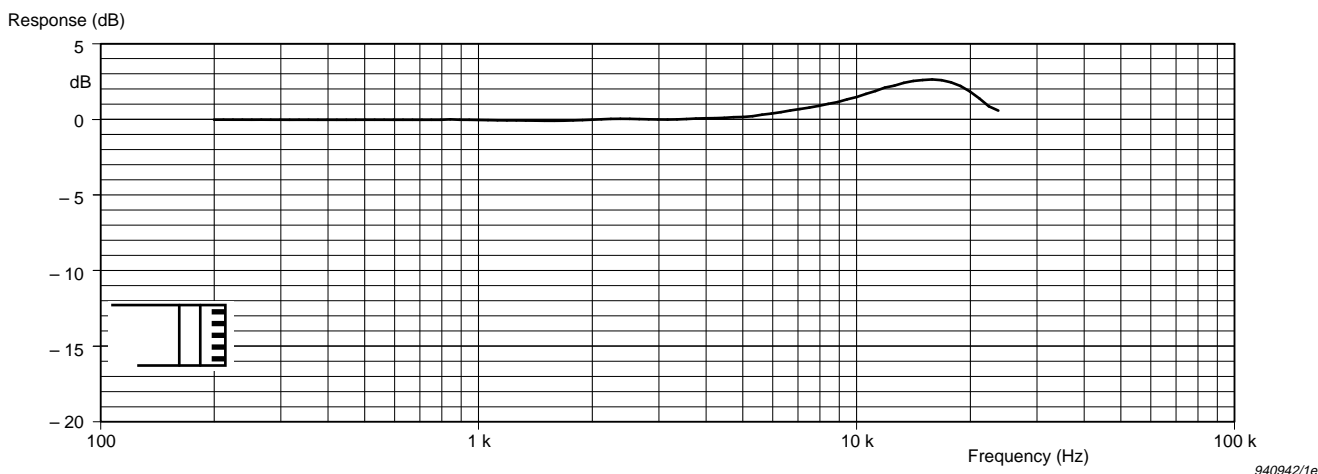

Fig. 7.10 Typical random-incidence response for the microphone with Protection Grid DB 3421

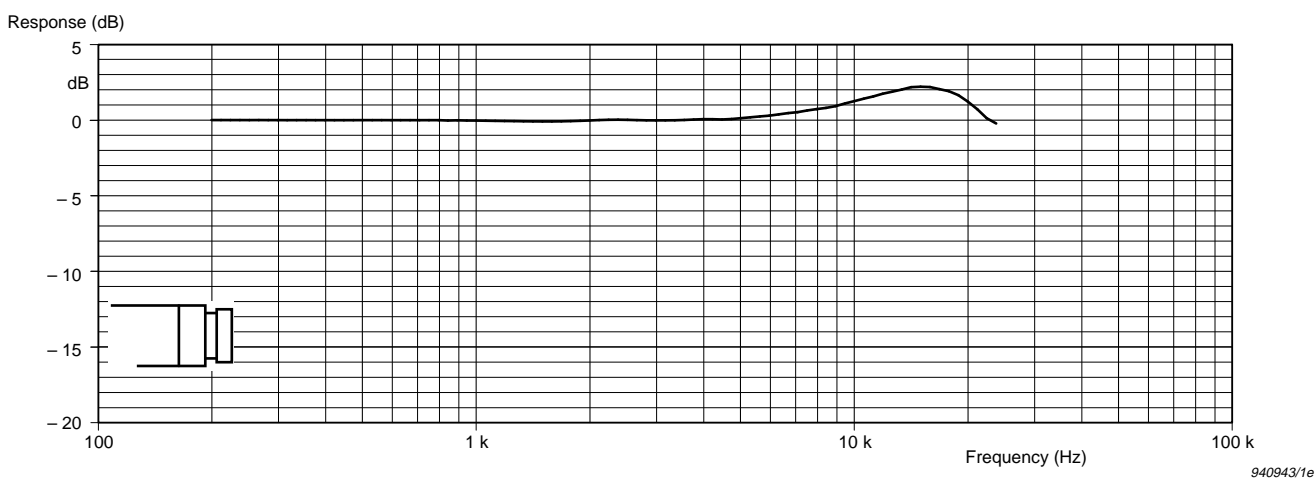

Fig. 7.11 Typical random-incidence response for the microphone without protection grid

7.3.7 Pressure-field Response

The microphone's pressure-field correction curve is shown in Fig. 7.12. This correction is added to the microphone's actuator response obtained using Electrostatic Actuator UA 0033 in order to determine the pressure-field response. The typical pressure-field response is shown in Fig. 7.13.

In practice, the pressure-field response is often regarded as being equal to the actuator response as the difference between them is small compared to the uncertainty related to many types of measurement.

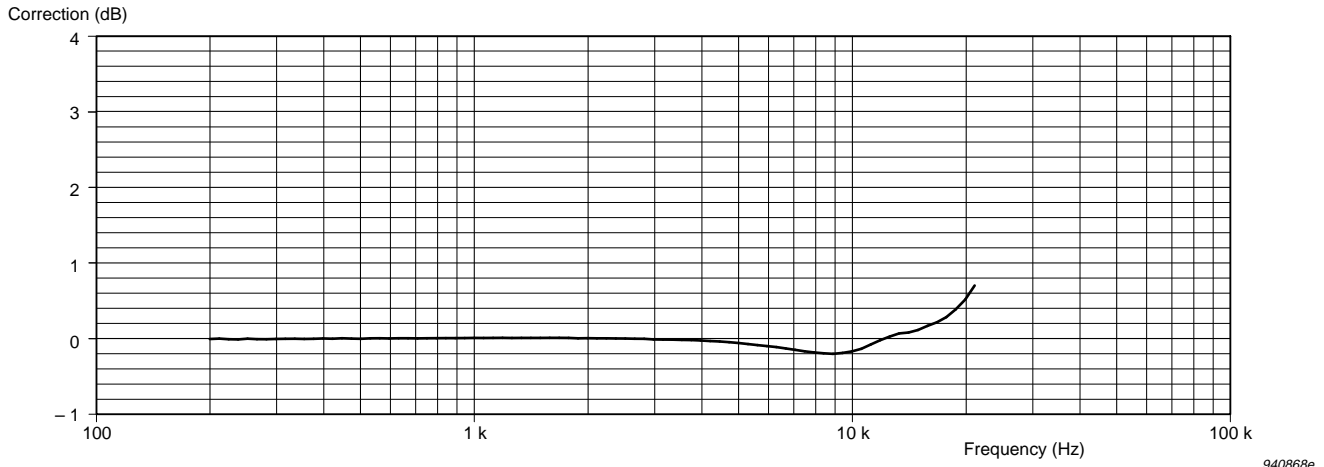

Fig. 7.12 Pressure-field correction for the microphone

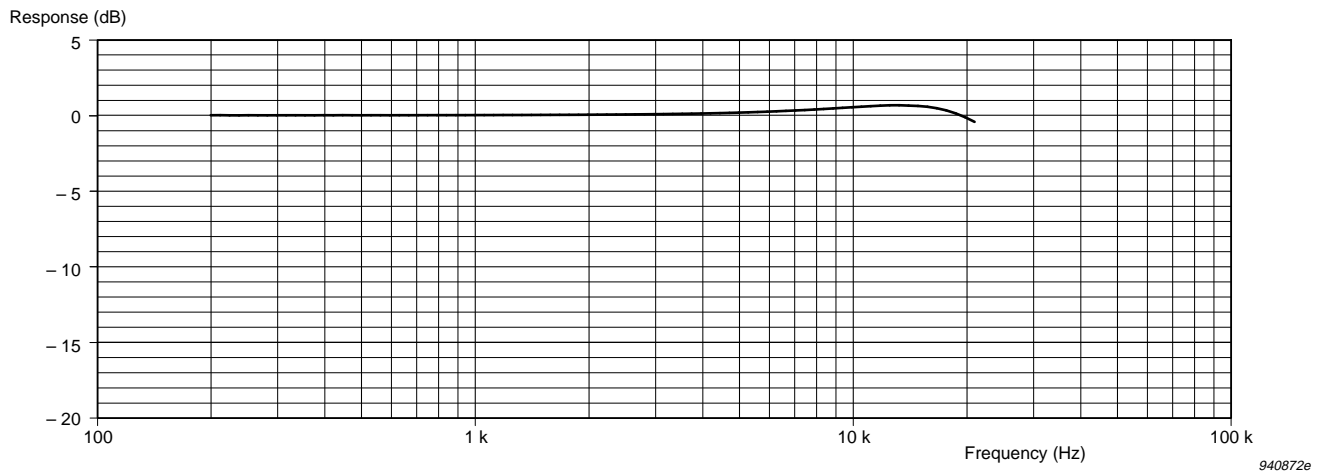
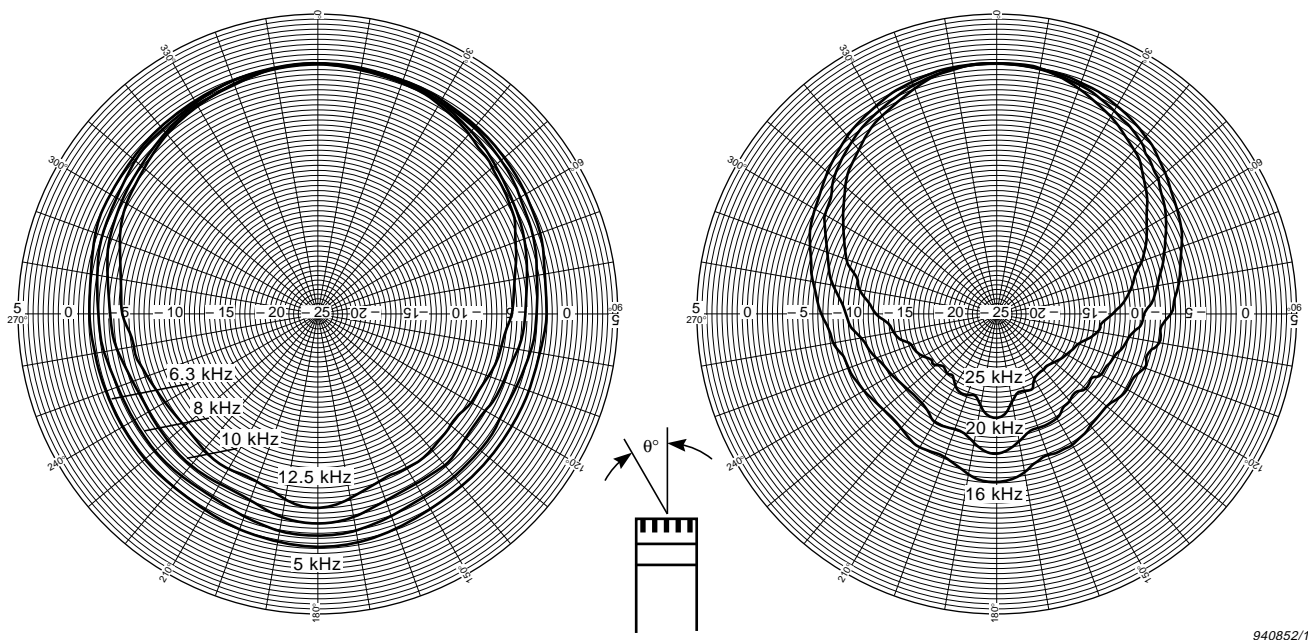

Fig. 7.13 Typical pressure-field response for the microphone

7.4 Directional Characteristics

Typical directional characteristics are given in Fig. 7.14 and Fig. 7.15. The characteristics are normalised relative to the 0° response.



940852/1e

Fig. 7.14 Typical directional characteristics of the microphone with Protection Grid DB 3421

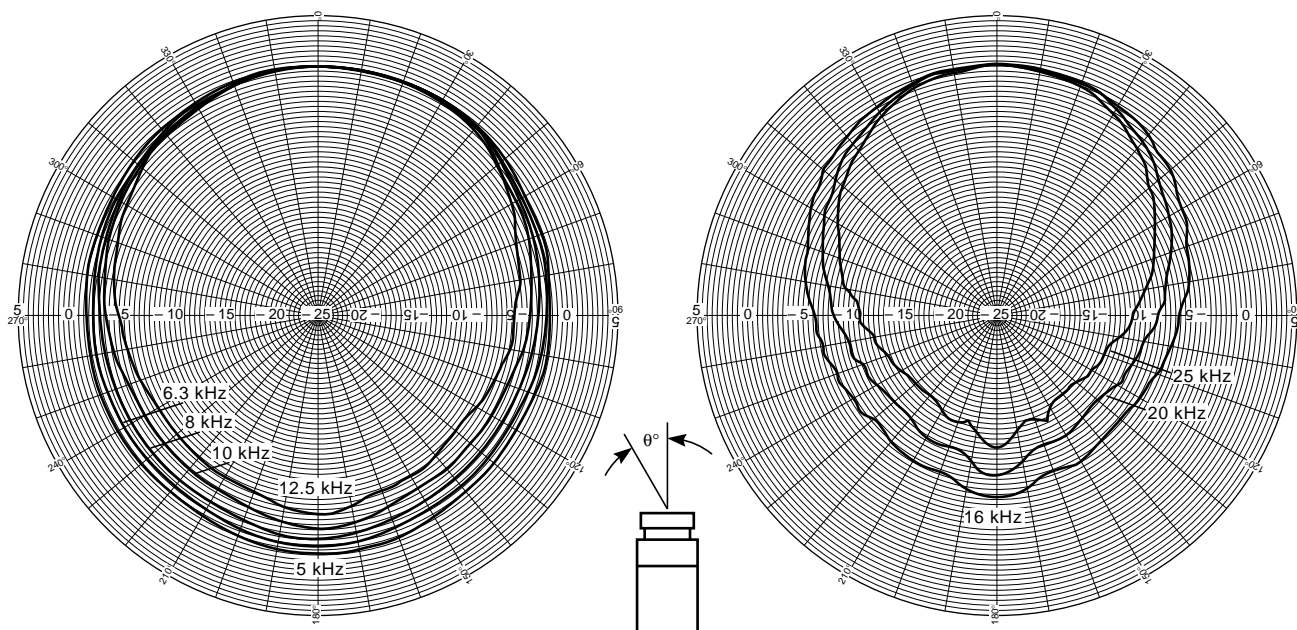

940853/1e

Fig. 7.15 Typical directional characteristics of the microphone without protection grid

7.5 Dynamic Range

Definition

The dynamic range is the range between the upper limit (determined by distortion) and the inherent noise floor. Both limits are influenced by the preamplifier. This section gives values for the microphone with and without a preamplifier.

Inherent Noise

The microphone's inherent noise is due to thermal movements of the diaphragm. These vary proportionally with the square root of the absolute temperature (in °K). The inherent noise increases with increasing temperature. With reference to 20 °C, the inherent noise changes by +0.5 dB at 55 °C and by -0.5 dB at -12 °C. The maximum variation of inherent noise for different samples of Low-frequency Pressure-field $\frac{1}{2}$ " Microphone Type 4193 is ± 1 dB.

The preamplifier's effect on the inherent noise of the combined microphone and preamplifier depends on the sensitivity and capacitance of the microphone (for $\frac{1}{2}$ " Microphone Preamplifier Type 2669, see Fig. 7.16 and [Chapter 8](#)). When used with $\frac{1}{2}$ " Microphone Preamplifier Type 2669 and Adaptor UC 0211, the preamplifier's inherent noise dominates (see [Table 7.4](#)).

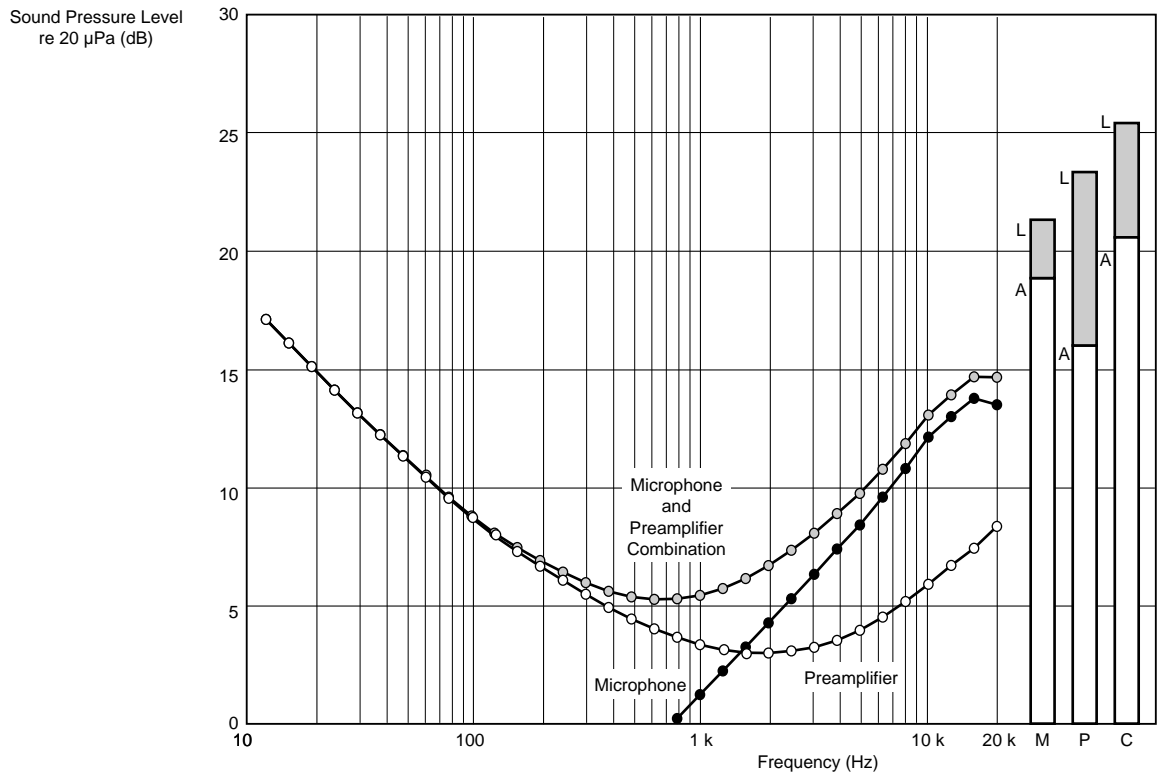

940720e

Fig. 7.16 1/3-octave-band inherent noise spectrum. The shaded bar graphs are the broadband (20Hz to 20kHz) noise levels and the white bar graphs the A-weighted noise levels of the microphone (M), 1/2" Microphone Preamplifier Type 2669 (P) and microphone and preamplifier combination (C). Valid for microphone without Adaptor UC 0211

Distortion

The distortion is determined mainly by the microphone but, at the highest operation levels, the preamplifier also contributes to the distortion (see Fig. 7.18 and Fig. 7.18).

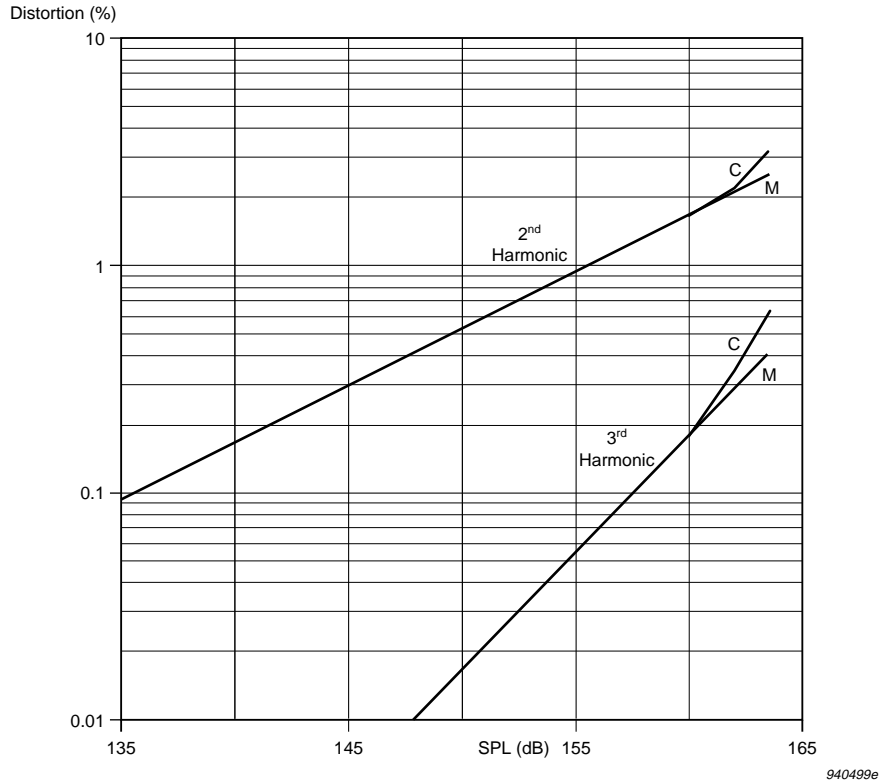

Fig. 7.17 Typical distortion characteristics of the microphone with $\frac{1}{2}$ " Microphone Preamplifier Type 2669 (C) and unloaded (M)

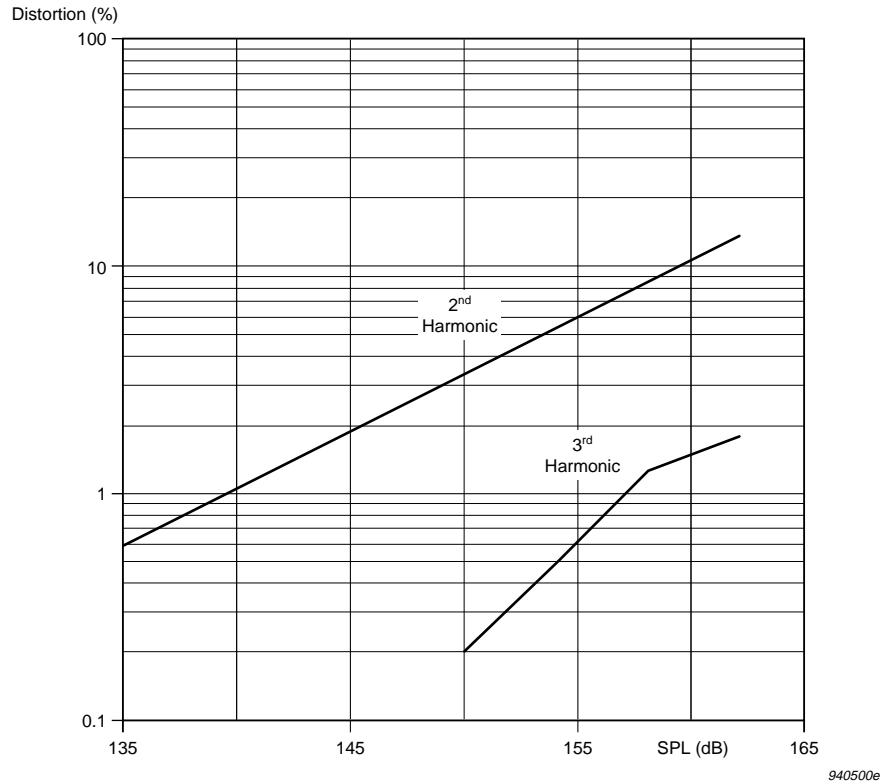

Fig. 7.18 Typical distortion characteristics of the microphone fitted with Adaptor UC 0211 and $\frac{1}{2}$ " Microphone Preamplifier Type 2669

The distortion is dependent on the capacitance parallel to the microphone. It increases with increasing capacitance. The distortions given in [Table 7.3](#) to [Table 7.4](#) are valid for a parallel capacitance of 0.5 pF. The distortion is measured at 100 Hz but can be assumed to be valid up to approximately 5 kHz (that is, where the diaphragm displacement is predominantly stiffness-controlled). Distortion measurement methods for higher frequencies are not available.

Lower Limit				Upper Limit	
1 Hz bandwidth at 1 kHz (dB)	$\frac{1}{3}$ -octave band at 1 kHz (dB)	A-weighted (dB)	Linear 20 Hz to 20 kHz (dB)	< 3% distortion (dB)	Max. SPL (Peak) (dB)
-22.4	1.2	19.0	21.3	162	171

Table 7.3 Dynamic range of the microphone

Lower Limit				Upper Limit	
1 Hz bandwidth at 1 kHz (dB)	$\frac{1}{3}$ -octave band at 1 kHz (dB)	A-weighted (dB)	Linear 20 Hz to 20 kHz (dB)	< 3% distortion (dB)	Max. SPL (Peak) (dB)
-18.2	5.4	20.7	25.4	161	166

Table 7.4 Dynamic range of the microphone with $\frac{1}{2}$ " Microphone Preamplifier Type 2669

Lower Limit				Upper Limit	
1 Hz bandwidth at 1 kHz (dB)	$\frac{1}{3}$ -octave band at 1 kHz (dB)	A-weighted (dB)	Linear 1 Hz to 20 kHz (dB)	< 3% distortion (dB)	Max. SPL (Peak) (dB)
-9.9	13.7	29.0	38.2	148	168

Table 7.5 Dynamic range of the microphone with $\frac{1}{2}$ " Microphone Preamplifier Type 2669 and Adaptor UC0211

Maximum Sound Pressure Level

In general, the microphone should not be exposed to sound pressure levels which produce voltages higher than the maximum input voltage specified for the connected preamplifier. After an overload, the preamplifier needs time to recover and, during this recovery period, you cannot measure validly. The maximum input voltage for most Brüel & Kjær preamplifiers is ± 50 V (with a 130 V supply). This voltage is produced by a nominal Low-frequency Pressure-field $\frac{1}{2}$ " Microphone Type 4193 at a Peak level of 166 dB (re $20 \mu\text{Pa}$).

The microphone will maintain its charge up to a Peak level of 171 dB (re $20 \mu\text{Pa}$). Above this level, the diaphragm and back plate short-circuit. If this occurs, the microphone needs one or two minutes to recharge before it is ready to measure validly. We recommend not to expose Low-frequency Pressure-field $\frac{1}{2}$ " Microphone Type 4193 to levels higher than 171 dB (Peak).

7.6 Equivalent Volume and Calibrator Load Volume

Equivalent Volume

For some applications it is practical to express the acoustic impedance of the microphone diaphragm in terms of a complex equivalent volume. This makes it easier to evaluate the effect of microphone loading on closed cavities or acoustic calibration couplers.

The real and imaginary parts of the equivalent volume shown in Fig.7.19 are in parallel. They are calculated from a simple R-L-C series model of the microphone which gives the best overall approximation of the microphone's diaphragm impedance.

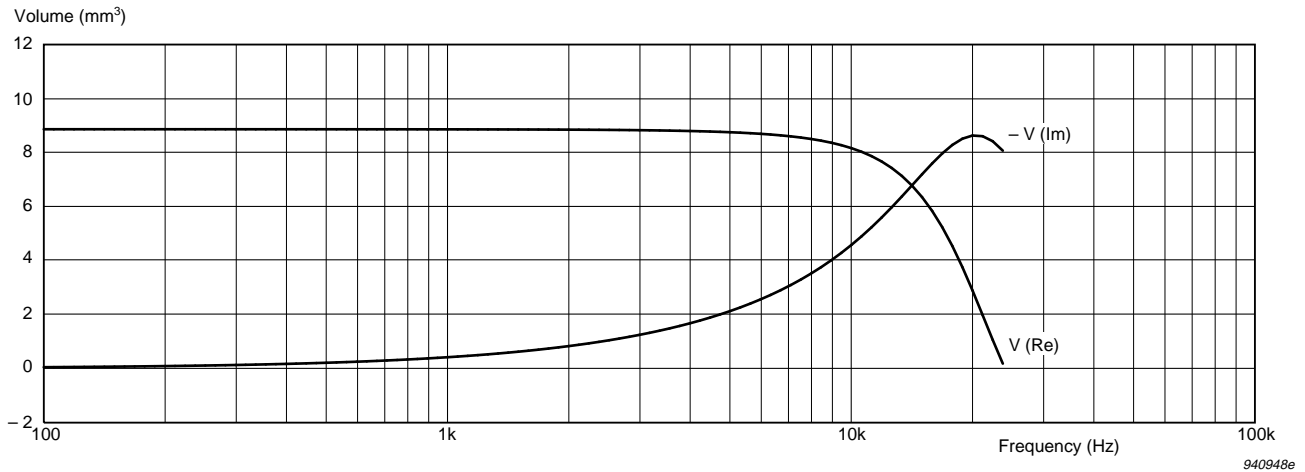

Fig.7.19 Typical equivalent volume (real and imaginary parts) based on mathematical model of microphone

The Models

The following equivalent models are valid at 101.325 kPa, 23 °C and 50%RH:

Model 1

$$C = 0.062 \times 10^{-12} \text{ m}^5/\text{N}$$

$$L = 710 \text{ kg/m}^4$$

$$R = 119 \times 10^6 \text{ Ns/m}^5$$

where C = acoustic diaphragm compliance
 L = acoustic diaphragm mass
 R = acoustic diaphragm damping resistance

Model 2

$$V_{lf} = 8.8 \text{ mm}^3$$

$$f_0 = 24 \text{ kHz}$$

$$Q = 0.9$$

where V_{lf} = low-frequency volume
 f_0 = diaphragm resonance frequency
 Q = quality factor

Calibrator Load Volume

When the microphone with its protection grid is inserted into the coupler of a calibrator, it will load the calibrator by a volume of 190 mm³ at 250 Hz.

Load volume correction to Pistonphone Type 4228 Calibration Level (with Adaptor DP 0776): +0.02 dB

7.7 Capacitance

The microphone's impedance is determined by its polarized capacitance. In addition, the preamplifier's input resistance and capacitance load the microphone. This loading determines the electrical lower limiting frequency and the capacitive input attenuation. However, with modern preamplifiers, this loading is very small and is included in the preamplifier gain, G (see [section 7.2.2](#)). Only in special cases with high capacitive loading does the fall in capacitance with frequency have to be taken into account.

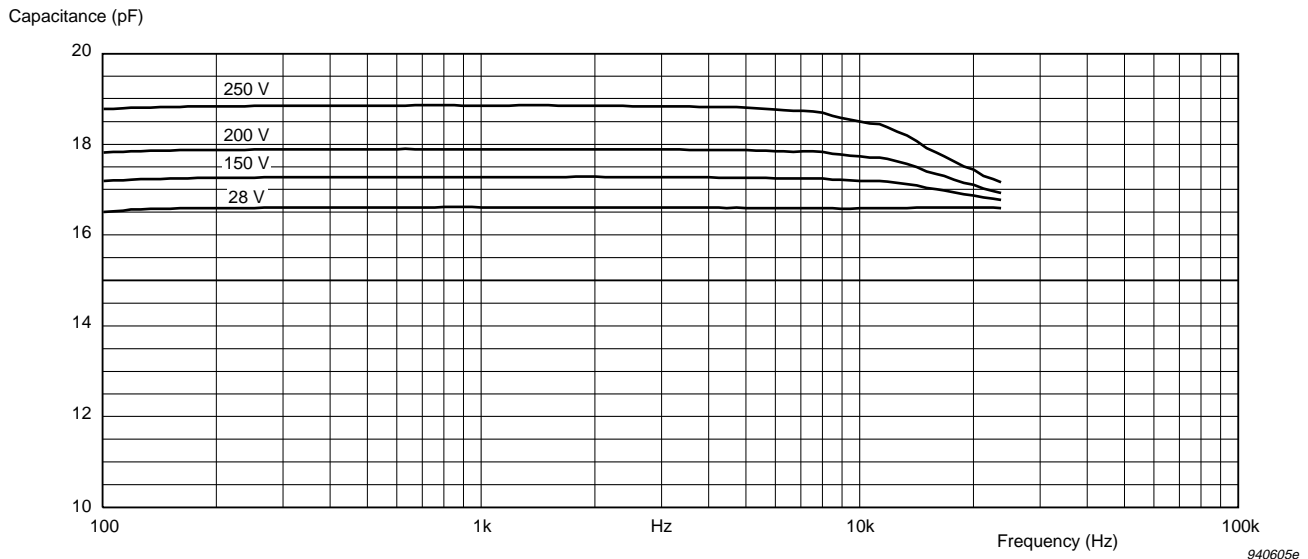

Fig. 7.20 Variation of capacitance with polarization voltage and frequency

Typical capacitance (at 250 Hz): 18 pF

The capacitance is individually calibrated and stated on the calibration chart.

7.8 Polarization Voltage

Generally, a microphone is operated at its nominal polarization voltage. For Low-frequency Pressure-field 1/2" Microphone Type 4193, this is 200 V. As this polariza-

tion voltage is positive, the output voltage is negative for a positive pressure applied to the diaphragm.

In special cases where there is a risk of preamplifier overload or there are long cables to be driven, choose a lower voltage. This will cause a lower sensitivity (see Fig. 7.21) and a change in the frequency response (see Fig. 7.22).

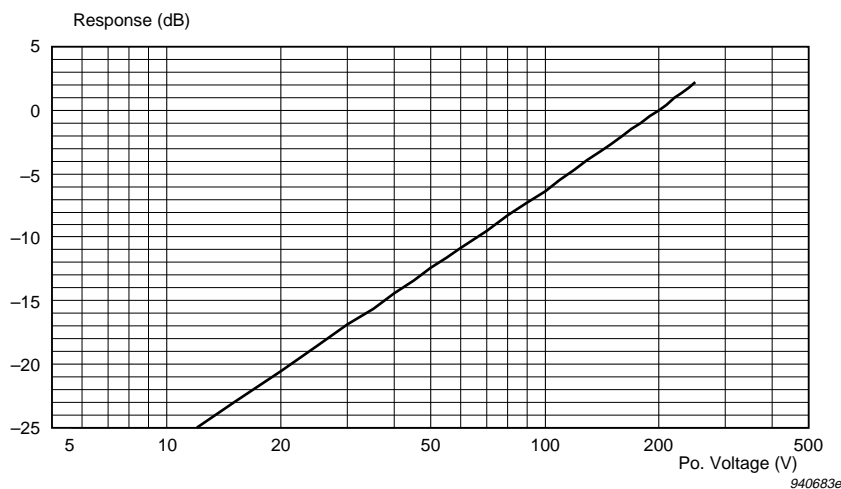

Fig. 7.21 Variation in sensitivity (at 250 Hz) as a function of polarization voltage, relative to the sensitivity with a polarization voltage of 200 V

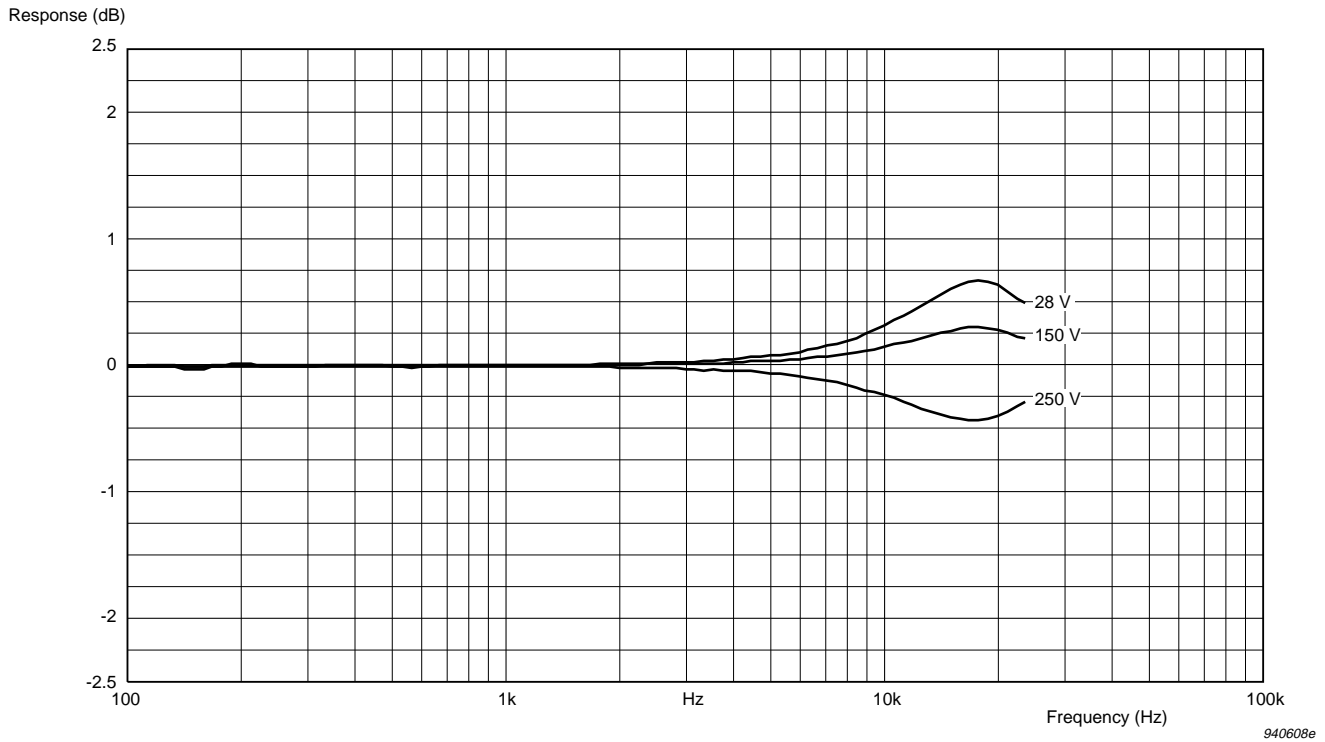

Fig. 7.22 Effect of polarization voltage on frequency response. The curves show the difference from the response with a polarization voltage of 200 V (normalised at 250 Hz)

7.9 Leakage Resistance

To maintain the correct polarization voltage on the microphone, the microphone's leakage resistance must be at least 1000 times greater than the supply resistance of the polarization charge, even under the most severe environmental conditions. This resistance which is generally placed in the preamplifier, is typically 10^9 to $10^{10} \Omega$. Brüel & Kjær microphones have a very high leakage resistance which is greater than $5 \times 10^{15} \Omega$ at 90%RH and 23°C.

7.10 Stability

7.10.1 Mechanical Stability

The microphone's design with respect to mechanical stability is improved compared with traditional Brüel & Kjær microphones. The diaphragm clamping ring is less sensitive to accidental force and the protection grid is significantly reinforced. Therefore, the microphone can withstand mechanical shocks better than traditional Brüel & Kjær microphones.

The sensitivity change of the microphone is less than 0.1 dB after a free fall of 1 m onto a solid hardwood block (re IEC 68-2-32).

This improved mechanical stability makes Low-frequency Pressure-field $\frac{1}{2}$ " Microphone Type 4193 well-suited for surface mounting and for mounting in small couplers as no mechanical adaptor is required to protect the diaphragm clamping ring. The microphone can be supported by the diaphragm clamping ring directly on the coupler's surface. Any force of less than 5 Newtons will cause a change in sensitivity of less than 0.005 dB. This makes the microphone well-suited for fitting in small, plane wave couplers used for reciprocity calibration and any other small coupler with a well-defined volume.

7.10.2 High-temperature Stability

The diaphragm is made of a stainless steel alloy. The alloy has been carefully selected and is very resistant to heat. This means that the diaphragm tension (and therefore the sensitivity) remain the same, even after several hours' operation at high temperature.

The microphone has been tested at temperatures up to 300°C. Below 170°C, no changes occur. At 170°C, the sensitivity can be permanently changed within the first 10 hours by less than 0.025 dB. After this, the sensitivity can be permanently changed within the next 100 hours by a similar value. At 300°C, the sensitivity can be permanently changed within the first hour by +0.4 dB. After this, the sensitivity can be permanently changed within the next 10 hours by less than +0.4 dB.

Note: Special adaptors (inserted between the microphone and preamplifier) must be made for high-temperature applications in order to protect the preamplifier from heat conduction and radiation.

7.10.3 Long-term Stability

Over a period of time, the mechanical tension in the diaphragm will decrease due to stretching within the foil. This mechanism, which, in principle, causes an increased sensitivity, is, however, very weak for the microphone. Measurement of this mechanism is not possible at room temperature.

At present, no exact value can be given for the microphone's long-term stability but measured changes at high temperatures indicate that Low-frequency Pressure-field $\frac{1}{2}$ " Microphone Type 4193 is more than 10 times more stable than traditional Brüel & Kjær microphones. This indicates typical changes of less than 1 dB in 5000 years.

7.11 Effect of Temperature

By careful selection of materials, optimization of the design and artificial ageing, the effect of temperature has been made to be very low.

The microphone has been designed to operate at temperatures from -30 to 300°C . When the microphone is subjected to temperatures above 200°C , it may be discoloured but its functionality will remain unaffected. See [section 7.10.2](#) for permanent changes in sensitivity at temperatures above 170°C .

The reversible changes are shown in [Fig.7.23](#) as a change in sensitivity and in [Fig.7.26](#) to [Fig.7.26](#) as changes in the frequency response normalized at 250 Hz.

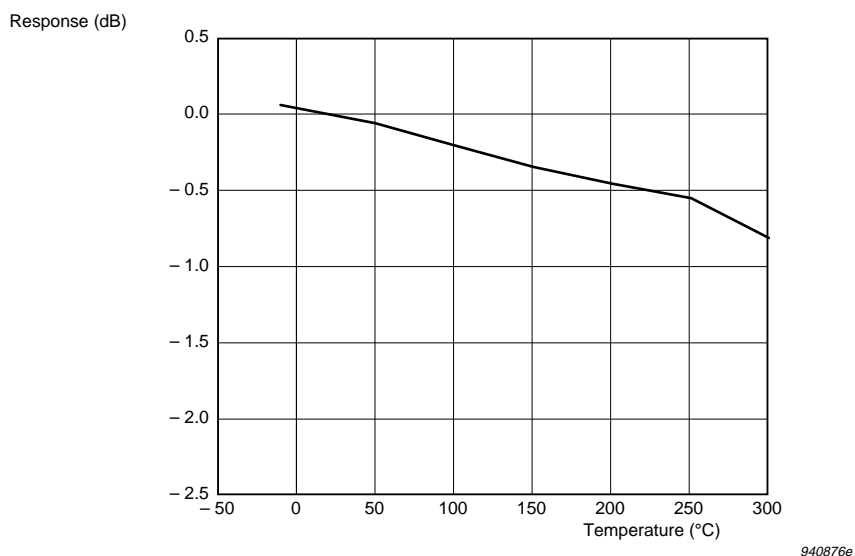

Fig.7.23 Typical variation in sensitivity (at 250 Hz) as a function of temperature, relative to the sensitivity at 20°C

Temperature Coefficient (250 Hz):

-0.002 dB/ $^{\circ}\text{C}$, typical (for the range -10 to $+50^{\circ}\text{C}$)

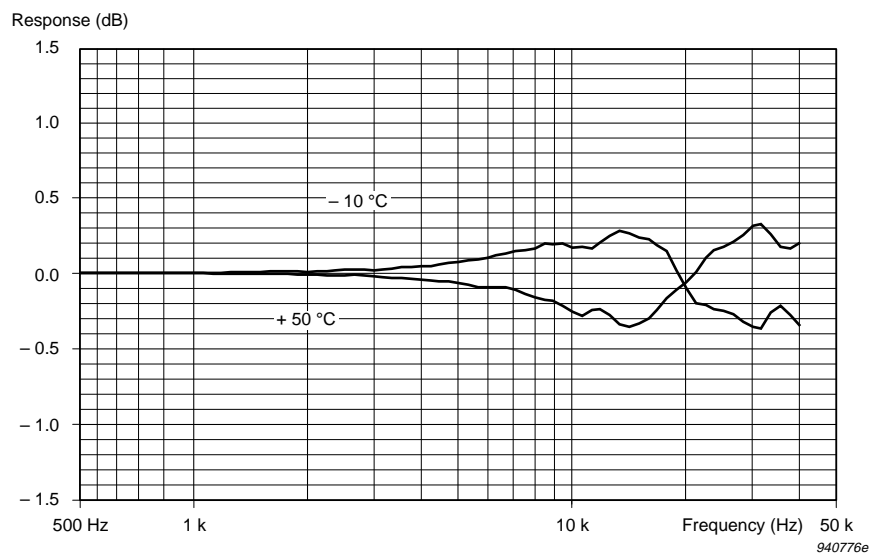

Fig. 7.24 Typical variation in actuator response (normalized at 250 Hz) as a function of temperature, relative to the response at 20°C (see Fig. 7.4) over the temperature range defined by IEC 651

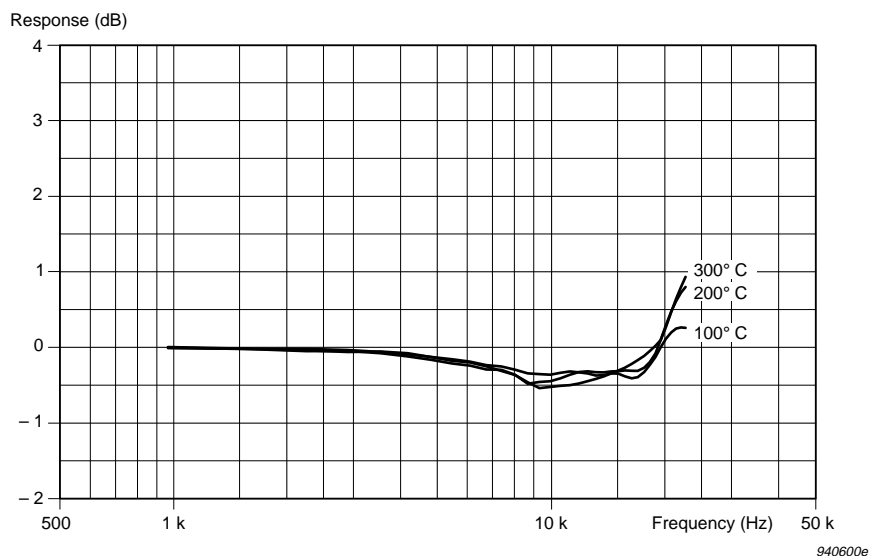

Fig. 7.25 Typical variation in actuator response (normalized at 250 Hz) as a function of temperature, relative to the response at 20°C (see Fig. 7.4)

The effect of temperature on the free-field response (see Fig. 7.26) of the microphone is the sum of the following effects:

- the calculated effect of the change in the speed of sound due to temperature on the 0° -incidence free-field correction
- the measured change in the actuator response due to temperature (see Fig. 7.24).

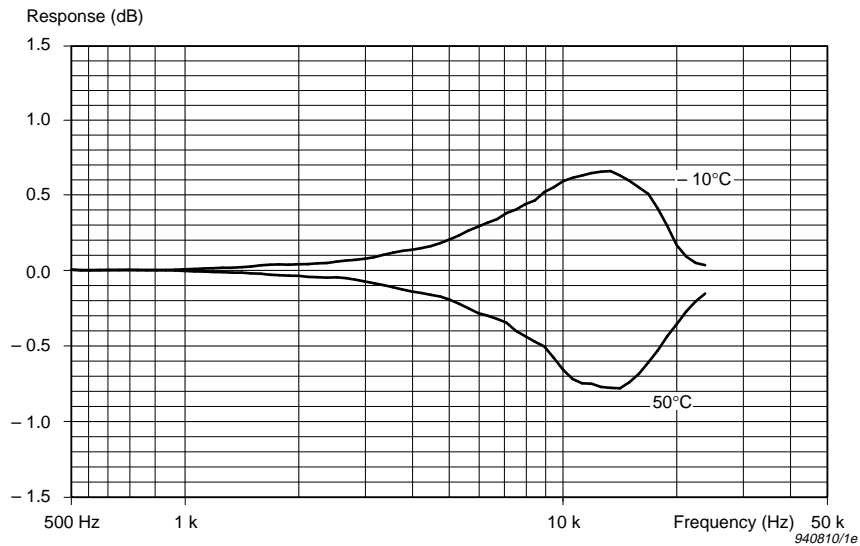

Fig. 7.26 Typical variation in 0° -incidence free-field response with Protection Grid DB 3421 (normalized at 250 Hz) as a function of temperature, relative to the response at 20°C (see Fig. 7.7) over the temperature range defined by IEC 651

7.12 Effect of Ambient Pressure

The microphone's sensitivity and frequency response are affected by variations in the ambient pressure. This is due to changes in air stiffness in the cavity behind the diaphragm, and changes in air mass in the small gap between the diaphragm and the back plate. The effects are shown in Fig. 7.27 to Fig. 7.29.

The typical pressure coefficient at 250 Hz for Low-frequency Pressure-field $\frac{1}{2}$ " Microphone Type 4193 is -0.005 dB/kPa.

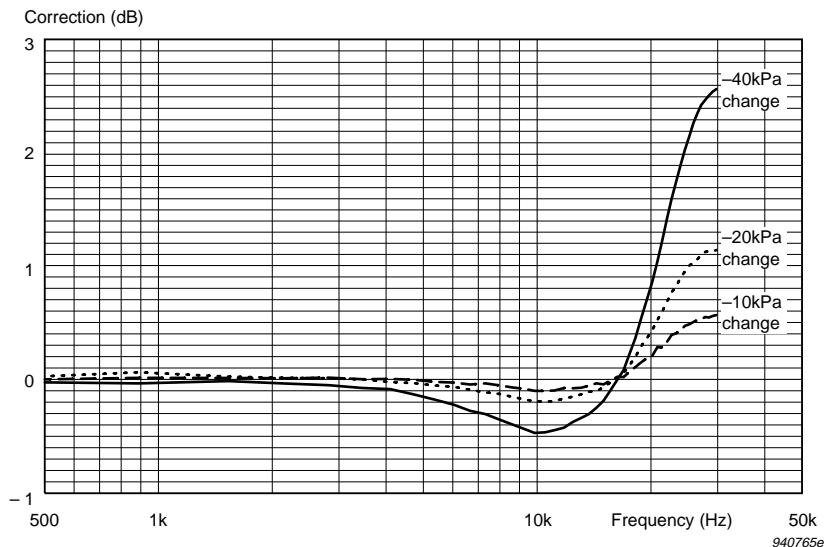

Fig. 7.27 Typical variation in frequency response (normalized at 250 Hz) from that at 101.3 kPa as a function of change in ambient pressure

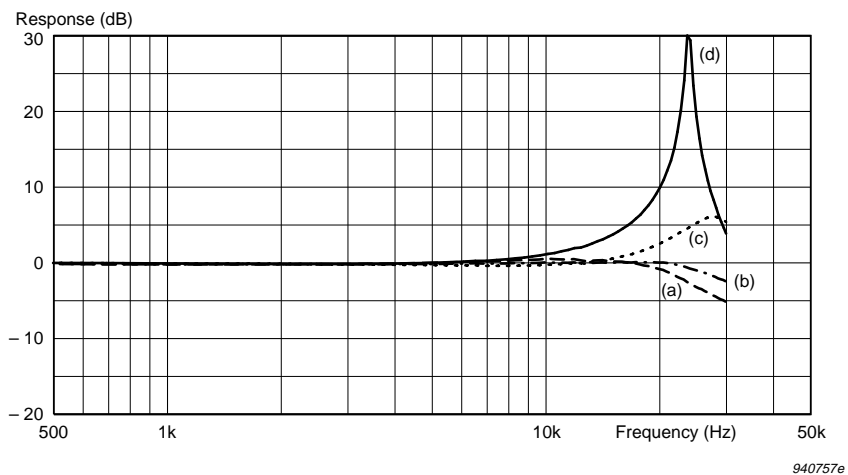

Fig. 7.28 Typical effect of ambient pressure on actuator response (a) at 101.3 kPa (b) -40 kPa change (c) -80 kPa change (d) at 2 kPa

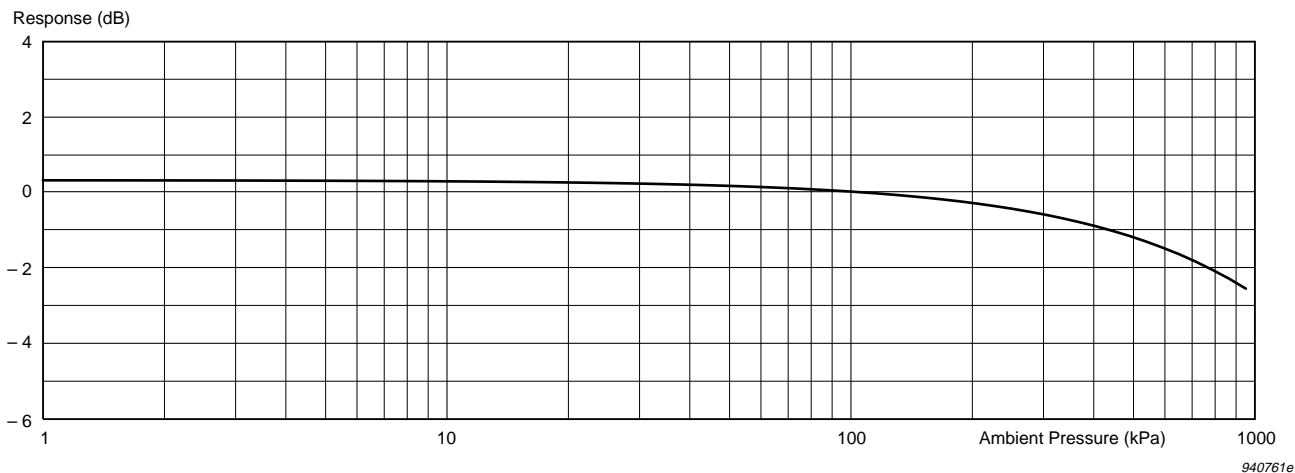

Fig 7.29 Typical variation in sensitivity at 250Hz from that at 101.3kPa as a function of ambient pressure

7.13 Effect of Humidity

Due to the microphone's high leakage resistance, humidity has, in general, no effect on the microphone's sensitivity or frequency response. The microphone has been tested according to IEC 68-2-3 and the effects of humidity on the sensitivity at 250 Hz and the frequency response have been found to be less than 0.1 dB at up to 95% RH (non-condensing) and 40°C.

7.14 Effect of Vibration

The effect of vibration is determined mainly by the mass of the diaphragm and is at its maximum for vibrations applied normal to the diaphragm. A vibration signal of 1 m/s^2 RMS normal to the diaphragm typically produces an equivalent Sound Pressure Level of 65.5 dB for a microphone fitted with Protection Grid DB 3421.

7.15 Effect of Magnetic Field

The effect of a magnetic field is determined by the vector field strength and is normally at its maximum when the field direction is normal to the diaphragm. A magnetic field strength of 80 A/m at 50 Hz (the test level recommended by IEC and ANSI) normal to the diaphragm produces a typical equivalent Sound Pressure Level of 16 dB. Higher frequency components in the microphone output become dominant at field strengths greater than 500 to 1000 A/m.

7.16 Electromagnetic Compatibility

See [Chapter 8](#).

7.17 Specifications Overview

7.17.1 Low-frequency Pressure Response $\frac{1}{2}$ " Microphone Type 4193

<p>OPEN-CIRCUIT SENSITIVITY (250 Hz)*: –38 dB \pm1.5 dB re 1 V/Pa, 12.5 mV/Pa*</p> <p>POLARIZATION VOLTAGE: External: 200 V</p> <p>FREQUENCY RESPONSE*: Pressure-field response: 0.12 Hz to 12.5 kHz \pm1 dB 0.07 Hz to 20 kHz \pm2 dB In accordance with ANSI S1.4 –1983, Type 1 and ANSI S1.12, Type M</p> <p>LOWER LIMITING FREQUENCY (–3 dB): 0.01 Hz to 0.05 Hz (vent exposed to sound)</p> <p>PRESSURE EQUALIZATION VENT: Side vented</p> <p>DIAPHRAGM RESONANCE FREQUENCY: 23 kHz, typical (90° phase shift)</p> <p>CAPACITANCE (POLARIZED)*: 18 pF, typical (at 250 Hz)</p> <p>EQUIVALENT AIR VOLUME (101.3 kPa): 8.8 mm³</p> <p>_____</p> <p>* Individually calibrated</p>	<p>CALIBRATOR LOAD VOLUME (250 Hz): 190 mm³</p> <p>PISTONPHONE TYPE 4228 CORRECTION: with DP 0776: +0.02 dB</p> <p>TYPICAL CARTRIDGE THERMAL NOISE: 19.0 dB (A) 21.3 dB (Lin.)</p> <p>UPPER LIMIT OF DYNAMIC RANGE: 3% distortion: >162 dB SPL</p> <p>MAXIMUM SOUND PRESSURE LEVEL: 171 dB (peak)</p> <p>OPERATING TEMPERATURE RANGE: –30 to +150°C (–22 to 302°F) (can be used up to +300°C (572°F) but with a permanent sensitivity change of typically +0.4 dB which stabilises after one hour)</p> <p>OPERATING HUMIDITY RANGE: 0 to 100% RH (without condensation)</p> <p>STORAGE TEMPERATURE: –30 to +70°C (–22 to 158°F)</p> <p>TEMPERATURE COEFFICIENT (250 Hz): –0.002 dB/°C, typical (for the range –10 to +50°C)</p>	<p>PRESSURE COEFFICIENT (250 Hz): –0.005 dB/kPa, typical</p> <p>INFLUENCE OF HUMIDITY: >1 000 years/dB at 20°C <0.001 dB/100%RH</p> <p>VIBRATION SENSITIVITY (<1000 Hz): Typically 65.5 dB equivalent SPL for 1 m/s² axial acceleration</p> <p>MAGNETIC FIELD SENSITIVITY: Typically 16 dB SPL for 80 A/m, 50 Hz field</p> <p>ESTIMATED LONG-TERM STABILITY: >1 00 hours/dB at 150°C</p> <p>DIMENSIONS: Diameter: 13.2 mm (0.52 in) (with grid) 12.7 mm (0.50 in) (without grid) Height: 13.5 mm (0.54 in) (with grid) 12.6 mm (0.50 in) (without grid) Thread for preamplifier mounting: 11.7 mm – 60 UNS</p> <p>The data above are valid at 23°C, 101.3 kPa and 50%RH, unless otherwise specified.</p>
--	--	--

7.17.2 Adaptor UC 0211

<p>LOWER CUT-OFF FREQUENCY: 0.1 Hz (with $\frac{1}{2}$" Microphone Preamplifier Type 2669)</p> <p>EFFECT ON HIGH FREQUENCY RESPONSE: 100 Hz to 10 kHz \pm0.1 dB 100 Hz to 20 kHz \pm0.5 dB</p>	<p>ATTENUATION: 16 dB</p> <p>CAPACITANCE: 100 pF, typical</p>	<p>DIMENSIONS: Diameter: 12.7 mm (0.50 in) Height: 14.1 mm (0.56 in) Thread for preamplifier and microphone mounting: 11.7 mm – 60 UNS</p>
---	---	---

7.18 Ordering Information

Preamplifier

Type 2669: $\frac{1}{2}$ " Microphone Preamplifier

Calibration Equipment

Type 4231: Sound Level Calibrator

Type 4226: Multifunction Acoustic Calibrator

Type 4228: Pistonphone

UA 0033: Electrostatic Actuator

Other Accessories

UA 0254: Set of 6 Windscreens (UA 0237) 90 mm (3.5 in)

UA 0469: Set of 6 Windscreens (UA 0459) 65 mm (2.6 in)

Chapter 8

1/2" Microphone Preamplifier Type 2669

8.1 Introduction

8.1.1 Description

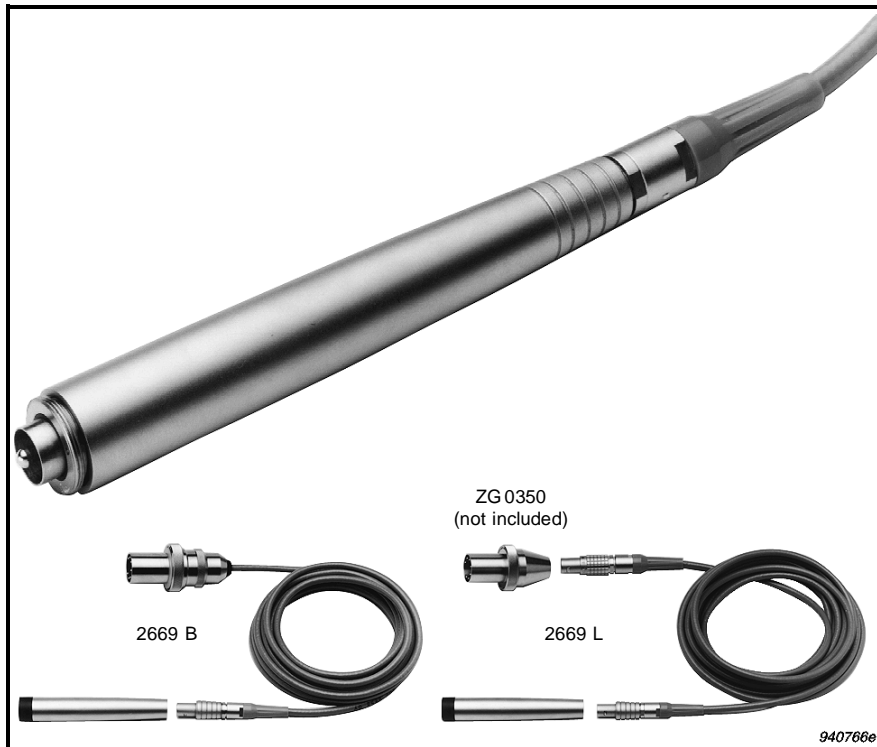

Fig 8.1 $\frac{1}{2}$ " Microphone Preamplifier Type 2669 B and 2669 L shown with LEMO to 7-pin Brüel & Kjær Adaptor ZG 0350 (not included)

$\frac{1}{2}$ " Microphone Preamplifier Type 2669 is a general-purpose microphone preamplifier which includes the following features:

- Built-in calibration facility for testing the complete measurement set-up
- Thin and flexible cable with wide, working temperature range
- High output current capability
- Works with both dual and single power supplies
- Fulfils electromagnetic compatibility (EMC) requirements EN 50081-1 and pr EN 50081-2

The preamplifier is available in two versions, the 2669 L and the 2669 B. The only difference is the connector at the instrument end for the preamplifier socket. The 2669 L is supplied with a detachable cable with a LEMO connector. The 2669 B is supplied with a detachable cable with a Brüel & Kjær connector. The preamplifier can be stored in the supplied case with a microphone mounted when not in use.

Alternatively, the preamplifier can be stored in the microphone's case with the microphone when not in use.

8.1.2 Connections

Pin No.	Connection	
	LEMO (2669 L)	Brüel & Kjær (2669 B)
1	Calibration Input	Ground
2	Signal Ground	Polarization Voltage
3	Polarization Voltage	Calibration Input
4	Signal Output	Signal Output
5	Not connected	Power Supply Positive
6	Power Supply Positive	Not connected
7	Power Supply Negative/Ground	Not connected
Casing	Connected to instrument chassis	

2669 L

2669 B

Cable's output plug seen from outside 940478/1e

Table 8.1 Pin designations

8.1.3 Physical Dimensions

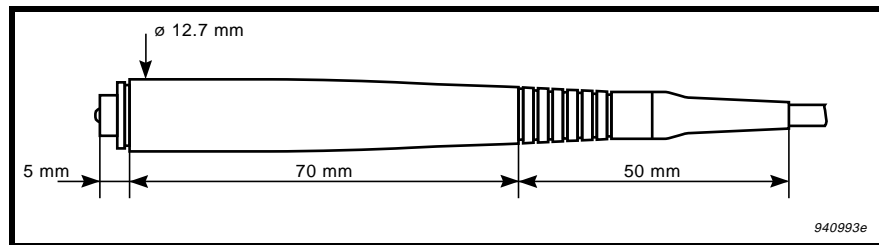
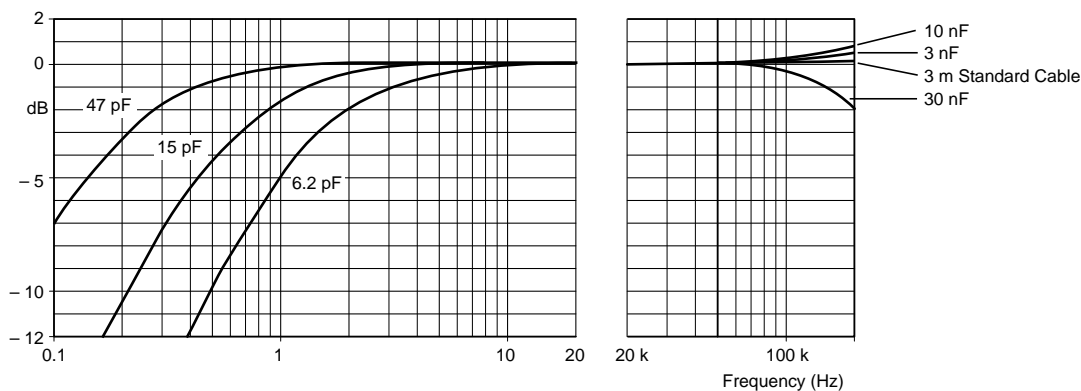

Fig 8.2 Physical dimensions of the preamplifier and connector

8.2 Frequency Response

The frequency response of the preamplifier depends on the capacitance of the microphone connected to its input, and the capacitive load (for example, extension cables) connected to the output.



941021e

Fig 8.3 Typical frequency response as a function of input (transducer) capacitance at low frequencies and as a function of capacitive loading at high frequencies

The low frequency curves in [Fig.8.3](#) show the low-frequency response of the preamplifier for various capacitances typical of 1", 1/2" and 1/4" microphones. Note, they do not show the lower cut-off frequencies of the microphones.

The effects of various capacitive output loads (cables etc.) on the high frequencies are also shown. All curves shown in [Fig.8.3](#) apply only for low signal levels where the limitations shown in [Fig.8.5](#) and [Fig.8.6](#) have no influence.

8.3 Dynamic Range

Overview:

Lower limit with 15 pF microphone (μV)	Upper limit ($\pm 60\text{ V}$ supply, $f < 10\text{ kHz}$) ^a	Dynamic Range (dB)
A-weighted: 2.2	50 V _P	147
Lin. (20 Hz to 300 kHz): 10.0		134

Table 8.2 Nominal open-circuit sensitivity

a. See Fig. 8.6 for upper limit at higher frequencies

Inherent Noise:

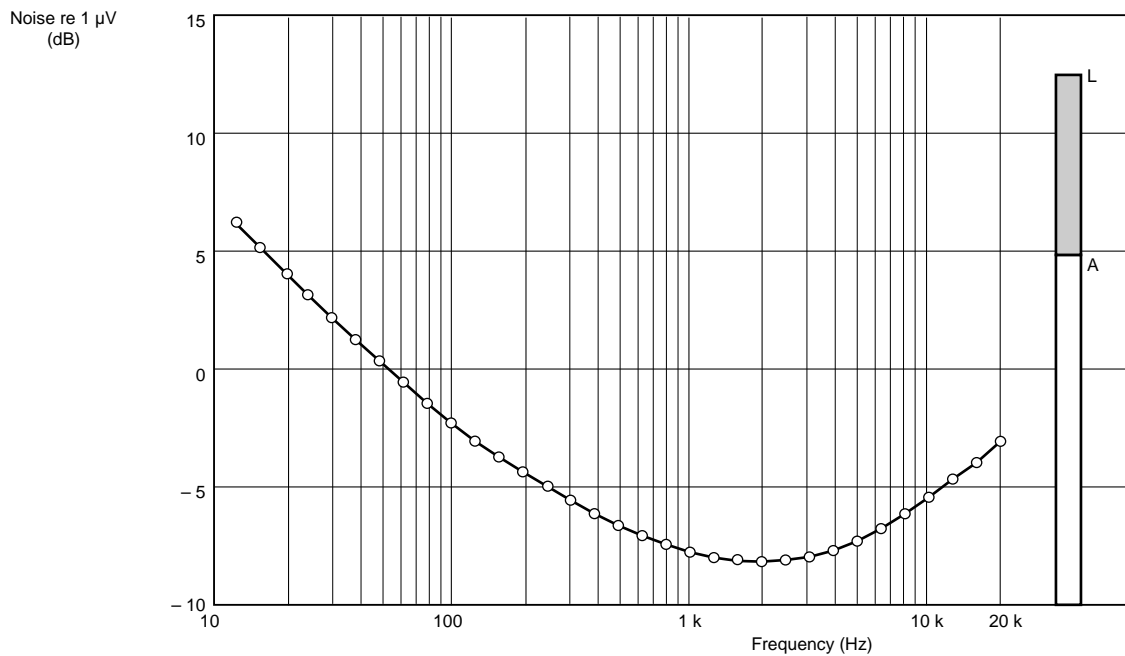

940882e

Fig. 8.4 Typical 1/3-octave-band inherent noise spectrum measured with a 15 pF dummy microphone. The shaded bar graph is the broad-band (20 Hz to 20 kHz) noise level and the white bar graph the A-weighted noise level. The circles represent levels at 1/3-octave-band centre frequencies

Distortion:

Distortion (THD): <-80 dB (1000 Hz, 25 V output, 3 m cable)

Maximum Output:

The maximum output of the preamplifier depends on the capacitive load (for example, extension cables) connected to the output. If the specified maximum output current of the preamplifier is exceeded, the signal will be distorted.

Fig.8.5 and Fig.8.6 show the distortion-limited output when the preamplifier is used with different power supplies.

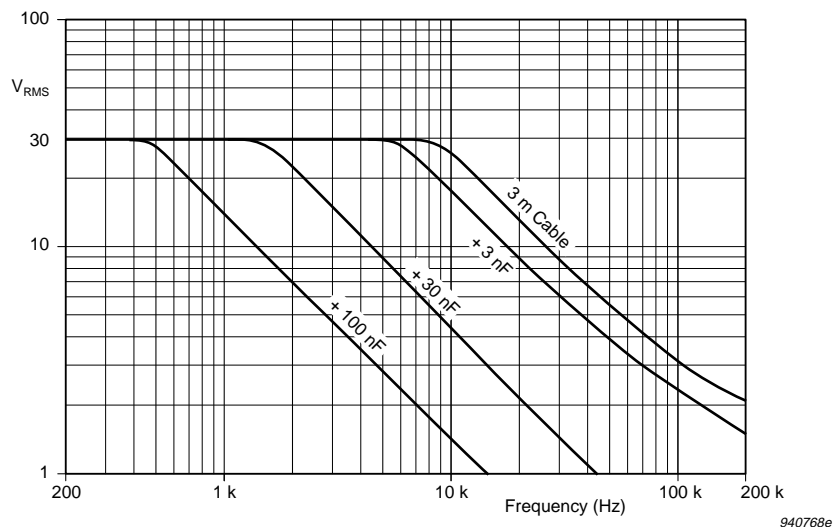

Fig 8.5 Upper limit of dynamic range (3% distortion) of preamplifier (powered by traditional Brüel & Kjær power supplies) due to capacitive loading as a function of frequency. Note: These power supplies limit the maximum output current

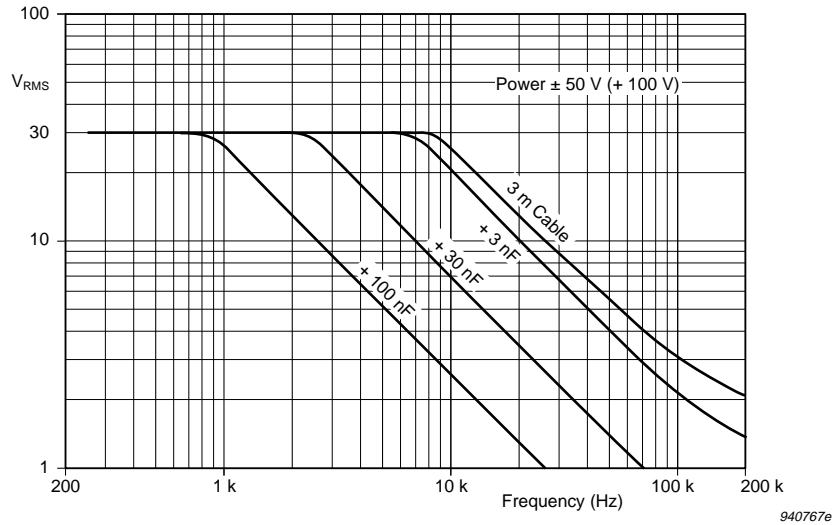

Fig. 8.6 Upper limit of dynamic range (3% distortion) of preamplifier (with a ± 50 V DC supply voltage) due to capacitive loading as a function of frequency

Fig. 8.7 shows the distortion limited output for three different voltage supplies, in each case when the preamplifier is loaded by the 3 m cable normally supplied with the preamplifier.

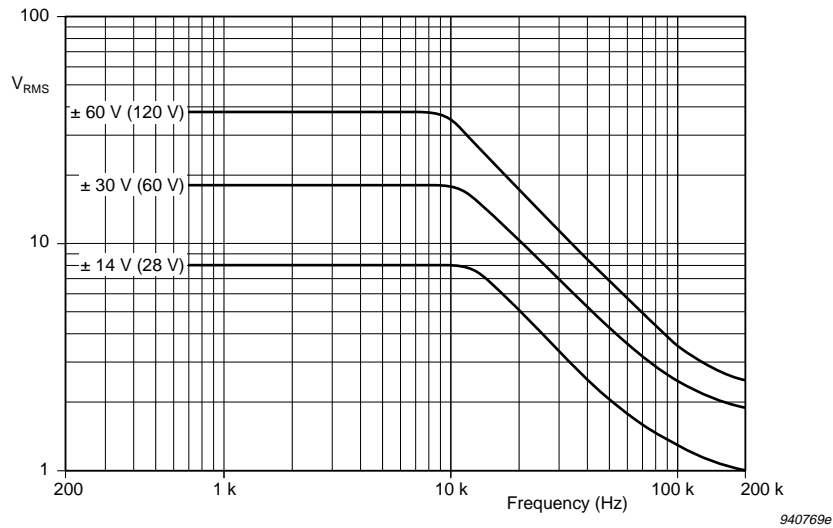

Fig. 8.7 Maximum output voltage as a function of supply voltage and frequency

8.4 Phase Response

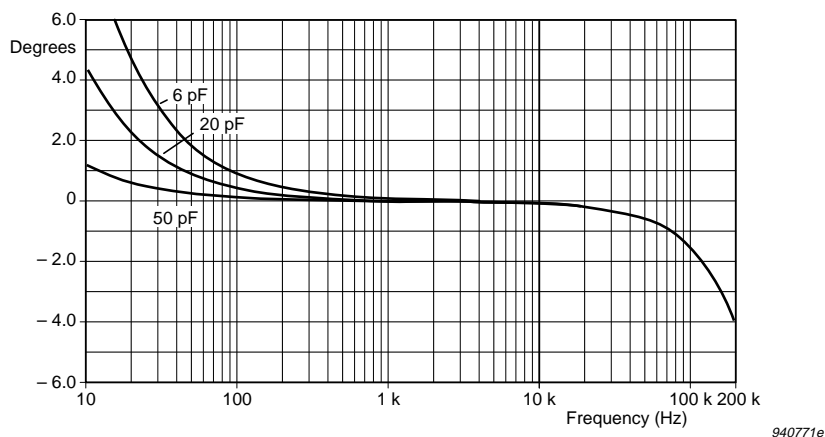

Fig.8.8 Phase response as a function of input (transducer) capacitance (measured with the 3m cable normally supplied with the preamplifier)

8.5 Effect of Temperature

As the temperature increases, the bias current in the the input amplifier increases. This causes the inherent noise to increase and the input impedance to decrease resulting in the effect shown in Fig.8.9.

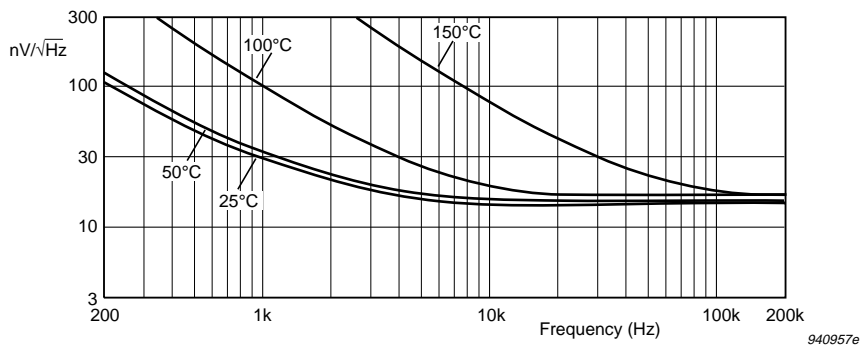

Fig.8.9 Effect of temperature on inherent noise

Note: The preamplifier can withstand temperatures up to 150°C. However, we do not recommend that it is exposed to this temperature over a longer period of time as the product's life expectancy is drastically reduced. In addition, we recommend that you don't use high supply voltages with long cables at this temperature for the same reason.

8.6 Effect of Magnetic Fields

Typically $<3\ \mu\text{V}$ for 80 A/m at 50 Hz

8.7 Electromagnetic Compatibility (EMC)

1/2" Microphone Preamplifier Type 2669 is constructed such that it is extremely resistant to external electromagnetic radiation. This is important when measuring near such things as radar and radio transmitters (for example, mobile telephones).

An important prerequisite for achieving this immunity is that connected instrumentation also fulfil these requirements and that the preamplifier's termination in the measuring instrument is correctly constructed (see Fig. 8.10). Brüel & Kjær equipment which are designed for connection with 1/2" Microphone Preamplifier Type 2669L and the supplied extension cable fulfil the requirements for immunity to external electromagnetic radiation.

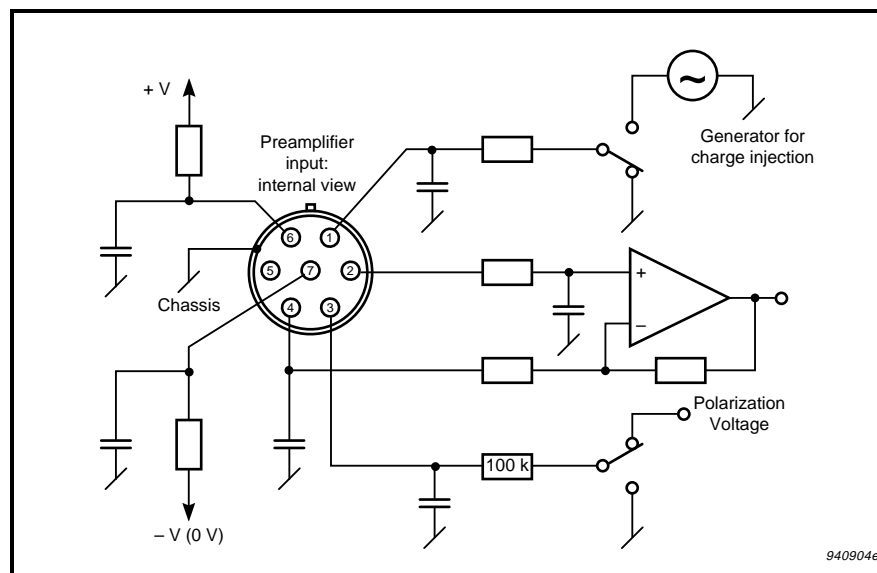

Fig. 8.10 Simplified electronic construction of input circuit of 1/2" Microphone Preamplifier Type 2669 for ensuring compliance with EMC requirements

Note: Brüel & Kjær equipment, typically those having the traditional Brüel & Kjær microphone socket, do not fulfil these strict immunity requirements.

1/2" Microphone Preamplifier Type 2669 conforms to EMC requirements EN 50081-1 and pr EN 50081-2 when connected to an instrument that also conforms to these regulations.

8.8 Brüel & Kjær's Patented Charge-injection Calibration Technique

This is a new patented technique for verifying the entire measurement set-up including the microphone, the preamplifier and the connecting cable (see Fig. 8.11).

The Charge-injection Calibration (CIC) technique is a method for remotely verifying the condition of the entire measurement set-up **including the microphone**. This is a great improvement over the earlier insert-voltage calibration method which virtually ignores the state of the microphone. The CIC technique is very sensitive to any change in the microphone's capacitance which is a reliable indicator of the microphone's condition.

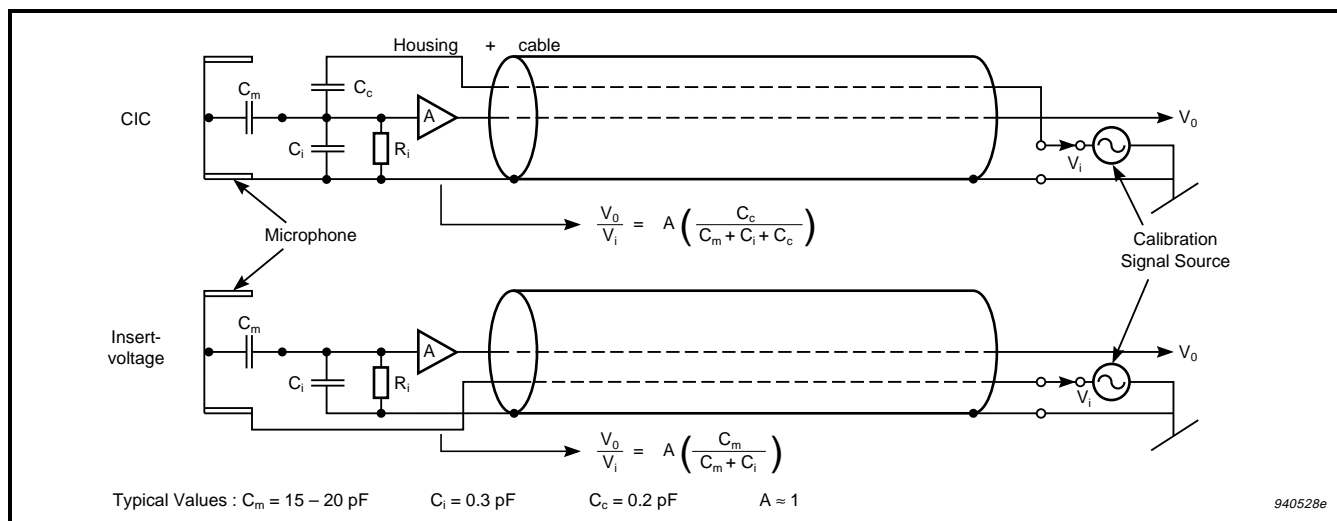

Fig. 8.11 Charge-injection calibration (CIC) technique compared to insert-voltage calibration technique

The technique works by introducing a small but accurately defined capacitance C_c (typically 0.2 pF) with a very high leakage resistance (greater than 50000 GΩ) into the circuit of the preamplifier, see Fig. 8.11 (upper diagram). C_i and R_i represent the preamplifier's high input impedance and A its gain (≈ 1).

For a given calibration signal, V_i , the output, V_o of this arrangement will change measurably, even for small changes in the microphone's capacitance, C_m . The CIC technique is about 100 times more sensitive than the insert-voltage calibration arrangement shown in Fig. 8.11 (lower diagram).

In the extreme case where there is significant leakage between the microphone's diaphragm and its backplate (C_m becomes very large), the signal output will change by tens of decibels compared with only tenths of a decibel using the insert-voltage method.

Another important CIC feature is that, unlike the insert-voltage technique, it is far less sensitive to external electrical fields.

8.9 Specifications Overview

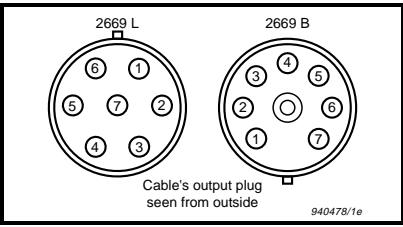
<p>FREQUENCY RESPONSE (re. 1 kHz): 3 Hz to 200 kHz, ± 0.5 dB ATTENUATION: 0.25 dB (typical) PHASE LINEARITY: $\leq \pm 3^\circ$ at 20 Hz to 100 kHz PHASE MATCHING: 0.3° at 50 Hz INPUT IMPEDANCE: $15\text{ G}\Omega \parallel 0.45\text{ pF}$ OUTPUT IMPEDANCE: 25 Ω MAX. OUTPUT CURRENT: 20 mA (peak) Note: The max. output current can be limited by the power supply. MAX. OUTPUT VOLTAGE: Total supply voltage -10 V ($V_{\text{peak peak}}$) OUTPUT SLEW RATE: $2\text{ V}/\mu\text{s}$ DISTORTION (THD): Less than -80 dB at 25 V out, 1 kHz NOISE (15 pF DUMMY): $\leq 10.0\text{ }\mu\text{V}$ Lin. 20 Hz – 300 kHz $\leq 2.2\text{ }\mu\text{V}$ A weighted POWER SUPPLY, DUAL: $\pm 14\text{ V}$ to $\pm 60\text{ V}$ POWER SUPPLY, SINGLE: 28 V to 120 V OUTPUT DC OFFSET: $\approx 1\text{ V}$ for a dual supply, or $\approx 1/2$ the voltage of a single supply</p>	<p>CURRENT CONSUMPTION: 3 mA plus output current CALIBRATION INPUT: Charge insert capacity, typically 0.2 pF Max. 10 V_{RMS}, input impedance: 1 nF ENVIRONMENTAL: Conforms to EMC requirements EN50081–1 and prEN50081–2 when connected to an instrument that also conforms to these regulations Note: the above are valid for a 15 pF mic. (1/2") and a 3 metre cable CONNECTOR TYPE: LEMO type FGJ.OB.307 at preamplifier LEMO type FGG.1B.307 (2669 L), or Brüel & Kjær JP 0715 (2669 B) to measuring device</p> <p>PIN CONNECTIONS:</p>  <p>DIMENSIONS: $\varnothing 12.7\text{ mm} \times 110\text{ mm}$ (including connector)</p>	<table border="1"> <thead> <tr> <th>Pin</th> <th>LEMO (L)</th> <th>Brüel & Kjær (B)</th> </tr> </thead> <tbody> <tr> <td>1</td> <td>Calibration input</td> <td>Ground</td> </tr> <tr> <td>2</td> <td>Signal ground</td> <td>Pol. voltage</td> </tr> <tr> <td>3</td> <td>Pol. voltage</td> <td>Calibration input</td> </tr> <tr> <td>4</td> <td>Signal output</td> <td>Signal output</td> </tr> <tr> <td>5</td> <td>Not connected</td> <td>Power supply positive</td> </tr> <tr> <td>6</td> <td>Power supply positive</td> <td>Not connected</td> </tr> <tr> <td>7</td> <td>Power supply negative/ground</td> <td>Not connected</td> </tr> <tr> <td>Casing</td> <td colspan="2">Connected to instrument chassis</td> </tr> </tbody> </table> <p>TEMPERATURE RANGE: -20 to 60°C 150°C with increase in noise HUMIDITY: Up to 90% RH, non condensing</p>	Pin	LEMO (L)	Brüel & Kjær (B)	1	Calibration input	Ground	2	Signal ground	Pol. voltage	3	Pol. voltage	Calibration input	4	Signal output	Signal output	5	Not connected	Power supply positive	6	Power supply positive	Not connected	7	Power supply negative/ground	Not connected	Casing	Connected to instrument chassis	
Pin	LEMO (L)	Brüel & Kjær (B)																											
1	Calibration input	Ground																											
2	Signal ground	Pol. voltage																											
3	Pol. voltage	Calibration input																											
4	Signal output	Signal output																											
5	Not connected	Power supply positive																											
6	Power supply positive	Not connected																											
7	Power supply negative/ground	Not connected																											
Casing	Connected to instrument chassis																												

8.10 Ordering Information

Extension Cables

LEMO — LEMO:

AO 0414 Extension Cable 3 m (9.8 ft.)

AO 0415 Extension Cable 10 m (32.8 ft.)

AO 0416 Extension Cable 30 m (98.4 ft.)

EL 4004/xx Extension Cable length xx m (specified by customer)

Brüel & Kjær — Brüel & Kjær:

AO 0027 Extension Cable 3 m (9.8 ft.)

AO 0028 Extension Cable 10 m (32.8 ft.)

AO 0029 Extension Cable 30 m (98.4 ft.)

Microphone Adaptors

DB 0375 Adaptor for 1" microphone

UA 0035 Adaptor for $\frac{1}{4}$ " microphone

UA 0036 Adaptor for $\frac{1}{8}$ " microphone

Other Accessories

ZG 0350 LEMO to 7-pin Brüel & Kjær adaptor

JJ 2617 Coaxial Input Adaptor for direct connection to input cables

UA 0196 Flexible Extension Rod

UA 1284 Stand

UA 1317 Microphone Holder

Chapter 9

Accessories

9.1 Accessories Available

9.1.1 Microphone Accessories

Accessory	Prepolarized Free-field Microphone Type 4188	Prepolarized Free-field Microphone Type 4189	Free-field Precision Microphone Type 4190	Free-field Microphone Type 4191	Pressure Microphone Type 4192	Low-frequency Pressure Microphone Type 4193
Windscreen UA 0237, UA 0459	•	•	•	•	•	•
Rain Cover UA 0393	•	•	•	•	•	•
Nose Cone UA 0386	•	•	•	•	•	•
Dehumidifier UA 0308	•	•	•			
Turbulence Screen UA 036	•	•	•	•		

Table 9.1 Accessories available for the various microphones

9.1.2 Cables and Adaptors

Cable/Adaptor	Description	Notes
AO 0149	LEMO–LEMO cable (3 m)	Included with Preamplifier Type 2669 L
AO 0428	LEMO–Brüel & Kjær cable (3 m)	Included with Preamplifier Type 2669 B
ZG 0350	LEMO–Brüel & Kjær adaptor	
AO 0414	LEMO–LEMO extension cable (3 m)	
AO 0415	LEMO–LEMO extension cable (10 m)	
AO 0416	LEMO–LEMO extension cable (30 m)	
AR 0014	LEMO-LEMO flat cable (0.5 m)	

Table 9.2 Cables and adaptors available from Brüel & Kjær

Index

- 1/2" Microphone Preamplifier Type 2669 8-1
 - 2669, 1/2" Microphone Preamplifier 8-1
 - 4188
 - Prepolarized Free-field 1/2" Microphone 2-1
 - 4189
 - Prepolarized Free-field 1/2" Microphone 3-1
 - 4190
 - Free-field 1/2" Microphone 4-1
 - 4191
 - Free-field 1/2" Microphone 5-1
 - 4192
 - Pressure-field 1/2" Microphone 6-1
 - 4193
 - Low-frequency Pressure-field 1/2" Microphone 7-1
 - 4190, free-field microphone 4-7
 - 4191, free-field microphone 5-7
 - 4192, pressure-field microphone 6-7
 - 4193, pressure-field microphone 7-9
 - Adaptor 9-2
 - LEMO-Brüel & Kjær 9-2
 - microphone 8-12
 - UC 0211 7-5
 - Ambient pressure
 - 4188, prepolarized microphone 2-25
 - 4189, prepolarized microphone 3-25
 - 4190, free-field microphone 4-25
 - 4191, free-field microphone 5-25
 - 4192, pressure-field microphone 6-25
 - 4193, pressure-field microphone 7-28
- A**
- About the Microphone Handbook 1-2
 - Accessories 8-12, 9-1
 - 4188, prepolarized microphone 2-29
 - 4189, prepolarized microphone 3-29
 - 4190, free-field microphone 4-29
 - 4191, free-field microphone 5-29
 - 4192, pressure-field microphone 6-29
 - 4193, pressure-field microphone 7-32
 - microphone 9-2
 - Actuator frequency response
 - 4188, prepolarized microphone 2-6
 - 4189, prepolarized microphone 3-7
- C**
- Cable 9-2
 - extension 8-11, 9-2
 - LEMO-Brüel & Kjær 9-2
 - LEMO-LEMO 9-2
 - Calibration
 - charge-injection 8-10
 - CIC 8-10
 - interval
 - 4188, prepolarized microphone 2-4
 - 4189, prepolarized microphone 3-5
 - 4190, free-field microphone 4-5
 - 4191, free-field microphone 5-5

- 4192, pressure-field microphone 6-5
- 4193, pressure-field microphone 7-5
- Calibration chart
 - 4188, prepolarized microphone 2-3
 - 4189, prepolarized microphone 3-3
 - 4190, free-field microphone 4-3
 - 4191, free-field microphone 5-3
 - 4192, pressure-field microphone 6-3
 - 4193, pressure-field microphone 7-3
- Calibration equipment
 - 4188, prepolarized microphone 2-28
 - 4189, prepolarized microphone 3-28
 - 4190, free-field microphone 4-28
 - 4191, free-field microphone 5-28
 - 4192, pressure-field microphone 6-28
 - 4193, pressure-field microphone 7-32
- Calibrator load volume
 - 4188, prepolarized microphone 2-19
 - 4189, prepolarized microphone 3-19
 - 4190, free-field microphone 4-18
 - 4191, free-field microphone 5-18
 - 4192, pressure-field microphone 6-18
 - 4193, pressure-field microphone 7-22
- Capacitance
 - 4188, prepolarized microphone 2-20
 - 4189, prepolarized microphone 3-20
 - 4190, free-field microphone 4-19
 - 4191, free-field microphone 5-19
 - 4192, pressure-field microphone 6-19
 - 4193, pressure-field microphone 7-22
- Charge-injection calibration 8-10
- CIC 8-10
- Connections, Preamplifier Type 2669 8-3

D

- Data disk
 - 4189, prepolarized microphone 3-4
 - 4190, free-field microphone 4-4
 - 4191, free-field microphone 5-4
 - 4192, pressure-field microphone 6-4
 - 4193, pressure-field microphone 7-4
- Dehumidifier 9-2
- Description
 - 4188, prepolarized microphone 2-2
 - 4189, prepolarized microphone 3-2
 - 4190, free-field microphone 4-2
 - 4191, free-field microphone 5-2
 - 4192, pressure-field microphone 6-2
 - 4193, pressure-field microphone 7-2

- Dimensions, Preamplifier Type 2669 8-3
- Directional characteristics
 - 4188, prepolarized microphone 2-13
 - 4189, prepolarized microphone 3-14
 - 4190, free-field microphone 4-13
 - 4191, free-field microphone 5-13
 - 4192, pressure-field microphone 6-13
 - 4193, pressure-field microphone 7-15
- Discolouration
 - 4190, free-field microphone 4-22
 - 4191, free-field microphone 5-22
 - 4192, pressure-field microphone 6-22
 - 4193, pressure-field microphone 7-26
- Disk data
 - 4189, prepolarized microphone 3-4
 - 4190, free-field microphone 4-4
 - 4191, free-field microphone 5-4
 - 4192, pressure-field microphone 6-4
 - 4193, pressure-field microphone 7-4
- Distortion
 - 2669, preamplifier 8-6
 - 4188, prepolarized microphone 2-18
 - 4189, prepolarized microphone 3-17
 - 4190, free-field microphone 4-16
 - 4191, free-field microphone 5-16
 - 4192, pressure-field microphone 6-16
 - 4193, pressure-field microphone 7-18
- Dynamic range
 - 2669, preamplifier 8-5
 - 4188, prepolarized microphone 2-16
 - 4189, prepolarized microphone 3-15
 - 4190, free-field microphone 4-14
 - 4191, free-field microphone 5-14
 - 4192, pressure-field microphone 6-14
 - 4193, pressure-field microphone 7-16

E

- Electromagnetic compatibility 8-9
- EMC 8-9
- Equivalent volume
 - 4188, prepolarized microphone 2-19
 - 4189, prepolarized microphone 3-18
 - 4190, free-field microphone 4-17
 - 4191, free-field microphone 5-17
 - 4192, pressure-field microphone 6-17
 - 4193, pressure-field microphone 7-20
- Extension cable 8-11, 9-2

F

Free-field 1/2" Microphone Type 4190 4-1

Free-field 1/2" Microphone Type 4191 5-1

Free-field frequency response

4188, prepolarized microphone 2-8

4189, prepolarized microphone 3-9

4190, free-field microphone 4-9

4191, free-field microphone 5-9

4192, pressure-field microphone 6-9

4193, pressure-field microphone 7-10

Frequency response

2669, preamplifier 8-4

actuator

4188, prepolarized microphone 2-6

4189, prepolarized microphone 3-7

4190, free-field microphone 4-7

4191, free-field microphone 5-7

4192, pressure-field microphone 6-7

4193, pressure-field microphone 7-9

free-field

4188, prepolarized microphone 2-8

4189, prepolarized microphone 3-9

4190, free-field microphone 4-9

4191, free-field microphone 5-9

4192, pressure-field microphone 6-9

4193, pressure-field microphone 7-10

low-frequency

4188, prepolarized microphone 2-7

4189, prepolarized microphone 3-8

4190, free-field microphone 4-8

4191, free-field microphone 5-8

4192, pressure-field microphone 6-8

4193, pressure-field microphone 7-10

optimized

4188, prepolarized microphone 2-6

4189, prepolarized microphone 3-7

4190, free-field microphone 4-7

4191, free-field microphone 5-7

4192, pressure-field microphone 6-7

4193, pressure-field microphone 7-7

pressure-field

4189, prepolarized microphone 3-13

4190, free-field microphone 4-12

4191, free-field microphone 5-12

4192, pressure-field microphone 6-12

4193, pressure-field microphone 7-14

random-incidence

4188, prepolarized microphone 2-12

4189, prepolarized microphone 3-12

4190, free-field microphone 4-11

4191, free-field microphone 5-11

4192, pressure-field microphone 6-11

4193, pressure-field microphone 7-13

resolution

4188, prepolarized microphone 2-6

4189, prepolarized microphone 3-4, 3-7

4190, free-field microphone 4-4, 4-7

4191, free-field microphone 5-4, 5-7

4192, pressure-field microphone 6-4, 6-7

4193, pressure-field microphone 7-4, 7-7

H

Humidity

4188, prepolarized microphone 2-26

4189, prepolarized microphone 3-26

4190, free-field microphone 4-27

4191, free-field microphone 5-27

4192, pressure-field microphone 6-27

4193, pressure-field microphone 7-30

I

Inherent noise 5-15, 8-5

4188, prepolarized microphone 2-16

4189, prepolarized microphone 3-15

4190, free-field microphone 4-14

4191, free-field microphone 5-14

4192, pressure-field microphone 6-14

4193, pressure-field microphone 7-16

K

K-factor

4188, prepolarized microphone 2-5

4189, prepolarized microphone 3-6

4190, free-field microphone 4-6

4191, free-field microphone 5-6

4192, pressure-field microphone 6-6

4193, pressure-field microphone 7-6

L

Leakage resistance

4188, prepolarized microphone 2-21

4189, prepolarized microphone 3-21

4190, free-field microphone 4-21

4191, free-field microphone 5-21

4192, pressure-field microphone 6-21
4193, pressure-field microphone 7-24
LEMO-Brüel & Kjær adaptor 9-2
LEMO-Brüel & Kjær cable 9-2
LEMO-LEMO cable 9-2
LEMO-LEMO extension cable 9-2
Load volume, calibrator
4188, prepolarized microphone 2-19
4189, prepolarized microphone 3-19
4190, free-field microphone 4-18
4191, free-field microphone 5-18
4192, pressure-field microphone 6-18
4193, pressure-field microphone 7-22
Loaded sensitivity
4188, prepolarized microphone 2-4
4189, prepolarized microphone 3-5
4190, free-field microphone 4-5
4191, free-field microphone 5-5
4192, pressure-field microphone 6-5
4193, pressure-field microphone 7-6
Long-term stability
4188, prepolarized microphone 2-22
4189, prepolarized microphone 3-22
4190, free-field microphone 4-22
4191, free-field microphone 5-22
4192, pressure-field microphone 6-22
4193, pressure-field microphone 7-25
Low-frequency Pressure-field 1/2" Microphone
Type 4193 7-1
Low-frequency response
4188, prepolarized microphone 2-7
4189, prepolarized microphone 3-8
4190, free-field microphone 4-8
4191, free-field microphone 5-8
4192, pressure-field microphone 6-8
4193, pressure-field microphone 7-10

M
Magnetic field
2669, preamplifier 8-9
4188, prepolarized microphone 2-27
4189, prepolarized microphone 3-27
4190, free-field microphone 4-27
4191, free-field microphone 5-27
4192, pressure-field microphone 6-27
4193, pressure-field microphone 7-30
Maximum output
2669, preamplifier 8-6
Maximum Sound Pressure Level

4188, prepolarized microphone 2-18
4189, prepolarized microphone 3-17
4190, free-field microphone 4-16
4191, free-field microphone 5-16
4192, pressure-field microphone 6-16
4193, pressure-field microphone 7-20
Mechanical shock, stability
4188, prepolarized microphone 2-21
4189, prepolarized microphone 3-21
4190, free-field microphone 4-21
4191, free-field microphone 5-21
4192, pressure-field microphone 6-21
4193, pressure-field microphone 7-24
Microphone
accessories 9-2
adaptor 8-12
Microphone Preamplifier (1/2") Type 2669 8-1

N

Nose cone 9-2

O

Open-circuit sensitivity
4188, prepolarized microphone 2-4
4189, prepolarized microphone 3-5
4190, free-field microphone 4-5
4191, free-field microphone 5-5
4192, pressure-field microphone 6-5
4193, pressure-field microphone 7-5
Optimized frequency response
4188, prepolarized microphone 2-6
4189, prepolarized microphone 3-7
4190, free-field microphone 4-7
4191, free-field microphone 5-7
4192, pressure-field microphone 6-7
4193, pressure-field microphone 7-7
Ordering information
2669, preamplifier 8-11
4188, prepolarized microphone 2-28
4189, prepolarized microphone 3-28
4190, free-field microphone 4-28
4191, free-field microphone 5-28
4192, pressure-field microphone 6-28
4193, pressure-field microphone 7-32
Output
maximum
2669, preamplifier 8-6
Output voltage

- 4188, prepolarized microphone 2-2, 2-7,
2-20
- 4189, prepolarized microphone 3-2, 3-8,
3-20
- 4190, free-field microphone 4-8, 4-19
- 4191, free-field microphone 5-8, 5-19
- 4192, pressure-field microphone 6-8, 6-19
- 4193, pressure-field microphone 7-9, 7-23
- P**
- Phase response, Preamplifier Type 2669 8-8
- Physical dimensions
microphones 1-6
Preamplifier Type 2669 8-3
- Pin designations, Preamplifier Type 2669 8-3
- Polarization voltage
4188, prepolarized microphone 2-20
4189, prepolarized microphone 3-20
4190, free-field microphone 4-19
4191, free-field microphone 5-19
4192, pressure-field microphone 6-19
4193, pressure-field microphone 7-22
- Preamplifier
4188, prepolarized microphone 2-28
4189, prepolarized microphone 3-28
4190, free-field microphone 4-28
4191, free-field microphone 5-28
4192, pressure-field microphone 6-28
4193, pressure-field microphone 7-32
- Preamplifier (1/2" Microphone) Type 2669 8-1
connections 8-3
dimensions 8-3
distortion 8-6
dynamic range 8-5
electromagnetic compatibility 8-9
frequency response 8-4
magnetic field 8-9
maximum output 8-6
ordering information 8-11
phase response 8-8
physical dimensions 8-3
pin designations 8-3
specifications 8-11
temperature 8-8
- Prepolarized Free-field 1/2" Microphone Type
4188 2-1
- Prepolarized Free-field 1/2" Microphone Type
4189 3-1
- Pressure
ambient
4188, prepolarized microphone 2-25
4189, prepolarized microphone 3-25
4190, free-field microphone 4-25
4191, free-field microphone 5-25
4192, pressure-field microphone 6-25
4193, pressure-field microphone 7-28
- Pressure-field 1/2" Microphone Type 4192 6-1
- Pressure-field frequency response
4189, prepolarized microphone 3-13
4190, free-field microphone 4-12
4191, free-field microphone 5-12
4192, pressure-field microphone 6-12
4193, pressure-field microphone 7-14
- R**
- Rain cover 9-2
- Random-incidence frequency response
4188, prepolarized microphone 2-12
4189, prepolarized microphone 3-12
4190, free-field microphone 4-11
4191, free-field microphone 5-11
4192, pressure-field microphone 6-11
4193, pressure-field microphone 7-13
- Range, dynamic
4188, prepolarized microphone 2-16
4189, prepolarized microphone 3-15
4190, free-field microphone 4-14
4191, free-field microphone 5-14
4192, pressure-field microphone 6-14
4193, pressure-field microphone 7-16
- Recalibration
4188, prepolarized microphone 2-4
4189, prepolarized microphone 3-5
4190, free-field microphone 4-5
4191, free-field microphone 5-5
4192, pressure-field microphone 6-5
4193, pressure-field microphone 7-5
- Resistance
leakage
4188, prepolarized microphone 2-21
4189, prepolarized microphone 3-21
4190, free-field microphone 4-21
4191, free-field microphone 5-21
4192, pressure-field microphone 6-21
4193, pressure-field microphone 7-24
- Response, frequency
actuator
4188, prepolarized microphone 2-6

- 4189, prepolarized microphone 3-7
- 4190, free-field microphone 4-7
- 4191, free-field microphone 5-7
- 4192, pressure-field microphone 6-7
- 4193, pressure-field microphone 7-9
- free-field
 - 4188, prepolarized microphone 2-8
 - 4189, prepolarized microphone 3-9
 - 4190, free-field microphone 4-9
 - 4191, free-field microphone 5-9
 - 4192, pressure-field microphone 6-9
 - 4193, pressure-field microphone 7-10
- low-frequency
 - 4188, prepolarized microphone 2-7
 - 4189, prepolarized microphone 3-8
 - 4190, free-field microphone 4-8
 - 4191, free-field microphone 5-8
 - 4192, pressure-field microphone 6-8
 - 4193, pressure-field microphone 7-10
- optimized
 - 4188, prepolarized microphone 2-6
 - 4189, prepolarized microphone 3-7
 - 4190, free-field microphone 4-7
 - 4191, free-field microphone 5-7
 - 4192, pressure-field microphone 6-7
 - 4193, pressure-field microphone 7-7
- pressure-field
 - 4189, prepolarized microphone 3-13
 - 4190, free-field microphone 4-12
 - 4191, free-field microphone 5-12
 - 4192, pressure-field microphone 6-12
 - 4193, pressure-field microphone 7-14
- random-incidence
 - 4188, prepolarized microphone 2-12
 - 4189, prepolarized microphone 3-12
 - 4190, free-field microphone 4-11
 - 4191, free-field microphone 5-11
 - 4192, pressure-field microphone 6-11
 - 4193, pressure-field microphone 7-13
- resolution
 - 4188 prepolarized microphone 2-6
 - 4189 prepolarized microphone 3-4, 3-7
 - 4190 free-field microphone 4-4, 4-7
 - 4191 free-field microphone 5-4, 5-7
 - 4192 pressure-field microphone 6-4, 6-7
 - 4193 pressure-field microphone 7-4, 7-7

S

- Sensitivity
 - loaded
 - 4188, prepolarized microphone 2-4
 - 4189, prepolarized microphone 3-5
 - 4190, free-field microphone 4-5
 - 4191, free-field microphone 5-5
 - 4192, pressure-field microphone 6-5
 - 4193, pressure-field microphone 7-6
 - open-circuit
 - 4188, prepolarized microphone 2-4
 - 4189, prepolarized microphone 3-5
 - 4190, free-field microphone 4-5
 - 4191, free-field microphone 5-5
 - 4192, pressure-field microphone 6-5
 - 4193, pressure-field microphone 7-5
- Sound Pressure Level
 - maximum
 - 4188, prepolarized microphone 2-18
 - 4189, prepolarized microphone 3-17
 - 4190, free-field microphone 4-16
 - 4191, free-field microphone 5-16
 - 4192, pressure-field microphone 6-16
 - 4193, pressure-field microphone 7-20
- Specifications overview
 - 2669, preamplifier 8-11
 - 4188, prepolarized microphone 2-28
 - 4189, prepolarized microphone 3-28
 - 4190, free-field microphone 4-28
 - 4191, free-field microphone 5-28
 - 4192, pressure-field microphone 6-28
 - 4193, pressure-field microphone 7-31
- Stability
 - long-term
 - 4188, prepolarized microphone 2-22
 - 4189, prepolarized microphone 3-22
 - 4190, free-field microphone 4-22
 - 4191, free-field microphone 5-22
 - 4192, pressure-field microphone 6-22
 - 4193, pressure-field microphone 7-25
 - mechanical shock
 - 4188, prepolarized microphone 2-21
 - 4189, prepolarized microphone 3-21
 - 4190, free-field microphone 4-21
 - 4191, free-field microphone 5-21
 - 4192, pressure-field microphone 6-21
 - 4193, pressure-field microphone 7-24

T

Temperature

- 2669, preamplifier 8–8
- 4188, prepolarized microphone 2–22
- 4189, prepolarized microphone 3–22
- 4190, free-field microphone 4–22
- 4191, free-field microphone 5–22
- 4192, pressure-field microphone 6–22
- 4193, pressure-field microphone 7–26

Turbulence screen 9–2

V

Vibration

- 4188, prepolarized microphone 2–27
- 4189, prepolarized microphone 3–27
- 4190, free-field microphone 4–27
- 4191, free-field microphone 5–27
- 4192, pressure-field microphone 6–27
- 4193, pressure-field microphone 7–30

Volume

calibrator load

- 4188, prepolarized microphone 2–19
- 4189, prepolarized microphone 3–19
- 4190, free-field microphone 4–18
- 4191, free-field microphone 5–18
- 4192, pressure-field microphone 6–18
- 4193, pressure-field microphone 7–22

equivalent

- 4188, prepolarized microphone 2–19
- 4189, prepolarized microphone 3–18
- 4190, free-field microphone 4–17
- 4191, free-field microphone 5–17
- 4192, pressure-field microphone 6–17
- 4193, pressure-field microphone 7–20

W

Windscreens 9–2

