

Application Note

Time Domain Averaging Combined with Order Tracking

by N. Johan Wismer, Brüel & Kjær, Denmark

Apart from spectrum averaging, there is another averaging method that can be used when measuring periodic signals, namely synchronous time domain averaging. The main advantage of this method is that unwanted noise components are averaged out. On the 3550 analyzer, time domain averaging can be combined with order tracking analysis to yield a very powerful method for measuring on reciprocating engines (internal-combustion engines, pumps, and compressor).

Introduction

The most common method of acquiring frequency information is to use spectrum averaging, i.e. averaging is performed in the frequency domain. This method has a number of advantages, the principal one being that it is a very easy method to use, and that it will work with any type of signal.

But if you have some *a priori* knowledge about the signal under investigation, and if the signal of interest is periodic, then you can use the (synchronous) time domain averaging method, or signal enhancement as it is called on Brüel & Kjær analyzers. As opposed to frequency spectrum averaging, signal enhancement requires a trigger signal synchronous with the periodic signal of interest. Its principal advantage is that the signal components uncorrelated with the trigger signal average to zero as the number of averages goes to infinity. This is not the case when using spectrum averaging.

How does it work?

In the spectrum averaging method (Fig. 1), the Fourier transform is applied to blocks of time data, possibly

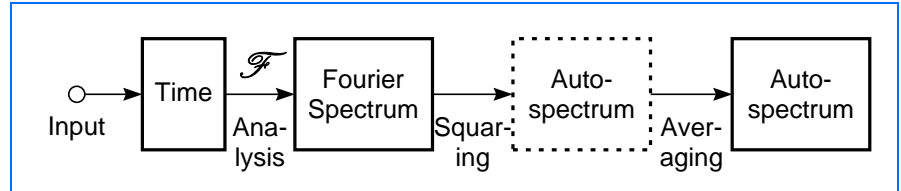

Fig. 1 The spectrum averaging method

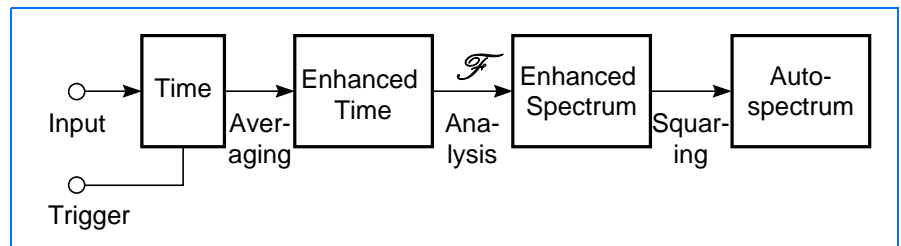

Fig. 2 The time domain averaging method

after a weighting function has been used (e.g. Hanning). The Fourier spectrum is then (complex) squared, to yield a real-valued spectrum called the Autospectrum (sometimes also referred to as Power Spectrum or Mean Square Spectrum). This function is averaged a number of times using one of the averaging modes: linear, exponential, etc.

Now if the time signal contains deterministic components, and if you can get a trigger signal synchronous with these components, then you can use the time domain averaging method (or signal enhancement). In this method, the time records are averaged together without any further processing (Fig. 2).

As a post-processing, an FFT can be applied to the averaged, possibly weighted, time signal, and this yields the Enhanced Spectrum. This is a complex valued function, and therefore contains phase information (relative to the trigger).

The autospectrum is equal to the magnitude squared of the enhanced spectrum.

How good is it?

For frequency domain averaging, the autospectrum is equal to:

$$G_{XX} = G_{AA} + G_{MM}$$

i.e. the autospectrum, G_{XX} , is equal to the deterministic component, G_{AA} , plus the noise component, G_{MM} . It does not matter how many times you average, the noise components will never go away.

For time domain averaging, the autospectrum is equal to:

$$G_{XX} = G_{AA} + 1/N_a \times G_{MM}^*$$

where G_{AA} is the deterministic component synchronous with the trigger signal, and G_{MM} is all the rest (uncorrelated noise). From this it follows that G_{MM} is reduced as the number of averages increase.

Every time the number of averages is increased tenfold, the noise component is reduced by 10 dB, i.e. Reduction = $10 \times \log(N_a)$.

* See Guided Tour number 3 in the User Manual for the Type 3550, Volume 1, for a detailed deduction of the formula

This is an important difference that you have to keep in mind. It is not always the case that you want to eliminate the random noise component of a signal. If you are making a measurement on an engine, and if you are interested in some rattle noise not necessarily correlated with the engine cycle, then time domain averaging will not work. If, on the other hand, you are interested in vibration related to the movement of the different components of the engine, and if you do not want random components to cloud the image, then time domain averaging might be the right answer.

In Fig. 3 you can see an example of spectrum averaging and a time domain averaging measurement. The signal was a 500 Hz square wave with some noise added to it.

You can see that the noise signal has (on the average) been lowered by 20 dB. The number of averages was 100, so Reduction = $10 \times \log(100) = 20$ dB.

Warning

When performing time domain averaging, there is, as stated earlier, a need for a trigger pulse to synchronize the records to be averaged. It is important that this trigger pulse is accurate, preferably with an accuracy equal to or better than the time between samples. An inaccurate trigger signal will ruin your time domain averaging measurement.

Where can it be used?

An obvious target for time domain averaging is measurements on rotating machinery (turbines, internal-combustion engines, pumps, etc.), or machinery that exhibit cyclic patterns (hydraulic or pneumatic equipment, presses, etc.).

Some of these are very stable, and the use of time domain averaging is unproblematic. Others are less stable, making the signal enhancement method a little more problematic. Changes in rotational speed while the measurement is going on will cause smearing of the time signal. This smearing can be eliminated by the use of order tracking.

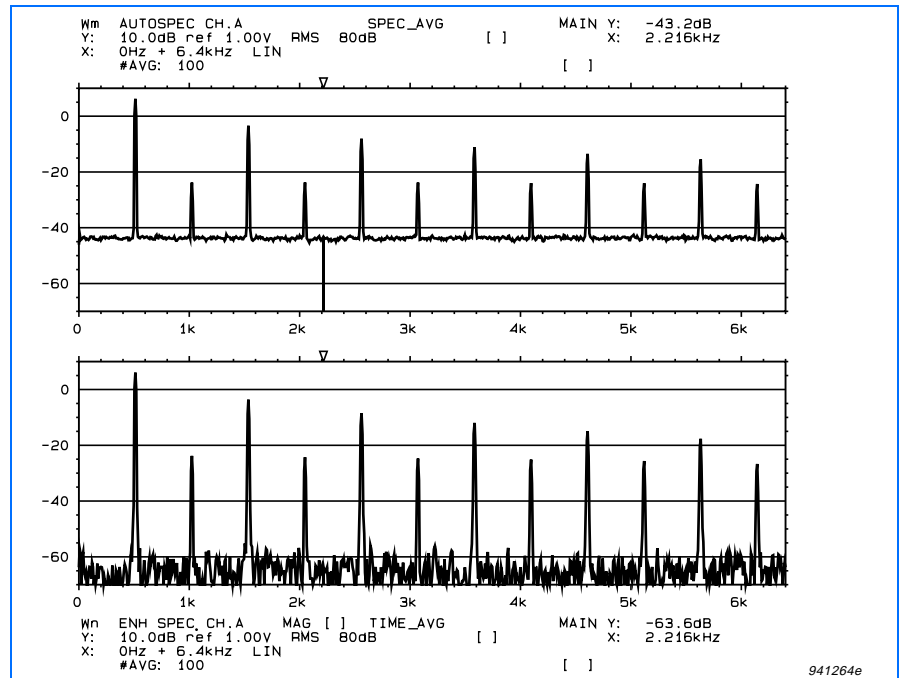

Fig.3 Spectrum averaging (top) and signal enhancement (bottom)

Combining Time Domain Averaging and Tracking

When measuring on rotating machinery, time domain averaging can often be combined with order tracking. The reasons for using order tracking are twofold. First, the rotational speed of many types of machinery is usually not extremely stable. Second, there are very often speed variations within one cycle, this variation can also change during the measurement.

Time domain averaging using order tracking can therefore be split up in these two cases:

1. One tacho pulse per engine cycle, meaning that the RPM is only calculated once per cycle. In this case the order tracking will compensate for changes in the engine RPM during the measurement, but not for changes within one cycle.
2. Several tacho pulses per revolution, meaning that the angular velocity is calculated for many angles during the engine cycle. In this

case order tracking will compensate for speed variations within one engine cycle. With this method those signals that are synchronous with the engine rotation angle are kept, the rest is averaged out.

The first of these methods is the easiest to use. It only requires one combined trigger and tacho source. The second requires independent trigger and tacho sources, since many tacho pulses are needed per revolution.

Just as for the trigger pulse, the tacho pulse used for tracking must be accurate and repeatable. An inaccurate tacho signal will ruin your tracking measurement.

Test Set-up and Instrumentation

To show the differences between the different methods, a test set-up consisting of an electric motor driving a small single cylinder, four-stroke engine was used (see Fig. 4).

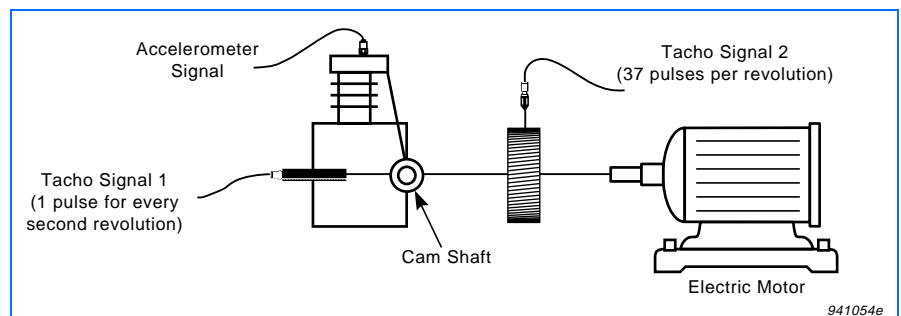

Fig.4 Test set-up. Tacho signal 1 used to trigger time records and for order tracking. Tacho signal 2 used for order tracking only

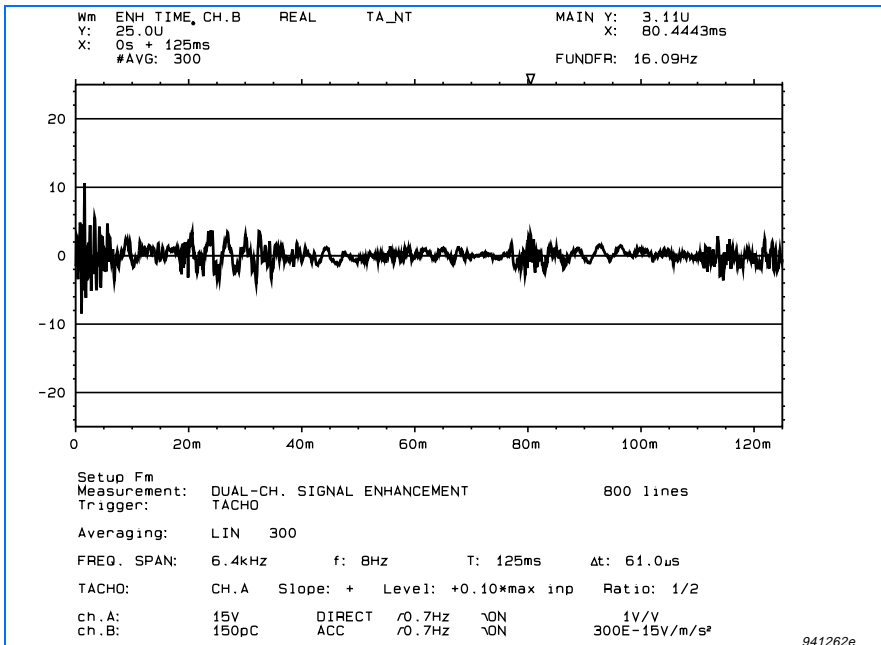

Fig 5 Signal enhancement, no order tracking

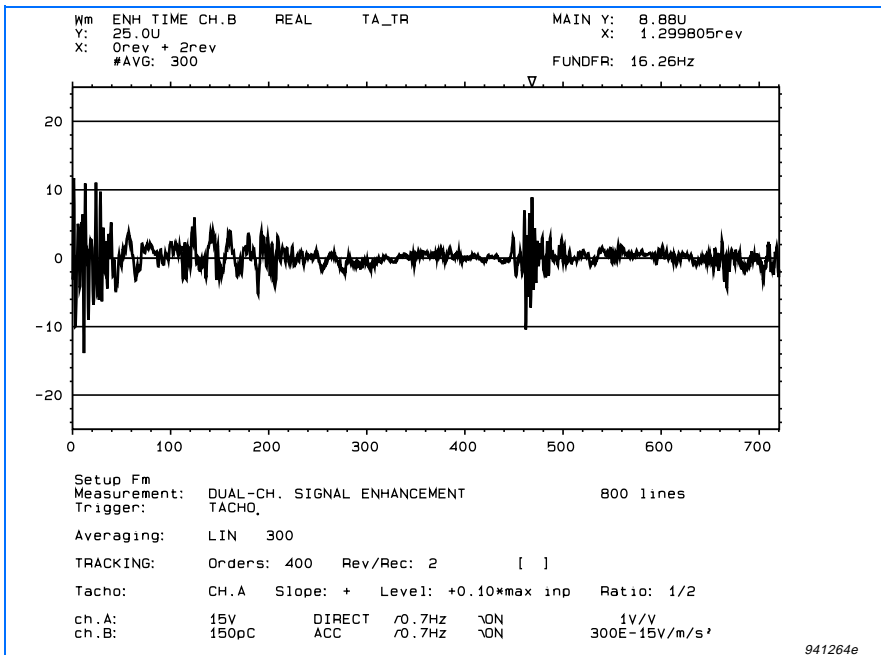

Fig 6 Signal enhancement, tracking using tacho 1 (one pulse per cam shaft revolution)

Three signals were measured:

1. Tacho signal 1 measured with a Photoelectric Probe MM0024. One pulse for every cam shaft revolution, i.e. once for every second engine revolution. This signal was used to trigger the time records, and also for tracking with one pulse per engine cycle.
2. Tacho signal 2 measured with a Photoelectric Probe MM0012. 37 pulses per engine revolution (crank shaft revolution). This signal was used for order tracking with many pulses per engine cycle.
3. Vibration signal measured with an Accelerometer Type 4393. The ac-

celerometer was close to the cylinder inlet and exhaust valves.

These signals were measured with a Type 3555 dual-channel analyzer, equipped with the Tracking Analysis Software Type 7670.

Three different measurements were performed:

1. Signal enhancement, no order tracking.
2. Signal enhancement, order tracking using tacho signal 1.
3. Signal enhancement, order tracking using tacho signal 2.

As can be seen in the cursor set-up (upper right corner of Fig. 5), the motor rotational speed was 16 revolu-

tions per seconds. One engine cycle takes two motor cycles, each engine cycle therefore takes 125ms. This is equal to the record time, which can be seen in the measurement set-up (below the graph).

In Fig. 5 you can see the time averaged accelerometer signal. There is a tendency that the signal level at the end of the record is lower than at the start of the record. This smearing of the time data is due to small changes in the RPM during measurement (300 averages).

The x-axis in Figs. 6 and 7 has been re-scaled from revolutions (0 to 2), to crank shaft angle (0° to 720°).

If you compare Fig. 6 with the non-tracking measurement in Fig. 5, you will notice that the magnitude of the signal is more stable in the record; it does not fall off at the end of the record. This is due to the fact that order tracking compensates for RPM changes during the measurement.

Still, this measurement does not take into account changes in angular velocity within one engine cycle which are significant in this case.

The measurement shown in Fig. 7, which used order tracking with many pulses per engine revolution, gives the clearest picture of what is happening. If you compare this measurement (Fig. 7), with those in Figs. 5 and 6, you will see that more features are visible in the enhanced time signal, but more important the re-scaled x-axis (in degrees) was only approximate in Fig. 6, but is much more accurate in Fig. 7.

This is because in the case shown in Fig. 6, with one tacho pulse per engine cycle, the crank angle rotation was assumed to be uniform during the engine cycle. Whereas it is measured and corrected 74 times per engine cycle in this case shown in Fig. 7. This means that certain portions of the graph shown in Fig. 6 have been compressed in the x-direction, other portions have been stretched. For example, you can see the exhaust valve opening at around 430° in Fig. 7. In Fig. 6 the same event seems to have taken place at about 460°.

Using the post-processing features of the Type 3555 analyzer, we can also examine portions of the enhanced time signal as shown in Fig. 8.

The x-axis of the upper graph has been re-scaled from revolutions (0 to 2), to crank shaft angle (0° to 720°). The x-axis of the lower graph has been re-scaled from orders (0 to 400), to frequency (0 to 6484 Hz).

It can be seen that the resonance caused by the clicking of the valve at 430° of shaft rotation, has a predominant frequency of about 2300 Hz.

What is the maximum RPM that can be measured?

Using a basic 3555, the max. RPM that allows one full engine cycle to be measured in real-time can be found as in the following example:

We want to measure on a 4-stroke engine and we want to average records of 2048 samples (800 spectral lines). What is the max. RPM?

- A 4-stroke engine has 2 engine revolutions per engine cycle.
- 800 lines for 2 revolutions means that the order span will be 400.
- The max. engine speed is equal to the max. frequency span, 12.8 kHz, divided by 400, i.e. 32.
- RPM is equal to rotations per second (32) times 60, i.e. 1920.

In Table 1 the max. RPM has been calculated for a number of different combinations of record sizes and motor types.

Using the analyzer's Time History feature, these RPM values can all be doubled. Using this feature means that the measurement will not be performed in real-time.

Using 100 kHz Input Modules Type 3020 will, of course, also improve the performance.

Conclusion

As we have seen, the method of signal enhancement combined with order tracking, is very well suited to analyse the dynamics of a reciprocating engine. The use of signal enhancement will average out all components not correlated with the engine rotation. With the enhanced time signal, we can see what happens at different rotations of the crank shaft. As we have seen, it is also possible to measure the frequency content of the vibrations occurring at different crank shaft angle rotations.

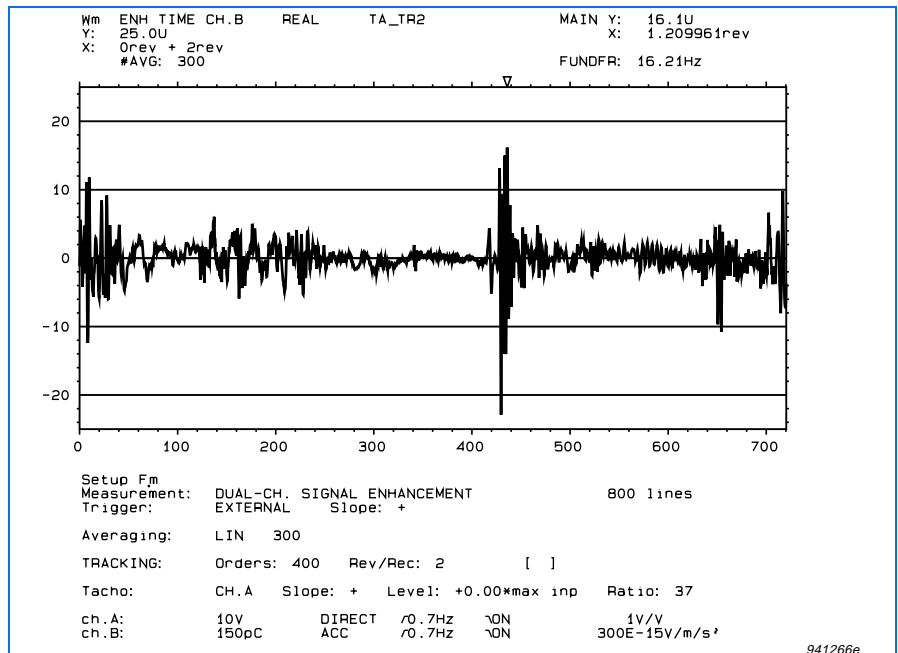

Fig.7 Signal enhancement, tracking using tacho 2 (37 pulses per engine revolution)

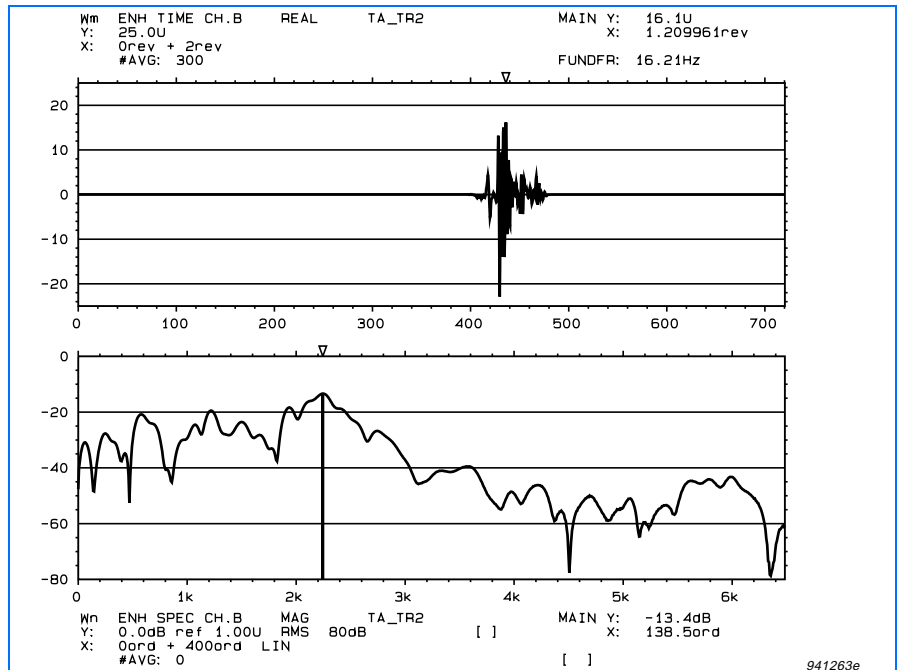

Fig.8 Windowed portion of enhanced time signal (top graph), and the frequency spectrum of that same portion (bottom graph)

Record size / Spectral lines	4-stroke engine (720° crank shaft rotation)	2-stroke engine, or pump (360° crank shaft rotation)
2048 / 800	1920 RPM	960 RPM
1024 / 400	3840 RPM	1920 RPM
512 / 200	7680 RPM	3840 RPM

Table1 Maximum RPM for different combinations of record size and motor type

Brüel & Kjær

WORLD HEADQUARTERS:

DK-2850 Naerum · Denmark · Telephone: +45 45 80 05 00 · Fax: +45 45 80 14 05 · Internet: <http://www.bk.dk> · e-mail: info@bk.dk
 Australia (02) 9450-2066 · Austria 00 43-1-865 74 00 · Belgium 016/44 92 25 · Brazil (011) 246-8166 · Canada: (514) 695-8225 · China 10 6841 9625 / 10 6843 7426
 Czech Republic 02-67 021100 · Finland 90-229 3021 · France (01) 69 90 69 00 · Germany 0610 3/908-5 · Holland (0)30 6039994 · Hong Kong 254 8 7486
 Hungary (1) 215 83 05 · Italy (02) 57 60 4141 · Japan 03-3779-8671 · Republic of Korea (02) 3473-0605 · Norway 66 90 4410 · Poland (0-22) 40 93 92 · Portugal (1) 47114 53
 Singapore (65) 275-8816 · Slovak Republic 07-37 6181 · Spain (91) 36810 00 · Sweden (08) 71127 30 · Switzerland 01/94 0 09 09 · Taiwan (02) 713 9303
 United Kingdom and Ireland (0181) 954-236 6 · USA 1 - 800 - 332 - 2040

Local representatives and service organisations worldwide

BO 0420-11