

Application Note

Improved Method for Complex Modulus Estimation

by Lauge Fulgsang Nielsen, Building Materials Laboratory, The Technical University of Denmark & N. Johan Wismer, S. Gade, Brüel & Kjær, Denmark

In industrial products, vibration and the noise it creates is often a major parameter to be taken into account. It is therefore usually very important to measure the material properties i.e. stiffness and damping, that determine how vibrations are generated, transmitted and damped. This application note describes a method developed by Mr. Fulgsang Nielsen which will allow the standard non-resonant method for the determination of complex modulus to be used at higher frequencies than otherwise possible. It is also shown how this method can be implemented using the Multichannel Analysis System Type 3550.



942099e

Introduction

One of the most fundamental relations governing the dynamic properties of materials is Hooke's law of elasticity.

Hooke's law (see Fig. 1) states that there is a *linear relationship between stress (σ) and strain (ϵ)*. Stress is force per unit area, i.e. pressure, and it is measured in Newtons per square meter (N/m^2) also called Pascal (Pa). Strain is relative deformation, i.e. deformation divided by the original dimensions, and is therefore dimensionless.

The ratio between stress and strain, E is called the modulus of elasticity or Young's modulus, and as for stress, it is measured in Pascal. Like mass density, the modulus of elasticity is a material constant. For steel it is approximately 200 GPa (200×10^9 Pa), and for aluminium it is approximately 70 GPa.

Hooke's law describes many materials very accurately, especially metals which have relatively low damping coefficients.

For many other materials, such as polymers and wood, the damping is so large that it cannot be ignored.

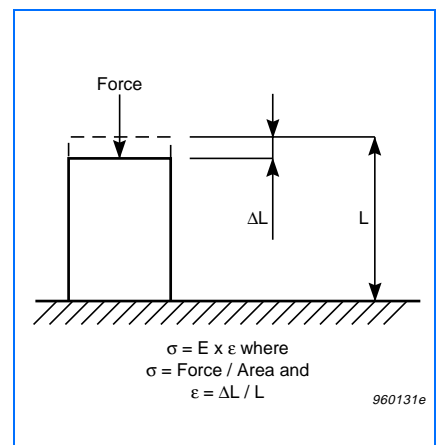

960131e

Fig.1 Hooke's law

Viscoelastic Materials

Viscoelastic models are often introduced when Hooke's law is deemed inaccurate. A few basic models are shown in the following:

Hooke: $\sigma = E\varepsilon$

Newton: $\sigma = \eta\dot{\varepsilon}$

Maxwell: $\dot{\sigma}/E + \sigma/\eta = \dot{\varepsilon}$

Kelvin: $\sigma = \eta\dot{\varepsilon} + E\varepsilon$

A dot above a symbol indicates time derivative. Hooke's law describes purely elastic materials, and Newton's law describes purely viscous materials.

To make these equations more intuitively understandable, "spring and dashpot" models can be drawn (see Fig. 2).

Many more viscoelastic models can be constructed by adding more springs and/or dashpots, in series or in parallel, to the models above.

The viscoelastic models introduce a time, and therefore also a frequency, dependency between stress and strain. If we look at the frequency domain representation of the relations, we get the following equations:

Hooke: $\sigma(j\omega) = E \times \varepsilon(j\omega)$

Newton: $\sigma(j\omega) = j\omega\eta \times \varepsilon(j\omega)$

Maxwell: $\sigma(j\omega) = \frac{j\omega\eta E}{j\omega\eta + E} \times \varepsilon(j\omega)$

Kelvin: $\sigma(j\omega) = (j\omega\eta + E) \times \varepsilon(j\omega)$

Where j is the imaginary number, and ω is the frequency in rad/s. The presence of j indicates that stress and strain are not usually in phase for viscoelastic materials.

The advantage of the frequency domain representation is that we can return to the simple linear relationship used for Hooke's law. We just have to introduce the *complex modulus of elasticity*, E_c , which is a complex function of frequency.

$$E_c = E_c(\omega) = \frac{\sigma(j\omega)}{\varepsilon(j\omega)} \quad (1)$$

where E_c is defined as follows:

Hooke: $E_c = E$

Newton: $E_c = j\omega\eta$

Maxwell: $E_c = \frac{j\omega\eta E}{j\omega\eta + E}$

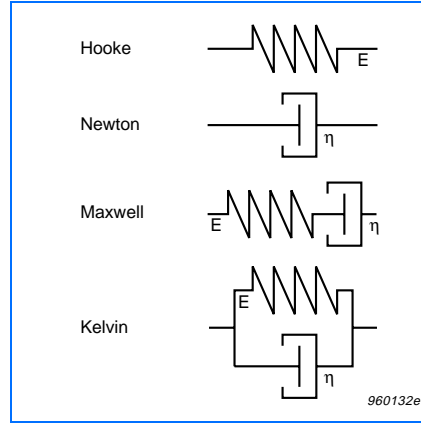

Fig.2 Spring and dashpot models of various viscoelastic materials

Kelvin: $E_c = j\omega\eta + E$

Note that for all viscoelastic models, the magnitude of E_c , i.e. the absolute Young's modulus, $|E_c|$, will either be constant or increase as a function of frequency.

The imaginary part, $\text{Im}(E_c)$ of E_c divided by the real part, $\text{Re}(E_c)$ of E_c is referred to as the *Loss Factor* and is an indicator of the damping of the material. A number of other damping descriptors are described in Ref. [2].

After this short introduction to viscoelastic models, the question that remains is how to measure the complex modulus of elasticity?

Material Properties contra System Properties

When we want to measure the modulus of elasticity, the first method that comes to mind is a simple displacement versus force measurement (i.e. "mobility", compliance, receptance, flexibility or admittance measurement) on a block of the material of interest.

Knowing the dimensions of the test specimen, the complex modulus can be calculated based on a simple frequency response function (FRF) measurement of compliance:

$$E_c = L/A \times 1 / FRF(\omega) \quad (2)$$

where

$$FRF(\omega) = \Delta L(\omega) / Force(\omega) \quad (3)$$

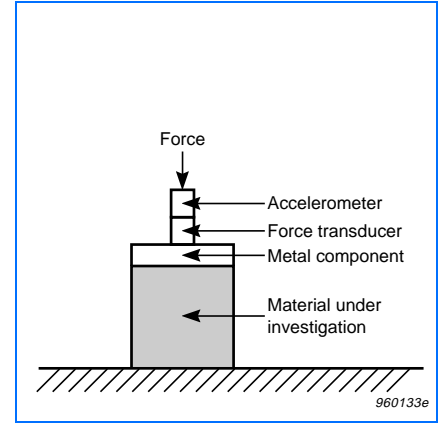

Fig.3 Simple set-up for measurement of complex modulus

L is once again the length, and A is the cross-sectional area of the test specimen.

This is the so-called non-resonant method for the estimation of complex modulus (see Ref.[3]). See Ref.[1] for an introduction to frequency response measurements on simple SDOF systems.

At low frequencies the method works really well, but at higher frequencies the mass of the test specimen and of the other components will begin to affect the measurement. Put in another way, at higher frequencies, the inertial forces cannot be ignored anymore. So as we get close to the first resonance frequency, the FRF is no longer only an expression of the material properties, but also of the system properties of the complete test specimen and test setup.

Here is where Mr.Fuglsang Nielsen's method comes in, see Ref. [5]. Since we know the geometry of the specimen, it is possible to find an analytic solution of how this simple system vibrates. If we assume that the metal components on top of the test specimen can be described as a lumped mass, the theoretical compliance of this simple system can be shown to be:

$$Compliance(\omega) = \frac{\Delta L(\omega)}{Force(\omega)} =$$

$$\frac{\sin(\beta)}{\omega^2 (M_s/\beta \times \cos(\beta) - M \times \sin(\beta))} \quad (4)$$

where

$$\beta = \sqrt{\omega^2 L^2 \rho / E_c} \quad (5)$$

ρ is the mass density of the test material (kg/m^3), M_s is the mass of the test specimen ($A \times L \times \rho$), M is the lumped mass of the metal components on top of the specimen, and E_c is the complex modulus of elasticity of the specimen material.

Equation (4) will not be derived here, but it involves solving a partial differential equation of the type:

$$EA \frac{\partial^2 u}{\partial x^2} - \rho A \frac{\partial^2 u}{\partial t^2} = 0$$

subject to the constraints:

$$u = 0 \quad \text{for } x = 0$$

$$EA \frac{\partial u}{\partial x} = F - M \frac{\partial^2 u}{\partial t^2} \quad \text{for } x = L$$

u is the displacement, which is a function of both position, x , and time t .

The compliance ($\Delta L / \text{Force}$) is found from the frequency response measurement, and A , L , ρ , and M can be measured with great accuracy. This leaves only one unknown in equations (4) and (5), namely E_c which can be found by a simple iterative process.

The modified non-resonant method can be said to peel the system characteristics from the measurement data, leaving only the material properties.

Practical Measurement

To perform the measurement, the test set-up shown in Fig. 4 was used.

The test specimen was made of rubber, it was cylindrical, with a diameter of 20 mm and a height of 60 mm. The following parameters were either measured or calculated.

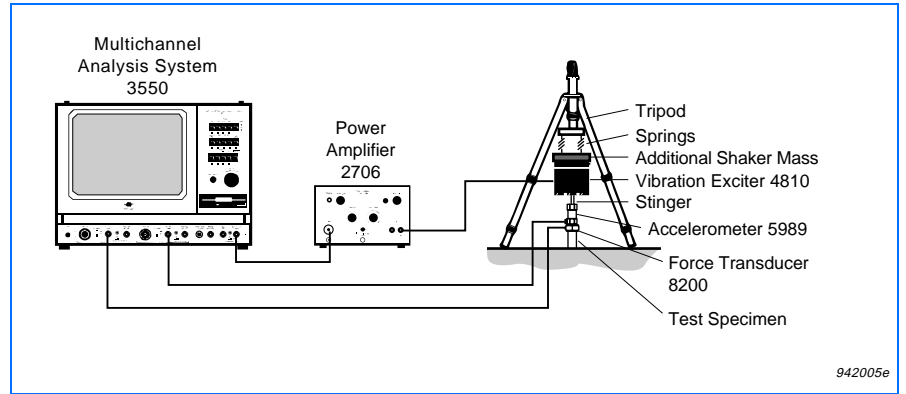

Fig. 4 Test setup for the measurement of complex modulus

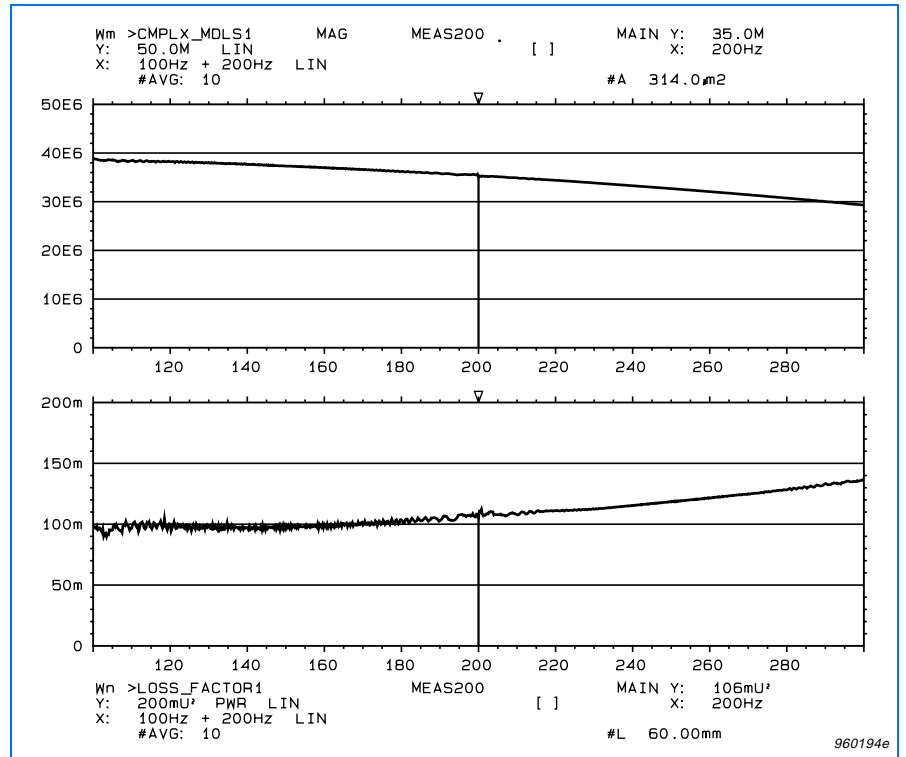

Fig. 5 Magnitude of complex modulus and loss factor found using equation (2)

- $A = 314 \text{ mm}^2$
- $L = 60 \text{ mm}$
- $\rho = 1058 \text{ kg/m}^3$
- $M_s = 19.9 \text{ g}$
- $M = 11 \text{ g}$

The first measurement (Fig. 5) was at low frequencies (100 to 300 Hz). The upper graph shows the User-Definable Display Function (UDDF) CMLPX_MDLS1 (definition in Fig. 6) which is an inverted H1 frequency

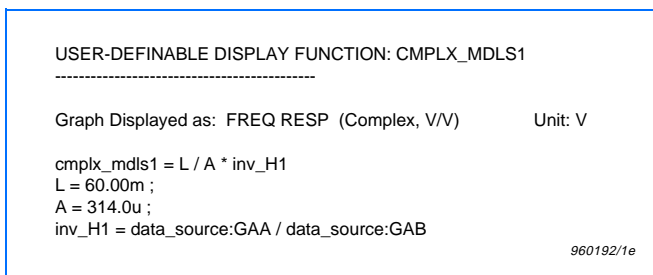

Fig. 6 Definition of the UDDF CMLPX_MDLS1

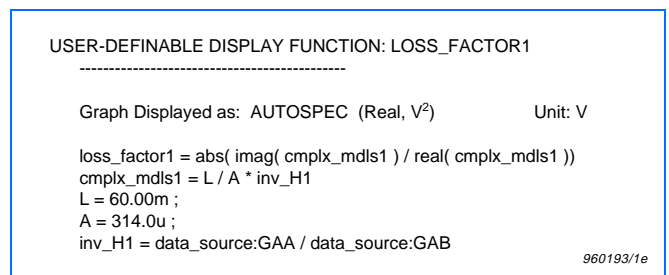

Fig. 7 Definition of the UDDF LOSS_FACTOR1

response function that has been scaled by the factor L/A , i.e. using equation (2). The lower graph shows the LOSS_FACTOR1 (definition in Fig. 7).

Both curves look trustworthy, but as stated earlier, no viscoelastic model will allow for a decrease of the magnitude of the complex modulus of elasticity as a function of frequency. So something is obviously wrong here.

If we look at Fig. 8, which shows a measurement at higher frequencies (100 to 900 Hz), the frequency response function clearly indicates that there is a resonance at 552 Hz. So we can see that the shapes of CMPLX_MDLS1 and LOSSFACTOR1 are, at least, partly due to the fact that we are getting close to the first resonance frequency.

Fig. 9 shows the two UDDFs CMPLX_MDLS1 and LOSS_FACTOR1, and at this higher frequency range, it can clearly be seen that both are strongly affected by the resonance. The inertial forces disturb the measurement even at much lower frequencies than the resonance frequency, and the question is whether the displayed values can be trusted even at 100 Hz.

What is needed is a method to remove the effect of the inertial forces, and this is precisely what the modified non-resonant method described earlier will do.

The Type 3550 can now perform the computations needed to compensate for the system characteristics of this simple system using equations (4) and (5).

The definition of the intermediate User-Definable Auxiliary Information (UDAI) BETA_OK is shown in Fig. 10. When BETA_OK is activated in the cursor set-up, it performs a Newton iteration to find the β of equation (5). A detailed explanation of how this UDAI works is beyond the scope of this note (see Ref. [4]).

While the iteration process is in progress, BETA_OK will show "failed". After 10 iterations, which is much more than necessary, the value of BETA_OK will change to "passed".

The BETA_OK UDAI is then deactivated and the two UDDFs CMPLX_MDLS (definition in Fig.11) and LOSS_FACTOR (definition in Fig.12) can then be displayed.

These two UDDFs use the beta found by BETA_OK to calculate the complex modulus of elasticity and the loss factor, using equation (5).

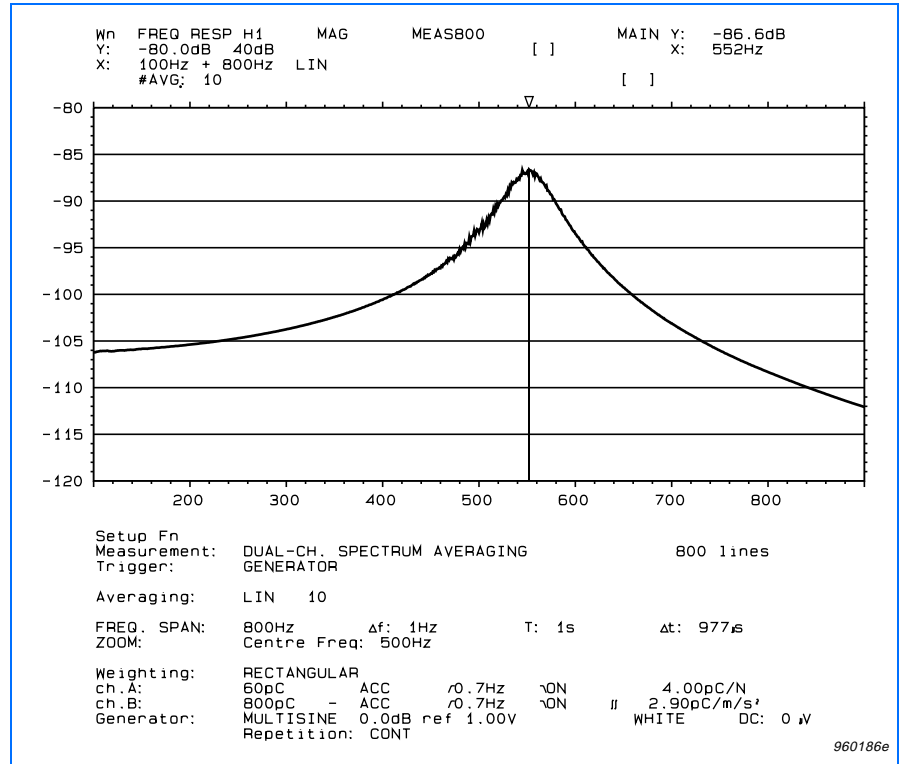

Fig. 8 Frequency response function of compliance (100 to 900 Hz)

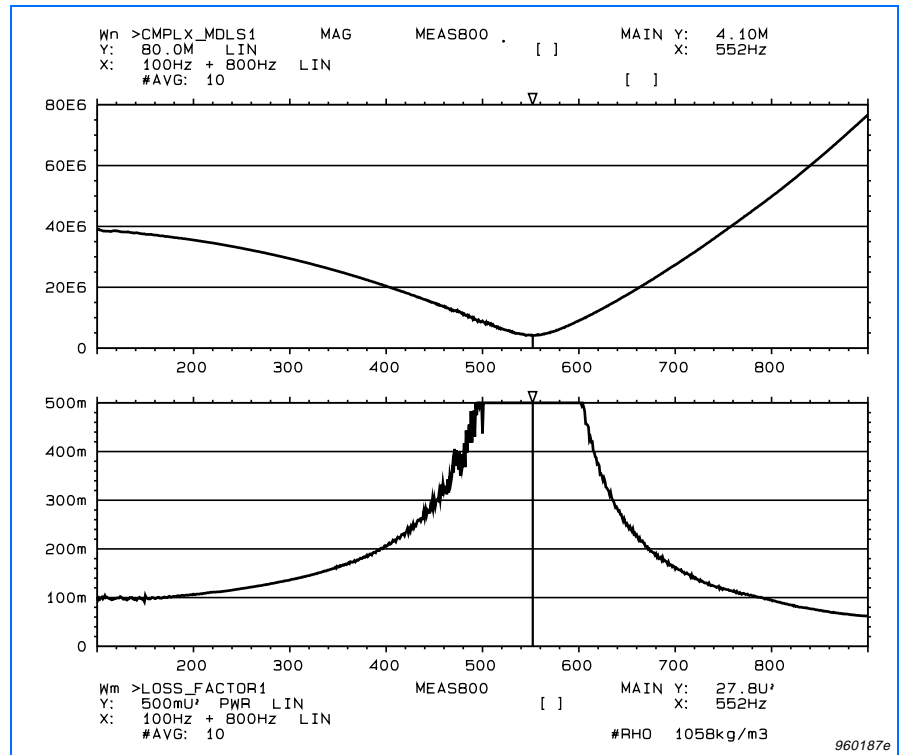

Fig. 9 Both complex modulus and loss factor are erroneous close to the resonance frequency

The result of CMPLX_MDLS and LOSS_FACTOR are shown in Fig. 13. The two curves look very different from the curves in Fig.9. *The effect of the resonance cannot be seen anymore!*

The magnitude of the complex modulus of elasticity can be seen to be slightly increasing, and is about 40 MPa. The loss factor is very close to 0.1 in the frequency range from 100 to 900Hz. In the 100 to 900 Hz frequency range the complex modulus of elasticity can be said to be approximately:

$$E_c = 40 \text{ MPa} + 4 \text{ MPa} \times j$$

To see how the modified non-resonant method behaves at higher frequencies, a high frequency measurement was performed. The upper graph in Fig.14 shows the frequency response from 100 to 3300 Hz, the second resonance can be seen at 2048 Hz. Note that there is a difference of more than 40 dB between the highest and the lowest FRF level.

The magnitude of the complex modulus was relatively stable at about 40 to 50 MPa in the full frequency range up to 3200 Hz, and is therefore not shown.

The loss factor is shown in the lower graph, and can be seen to become very noisy at higher frequencies. The reason for this is that the inertial forces dominate at higher frequencies, i.e. stiffness and damping have very little effect on the FRF on which the calculations are based.

At higher frequencies, this method is also very sensitive to errors in the analytical model; if the real system deviates too much from the model, then errors will be introduced. All system parameters (A , L , ρ , M_s , M) must be measured with high accuracy.

Finally, we can check whether the loss factor is consistent with the loss factor found by the resonance bandwidth method.

USER-DEFINABLE AUXILIARY INFORMATION: BETA_OK

dB reference: 1.00V
Reading: PASSED / FAILED

```
beta_ok = re_execute_UDF_if( count < 9.5 ) & beta
beta = save( new_estimate( beta2( beta ) ) )
new_estimate(beta) = beta - delta_beta( beta, c_sin(beta), c_cos(beta) )
beta2(beta) = select( count < 1.5, beta_guess, beta )
count = count + 1
delta_beta(b,sb,cb) = y(b,sb,cb) / dy(b,sb,cb)
c_sin(b) = -0.5*j * (exp(j*b) - exp(-j*b))
c_cos(b) = 0.5 * (exp(j*b) + exp(-j*b))
beta_guess = sqrt( omega_sq * L_sq * rho / E_guess )
y(b,sb,cb) = (inv_H1 + M_omega_sq) * sb - Mr_omega_sq / b * cb
dy(b,sb,cb) = Mr_omega_sq/b*sb+(inv_H1+M_omega_sq+Mr_omega_sq/sb(b))*cb
L_sq = sq( L )
E_GUESS = 50.00M ;
inv_H1 = data_source:GAA / data_source:GAB
M_omega_sq = M * omega_sq
Mr_omega_sq = Mr * omega_sq
omega_sq = sq( omega )
sq(x) = x * x
M = 11.00m ;
Mr = A * L * rho ; kg
RHO = 1058 ;
L = 60.00m ;
A = 314.0u ;
```

960188e

Fig.10 The definition of the UDAI BETA_OK

This method states that the loss factor at a resonance is approximately equal to the half-power bandwidth divided by the resonance frequency.

The UDAI LF_AT_RESON (definition is shown in Fig. 15) will perform this calculation at the resonance which is selected by the main cursor.

Fig.16 shows the frequency response function in the upper graph, and the loss factor found by the modified non-resonant method in the lower graph.

In the upper cursor setup, the UDAI LF_AT_RESON has been activated and is reading out 0.089, and at the same frequency the main cursor is reading out 0.095 in the lower graph.

Caveats

Two points requiring special attention will be mentioned at this final stage.

The first deals with the numerical method used to find the solution to equations (5). The problem here is that there are several numerical solutions, but it is only the first of these solutions that yield the correct β , which is in turn used to calculate the complex modulus of elasticity by use of equation (4). In this application note, the method used to find the solution to the numerical problem is the well known Newton-Raphson method. This method requires an initial guess. Our initial guess is that the modulus of elasticity is real (i.e.

USER-DEFINABLE DISPLAY FUNCTION: CMPLX_MDLS

Graph Displayed as: FREQ RESP (Complex, V/V) Unit: V

```
CMPLX_MDLS = save( omega_sq * L_sq * rho / beta_sq )
omega_sq = sq( omega )
L_sq = sq( L )
RHO = 1058 ;
beta_sq = sq( get:beta )
sq(x) = x * x
L = 60.00m ;
```

960189/1e

Fig.11 The definition of the UDDF CMPLX_MDLS

USER-DEFINABLE DISPLAY FUNCTION: LOSS_FACTOR

Graph Displayed as: AUTOSPEC (Real, V2) Unit: V

```
loss_factor = abs( imag( cmplx_mdls ) / real( cmplx_mdls ) )
CMPLX_MDLS = save( omega_sq * L_sq * rho / beta_sq )
omega_sq = sq( omega )
L_sq = sq( L )
RHO = 1058 ;
beta_sq = sq( get:beta )
sq(x) = x * x
L = 60.00m ;
```

960190/1e

Fig.12 The definition of the UDDF LOSS_FACTOR

purely elastic) and constant over all frequencies. Looking at Fig.10, you will see that there is an equation called E_GUESS = 50 MPa which defines the initial guess. Had we started with a much higher value of E, we might have found a completely different (and wrong) result. Care should therefore be taken when setting this value. A good initial guess will usually be the static modulus of elasticity, i.e. the modulus of elasticity at very low frequencies.

The second point deals with the required accuracy of measurements. As it was stated earlier, the method described in this application note requires that measurements of all the involved parameters must be made with great care. The phase of the measured frequency response function in particular, becomes particularly critical when one is trying to measure the loss factor of materials with little damping. If the material under test has a loss factor of, let us say 0.01 and if the uncertainty in the estimation of the phase is in the order of 1° (≈ 0.017 radians), then the measurement becomes almost meaningless as the uncertainty is almost twice as large as the value we are trying to estimate. The rubber material we tested was not too critical, it had a relatively large loss factor, but it is strongly recommended to make a reference measurement between acceleration and force on a vibrating stiff mass in the frequency range of interest. Then use this measurement to equalize the frequency response function, if the material being investigated is known to have small damping.

Conclusion

The purpose of this application note has been to show that a better estimate of the complex modulus of elasticity can be calculated based on a simple non-resonant measurement. The advantages of this modified non-resonant method as opposed to the widely used resonant method, are twofold. First, it delivers not only damping, but also stiffness, and second, the information is available at all frequencies, and not only at the resonant frequencies.

It can be seen that the modified non-resonant method has some problems at higher frequencies. One rea-

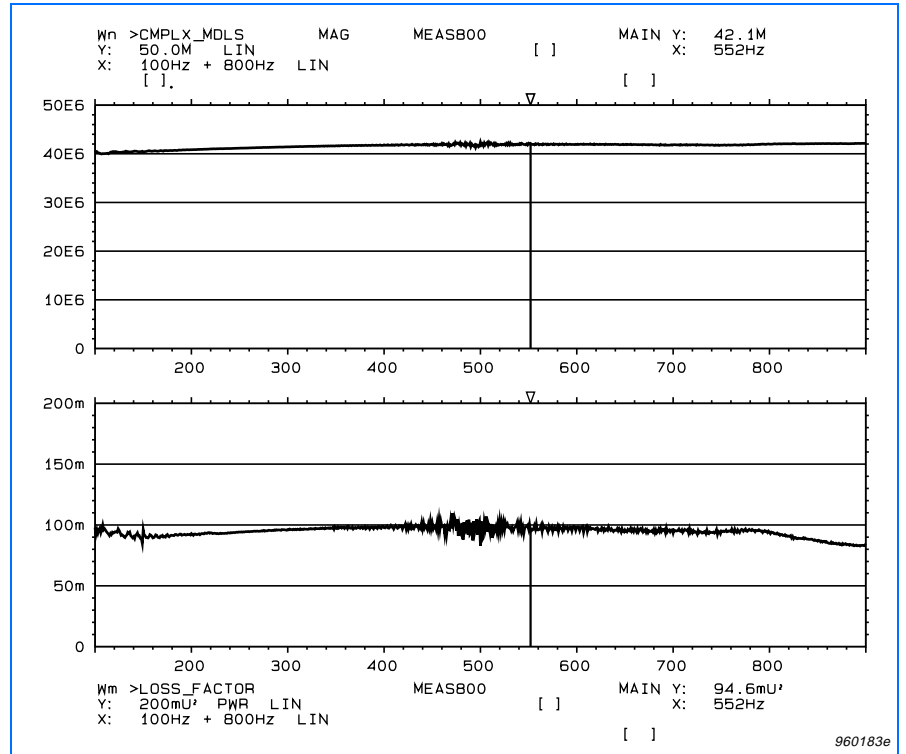

Fig.13 Magnitude of complex modulus and loss factor found using equation (4) and (5)

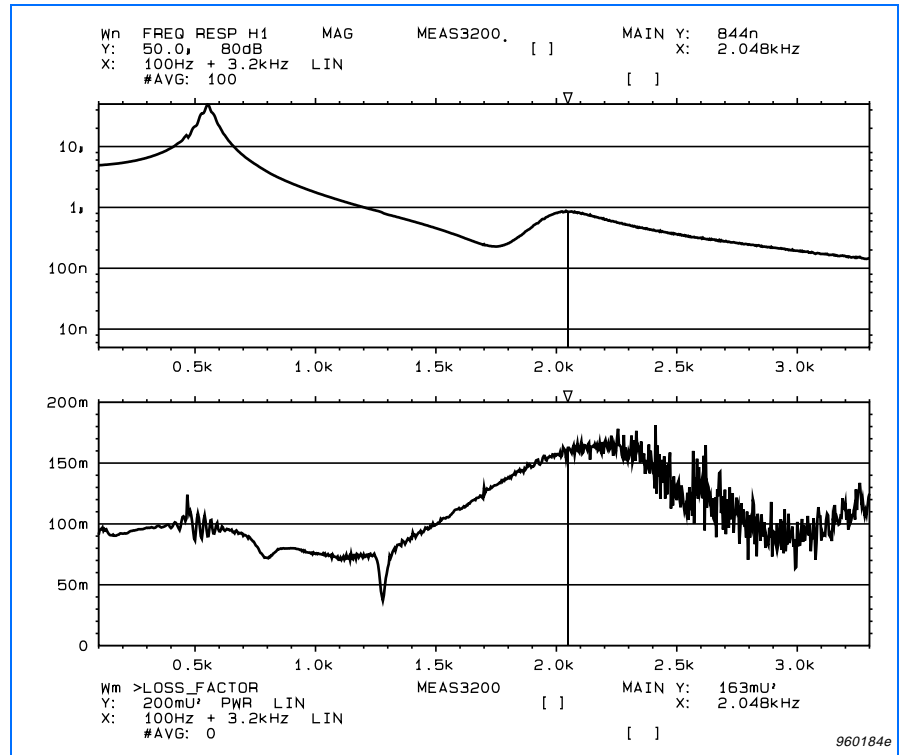

Fig.14 FRP and loss factor, 100 to 3300 Hz

son for this is due to the fact that the model used is not 100% exact. Any small misalignment between the higher resonance frequencies in the model and the real ones will influence the estimated complex modulus. It was also seen that that the loss factor estimate got more and more noisy at higher frequencies. This is again understandable if we remember that the inertial forces dominate at higher frequencies, i.e. stiffness and damping have very little effect on the FRF. But all in all, the modified non-resonant method is a clear improvement over other methods.

References

- [1] HERLUFSEN, H.: "Dual channel FFT analysis (Part 1 & 2)" Brüel & Kjær Technical Review, No.1 & 2, 1984
- [2] GADE, S. & HERLUFSEN, H.: "Digital Filter Techniques vs. FFT Techniques for Damping Measurements", Brüel & Kjær Technical Review, No.1, 1994
- [3] GADE, ZAVERI, KONSTANTIN-HANSEN, HERLUFSEN: "Complex Modulus and Damping Measurements using Resonant and Non-Resonant Methods", Brüel & Kjær Technical Review, No.2, 1994
- [4] Multichannel Analysis System Type 3550, Manual Vol.3, User-definable Functions, BE 1081, Brüel & Kjær, 1991
- [5] NIELSEN, L. FUGLSANG: "Material properties determined by vibration analysis", Danish Society for Materials Testing and Research, Denmark, Materialenyt 1, 1995

```

USER-DEFINABLE AUXILIARY INFORMATION: LF_AT_RES
-----

Reading: ABSOLUTE                               Reading Unit:

LF_at_res = Bandwidth_3dB / Res_freq
Bandwidth_3dB = Right_3dB - Left_3dB
Res_freq = Freq_span_start + delta_f * Res_index
Right_3dB = delta_f * right_index
Left_3dB = delta_f * left_index
right_index = right_index_1 + right_ratio
left_index = left_index_1 - left_ratio
right_ratio = mag_right_1 / ( mag_right_1 - mag_right_2 )
left_ratio = mag_left_1 / ( mag_left_1 - mag_left_2 )
mag_right_1 = extract_element( shifted_FRF, right_index_1 )
mag_right_2 = extract_element( shifted_FRF, right_index_2 )
mag_left_1 = extract_element( shifted_FRF, left_index_1 )
mag_left_2 = extract_element( shifted_FRF, left_index_2 )
right_index_2 = right_index_1 + 1
right_index_1 = crossover_right( shifted_FRF, Res_index )
left_index_2 = left_index_1 - 1
left_index_1 = crossover_left( shifted_FRF, Res_index )
Shifted_FRF = mag_of_FRF - sqrt(0.5) * resonance_amp
Resonance_amp = extract_element( mag_of_FRF, Res_index )
Res_index = index_of_max( close_to_peak )
Close_to_peak = window( mag_of_FRF, index_of_x - 3, 7 )
Mag_of_FRF = mag( data_source:func ) ; data_source must be an FRF.
960448e

```

Fig.15 The definition of the UDAI LF_AT_RESON (loss factor at resonance)

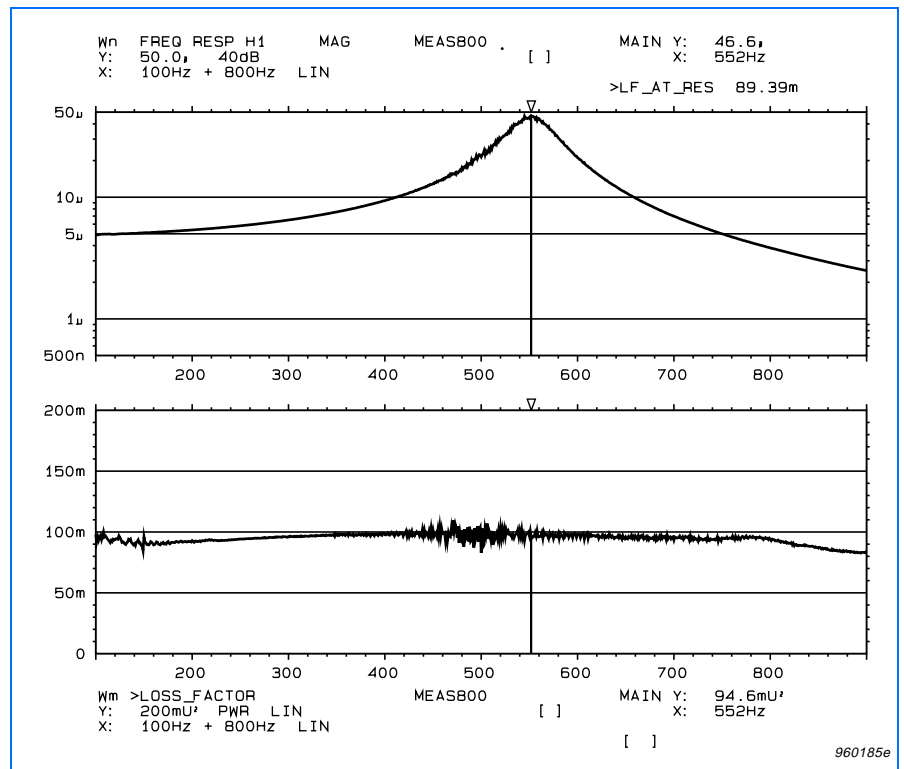

Fig.16 Loss factor calculated by resonance bandwidth method (upper cursor setup), and loss factor calculated by modified non-resonant method (lower graph)



WORLD HEADQUARTERS:

DK-2850 Naerum · Denmark · Telephone: +45 45 80 05 00 · Fax: +45 45 80 14 05 · Internet: <http://www.bk.dk> · e-mail: info@bk.dk
Australia (02) 9450-2066 · Austria 00 43-1-865 74 00 · Belgium 016/44 92 25 · Brazil (011) 246-8166 · Canada: (514) 695-8225 · China 10 6841 9625 / 10 6843 7426
Czech Republic 02-67 021100 · Finland 90-229 3021 · France (01) 69 90 69 00 · Germany 0610 3/908-5 · Holland (0)30 6039994 · Hong Kong 254 8 7486
Hungary (1) 215 83 05 · Italy (02) 57 60 4141 · Japan 03-3779-8671 · Republic of Korea (02) 3473-0605 · Norway 66 90 4410 · Poland (0-22) 40 93 92 · Portugal (1) 47114 53
Singapore (65) 275-8816 · Slovak Republic 07-37 6181 · Spain (91) 36810 00 · Sweden (08) 71127 30 · Switzerland 01/94 0 09 09 · Taiwan (02) 713 9303
United Kingdom and Ireland (0181) 954-236 6 · USA 1 - 800 - 332 - 2040
Local representatives and service organisations worldwide
BO 0427 – 11