

OPERATIONAL MODAL ANALYSIS ON WIND TURBINE BLADES

In the spiritual home of wind energy, Denmark, researchers try to understand how the forces of nature act on wind turbines. They find the structural resonances and understand how blades bend and twist in real, operational use – the modes. The real-world data feeds back into virtual design models, helping to improve them.



CHALLENGE

Improve the understanding of wind turbine dynamics, improve the structural characterization techniques and use real-world operational test results to update finite element (FE) models, while fulfilling IEC standards

SOLUTION

A complete toolset: transducers, distributed data acquisition hardware, a single software platform for operational modal analysis (OMA) and correlation of test results with FE results

RESULTS

- Deeper understanding of blade dynamics
- Faster, easier testing procedures
- Updated, more accurate FE models
- OMA knowledge applied to operational measurements, preparing for permanent structural monitoring



BACKGROUND

The blades on a modern wind turbine are high-technology products. They are the most expensive part of the wind turbine and their design is critical to achieve efficient, robust and reliable systems. These complex structures have complicated geometry and material configurations, and must endure demanding loads over long periods. The blades receive the full load of the wind over a typical lifetime of 20 years, making stiffness, buckling resistance, flexibility and extreme strength essential.

In a quickly developing industry, manufacturers are continually developing bigger wind turbines. The last decade saw a rapid growth of turbine size and proliferation of blades with optimized materials and design methods. The trend is towards extremely long and flexible blades on large, offshore wind turbines – such as the 86 metre-long blades made by SSP Technology.

Deeper knowledge needed

The understanding of blade structural performance is having to rapidly catch up – along with the measurement and analysis techniques and the equipment used. Manufacturers need to acquire a firm knowledge base with which to accelerate development of mature and durable products. New, advanced functions like blade pitch control challenge the structural performance of wind turbines, influencing designs and thus calling for a fuller understanding of their dynamic performance during operation.

Classical modal analysis vs operational modal analysis (OMA)

Classical modal analysis is based on excitation of the structure with a carefully measured amount of force, normally using an impact hammer or one or more modal exciters. The resulting vibration is measured and the relationship between the applied force and the resulting vibration gives the structures dynamic properties.

OMA differs as it does not need artificial force input. It uses natural, ambient forces such as wind, without having to measure them. OMA only measures the resulting vibration – making operational, in situ structural characterization possible, like on an operating turbine.

“THE IMPORTANCE OF HAVING A PICTURE OF A BLADE’S VIBRATION CHARACTERISTICS INCREASES WITH THE USE OF VERY LARGE BLADES FOR MULTI-MEGAWATT WIND TURBINES.”

Per Hørlyk Nielsen, Development Engineer at DTU Wind Energy



The design of a turbine’s speed controller is based on the whole turbine’s dynamic response. Like the blades, a controller’s design is based on numerical (computational) models of the wind turbine. However, the actual turbine’s dynamics always differ slightly from any model, causing its overall performance

to differ from what was predicted. What is needed is a means of improving the models with real-world test data.

Offshore challenges

Offshore turbines are proliferating intensely, and their components are exposed to demanding loads in highly aggressive environmental conditions. Offshore turbines are even more expensive to maintain and replace than their land-based counterparts, and their foundations are difficult to access. Consequently, structural health monitoring is a vital research area that holds the promise of helping operators to monitor turbines remotely using techniques like OMA to predict failures or maintenance requirements, detect damage, and improve the cost-effectiveness and efficiency of maintenance. The ultimate prize in this area is predictive structural health monitoring of the complete wind turbine.

An advantage of OMA measurements is that they can be done in situ and under actual operating and environmental conditions, providing more accurate test results. With better real-world structural testing, improved FE models can be developed by incorporating the measured actual dynamic structural properties.

CHALLENGE

DTU Wind Energy is a world-leading research department, and part of the Technical University of Denmark (DTU). Here, academics work on cutting-edge research alongside key industry partners. DTU Wind Energy has three wind turbine test sites in Denmark: A centre for large turbines at Høvsøre established in the 1990s, Østerild National Test Centre for Large Wind Turbines, and the Risø campus. Risø has long been associated with cutting-edge energy research, ever since the Nobel laureate Niels Bohr played a key role in its foundation – to promote the development of an innovative and sustainable society.

Knowing blade dynamics = understanding modes

Structures look solid but in fact they move all the time, deforming into different shapes as different forces act on them. To understand and visualize the complex ways in which a structure deforms – for example when and how they bend and when and how they twist – engineers decompose the shapes into unique modes of vibration, each describing a characteristic vibration pattern. Each mode has an associated natural frequency (the resonance frequency) and damping value. Together, the natural

frequency, the damping value and the mode shape are known as the modal parameters. At the resonances, the input forces are amplified, which can cause excessive vibration. However, the higher the damping value, the faster the response of a forced vibration will decay.

Avoiding excessive vibrations

Excessive vibrations can significantly reduce the lifetime of a structure and should generally be avoided. With blades that are heavily exposed to wind loads, it is essential to determine the frequencies at which they occur and understand the consequences. To do this, a detailed knowledge of the blade's modes that are excited during operation is required.

Low-frequency modes are of special interest to wind turbine researchers and manufacturers. The first natural resonance frequencies of long blades are extremely low (below 1Hz), so being able to effectively characterize them is vital – and very difficult with conventional analysis techniques.

As the blade cuts through the air, the air resistance excites the blade's 'twisting' (torsional) modes. With the current focus on blade pitch control, manufacturers need to understand the structure's response to this angle of attack. Knowledge of the lower torsional modes is particularly critical to designing a robust and safe pitch-altering mechanism.

Meeting international standards

The International Electrotechnical Committee (IEC) requires that blade designs are assisted by

Renewable energy in Denmark

From a high level of carbon dioxide per capita in the 1980s, Denmark has transformed its modern power industry, so that wind turbines accounted for 40% of the domestic electricity supply in 2014, and at certain times it reached 100%.

The Danish wind power industry is a world-leader, and home to turbine manufacturers Vestas and Siemens Wind Power, blade manufacturers LM Wind Power, SSP Technology, and a leading network of global suppliers. In addition to early subsidies in the wind industry and feed-in tariffs, a key reason for this success is the focus on building strong research environments with close ties to industry – the most famous of which is DTU and the Risø facility.

The government is aiming for 50% of energy production to be supplied by wind power by 2020, and for the country to be 100% free of fossil fuels by 2050.

Source: Ens.dk

blade manufacturing inspections and full-scale testing. As such, it is developing IEC standards for blade design and blade testing, where DNV (Nordic classification society) is a contributing member. DNV-DS-J102 addresses design, manufacturing and testing procedure requirements of onshore and offshore wind turbine blades.



“BRÜEL & KJÆR PROVIDED GOOD SUPPORT REGARDING POST-PROCESSING. IT'S ONE OF THE MOST IMPORTANT THINGS, AND PEOPLE ARE LOOKING FOR THAT IN ALL ASPECTS, ALSO IN NUMERICAL MODELLING. IF YOU CAN'T POST-PROCESS THE RESULTS OF NUMERICAL MODELLING, IT'S VERY HARD TO DEVELOP.”

Per Hørlyk Nielsen, Development Engineer at DTU Wind Energy

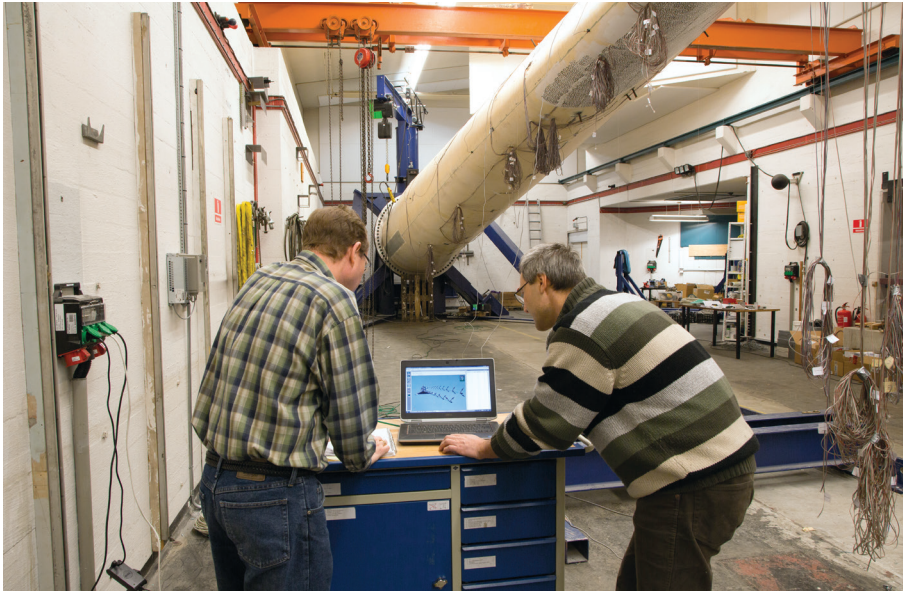

The unmeasured input for OMA must be broad-banded enough to excite all modes of interest. In addition, the spectral content should be fairly smooth and potential harmonic components should be removed. These conditions are easily satisfied using a cheap rubber mallet. Just two people exciting the blade randomly at different points was sufficient to measure the entire blade in a few minutes – although just one person could have easily performed the tests alone. Subsequent modal analysis and validation of the modal results took a few minutes

Although they have not been strictly followed throughout the industry, greater focus is being placed on adhering to standards by OEMs and operators alike – particularly those relating to noise and structural safety. This has led DTU Wind Energy to take a close interest in the area, and ensure all development research fulfills the requirements. Brüel & Kjær’s solutions perform measurement and analysis according to these standards.

SOLUTION

Structural characterization in the lab

A joint project between DTU Wind Energy and Brüel & Kjær’s experts sought to improve the accuracy of structural analysis results in the lab, while making the process faster and easier – and proving the concept for later operational measurements. Using operational modal analysis (OMA), Brüel & Kjær was able to transfer operational application knowledge to the wind industry that has been perfected in parallel industries such as aerospace, ship-

building and civil engineering – everywhere that large structures are loaded with natural ambient forces.

OMA vs classical modal analysis

In a lab there are no natural forces acting on the blade, so it is necessary to artificially excite the structure – done here with two large standard hammers – as there is no need to measure the input force. As OMA removes the conventional necessity of tapping at precise points, in precise directions, it is vastly simpler than conventional testing. As Dmitri Tcherniak, Research Engineer at Brüel & Kjær says: “When performing OMA, the results are very tolerant to the excitation. On this 34 metre-long blade, simple excitation with two standard hammers over different parts of the blade proved to be sufficient to get good results. In addition, OMA is better able than traditional hammer testing to capture low frequencies – which are critical to wind turbine blade design.”

The OMA test was performed in a single measurement to reduce test time and ensure the highest possible data consistency, by testing under the same conditions. As Per Hørlyk Nielsen says, “Compared with the traditional vibration measurements, which may obtain data from one or two accelerometers, this method gives important information about the modal properties of the blade. An example is mode shapes and damping values, which can be used to validate and update computational models for loads and structural strength predictions.”

Problems with conventional excitation methods in the lab

Roving hammer

A special impact hammer equipped with a force transducer (load cell) must precisely hit the structure multiple times in many pre-defined locations, in the correct directions. This presents huge practical constraints to accessing the structure – especially when it is large and suspended above the ground. The procedure is very time-consuming and potentially error-prone.

Fixed hammer

Using just a single hammer excitation point may result in insufficient energy distribution across the structure, giving inaccurate modal results.

Exciters

Low-frequency testing of large wind turbine blades requires that the extremities of the blade move large physical distances, which can be a challenge for many modal exciters due to the necessary stroke length. In addition, using modal exciters requires significantly more set-up time – especially when using more excitation points as required for sufficient energy distribution.

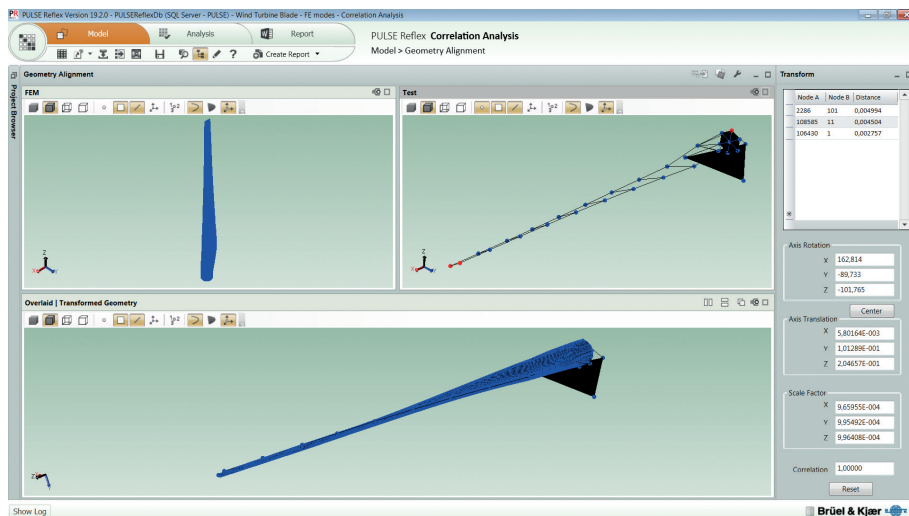

From thousands of nodes in the finite element model, (left) a test model is created that contains 20 nodes where accelerometers should be mounted for optimal results. In order to compare the test and FE results, the two geometry models must be aligned in space as regards orientation and scaling. This is easily done in PULSE Reflex Correlation Analysis by selecting three point pairs on the two models. The software automatically calculates the transformation matrix and the scaling factor and displays the models overlaid for easy visual comparison



Lightweight, triaxial Type 4524 accelerometers are securely mounted on swivel bases that allow the angle of each axis to be set according to pre-defined angles. With a very low noise floor, these accelerometers are accurate for low-frequency measurements and are automatically recognized by the LAN-XI data acquisition system using TEDS technology

Fast setup

Deciding where to mount accelerometers is simplified with dedicated PULSE Reflex™

Structural Dynamics software. This takes a finite element model of the blade and decimates the thousands of nodes (points) down

to 20, in order to make a simplified yet highly accurate test model. This test model contains the optimal measurement points at which to locate the accelerometers.

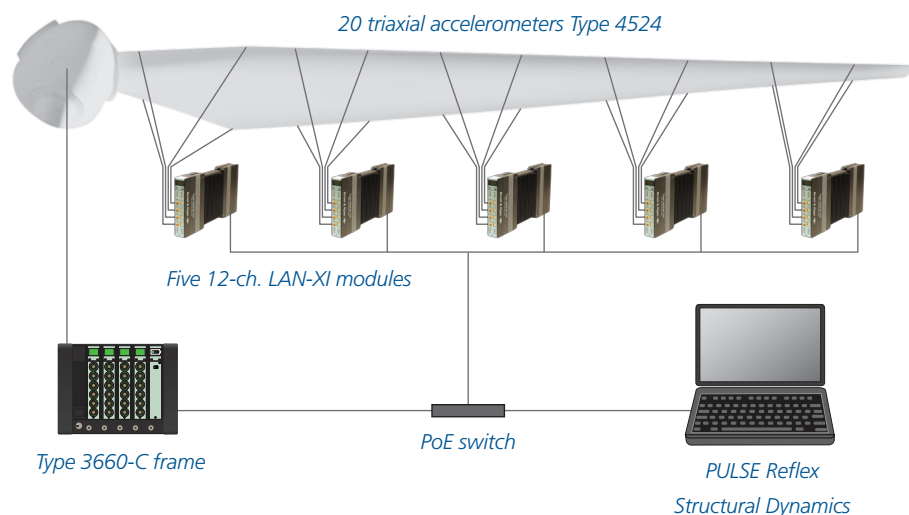

Five input modules were distributed over the blade close to the accelerometers. Each handled 12 channels – four triaxial accelerometers. For the support system, a LAN-XI Type 3660-C frame was used equipped with 2x 4/2-ch. input/output modules and 2x 6-ch. input modules

Distributed data acquisition

LAN-XI data acquisition modules were distributed over the length of the blade and connected to a network switch with a single LAN cable each. This supplies both power and assures perfectly sample-synchronized data acquisition. Each triaxial accelerometer requires three input channels, but all use a single connector for all three channels, to simplify set-up.

Distributing data acquisition modules close to the measurement points greatly reduced the cabling work typically required for multi-channel data acquisition. Minimizing the length of accelerometer cables also improves accuracy and reduces cost. And since OMA does not require measurable, controlled excitation, no cables were used for the hammers.

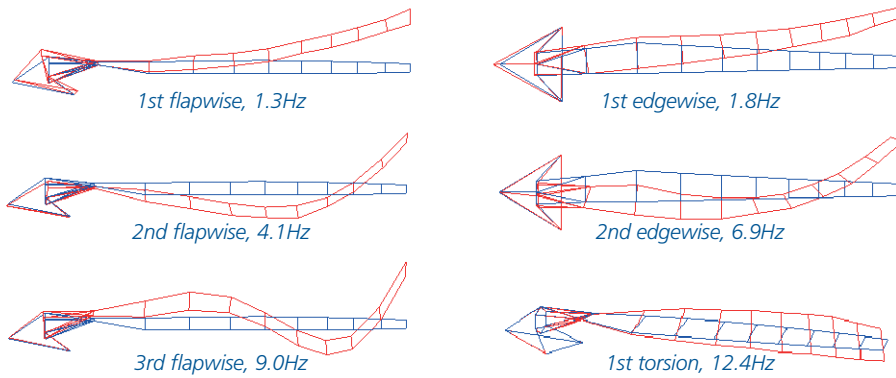

The first six elastic modes found using OMA

The blade was mounted in a heavy test rig. To check the rig's modes were well below the first elastic modes of the blade, six additional triaxial accelerometers were mounted on the rig.

OMA results

After the last cable was connected, the team could immediately start the measurement. "The equipment is easy to install and requires no preparation," says Per Hørlyk Nielsen, Development Engineer at DTU Wind Energy.

The test time was reduced vastly using OMA. The measurement on a 34 metre-long wind turbine blade required a measurement time of seven minutes to acquire simultaneous response measurements in 60 different degrees of freedom (DOFs). "Including the installation time, we can now perform a full modal test of a blade in just two days. It's amazing," says Dmitri Tcherniak, Research Engineer at Brüel & Kjær. "OMA is a very quick technique to get good results."

"The OMA software has powerful, unbiased time-domain SSI algorithms that greatly simplifies and automates the analysis. In just a few clicks it is possible to get the results," concludes Dmitri.

Structural characterization in the field

After proving the OMA technique in the lab, the joint project went a stage further with an extended monitoring test, using the same LAN-XI system on an entire wind turbine. For six months, accelerometers sent data from the turbine's rotating blades via a wireless link to a PC in the turbine's tower. The operators could remotely observe the structural behaviour of the turbine via the Internet in real-time, at will.

It made it possible to characterize the dynamic behaviour of the whole structure, with all three blades and the tower working dynamically together.



The data acquisition hardware was mounted in a single rack and secured in a waterproof box in the rotor housing. A slip ring was used for power transmission. Data was transmitted wirelessly to the PC in the tower, and synchronized using an IrigB time code



An OMA test using a rubber mallet was performed to check the system and the accelerometer mounting before the blade is reinstalled for a six-month test

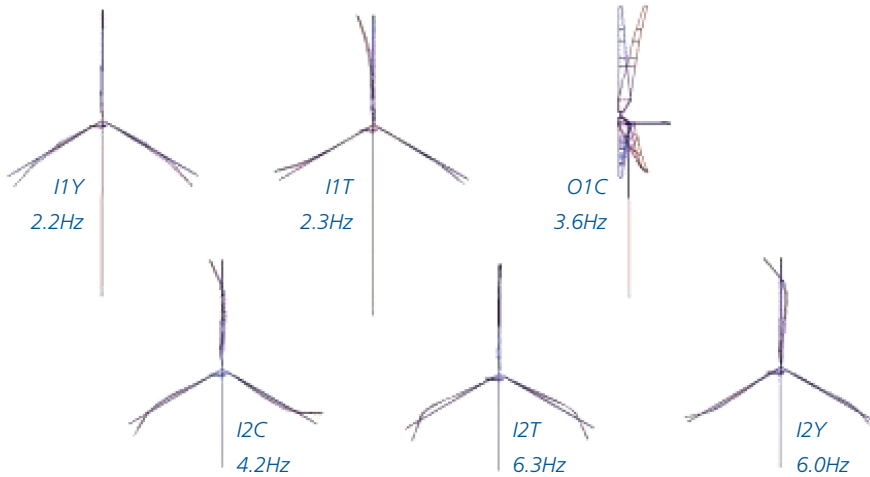

Whole turbine modes

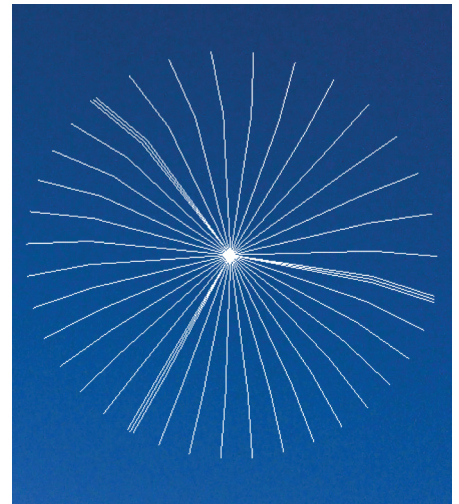

Rotating modes

RESULTS

Modes of the entire turbine

The modes of an entire wind turbine are different from those of the individual blades, so understanding how they interact is essential to the design of a long-lasting and efficient wind turbine.

The rotor has three blades connected together. The rotor's modes come from the blades' modes. Each blade mode – known from a lab blade test – converts into three rotor modes: one symmetric and two antisymmetric. For symmetric modes, all blades move in-phase, and for antisymmetric modes, two are in-phase and in antiphase with the third blade.

When the rotor spins, the two antisymmetric modes start to whirl, one in a clockwise direction and another anticlockwise. The frequencies at which the modes appear vary depending on the rotor speed.

More complexity

The interaction of blade and rotor modes with the tower's modes and the effect of centrifugal stiffening make analysis of rotor dynamics complex.

The combination of these phenomena can be observed using OMA. OMA is able to validate whether the wind turbine dynamics predicted by simulation software such as BLADED, or HAWC-2 represent real-world behaviour. If not, the numerical models have to be updated.

Linking testing with simulation

Finite element models are vital in the design of wind turbine blades. To ensure these simulation models are accurate and represent the true physical model, they are validated and updated using high-quality test data. Model correlation and updating is thus a key objective for DTU Wind Energy.



“IN TEN YEARS, I THINK THERE WILL BE EVEN MORE FOCUS ON MONITORING THE TURBINE, BECAUSE OPERATION AND MAINTENANCE OF TURBINES IS A LARGE PART OF THE COST OF WIND ENERGY.”

Per Hørlyk Nielsen, Development Engineer at DTU Wind Energy

In PULSE Reflex Correlation Analysis, the OMA test results from the lab measurement are compared to the simulation results from the FE model. The initial FE model was done using MSC Patran. It contains approximately 70,000 nodes compared to the test model size of 20 nodes. Discrepancies between the simulation predictions and the OMA test results were found and the initial FE model was updated.

CONCLUSION

OMA has proven itself an ideal technique for modal analysis of wind turbine blades, and a significant improvement over conventional classical modal analysis in the lab. In the field, measuring on entire wind turbines with rotating blades, OMA plays a key role in observing and understanding the complex vibrational behaviour.

The experience of testing long-term monitoring solutions over six months has been hugely valuable in terms of proving the equipment and systems needed, all of which is supplied by Brüel & Kjær – from transducer to model correlation software. Consequently, the researchers at DTU Wind Energy are able to improve their understanding of the structural performance of wind turbines, and improve the accuracy of FE models, using operational measurement results. Working together, Brüel & Kjær and DTU Wind Energy have confidently opened the door to extended structural health monitoring.

Brüel & Kjær benefitted from the opportunity to collect data for structural health monitoring algorithms, and from sharing expertise. As Niels-Jørgen Jacobsen, Product Manager for Structural Dynamics Solutions at Brüel & Kjær says, "The exchange of domain knowledge between DTU Wind Energy and Brüel & Kjær has been hugely beneficial. Working together has given the unique opportunity to share knowledge from different areas relating to the disciplines involved, and we look forward to continue working together in future."

www.bksv.com/casestudies

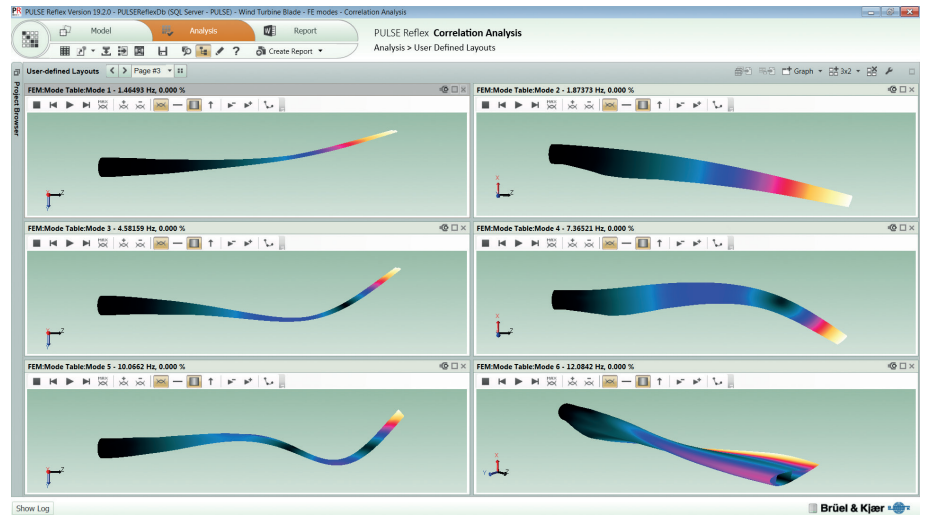

An intuitive user interface and workflow makes it easy to import FE results from leading solvers including NASTRAN®, ANSYS®, and ABAQUS®, or as UFF files, and make visual and numerical correlations of the FE and test modal models. The first 6 elastic FE modes are shown

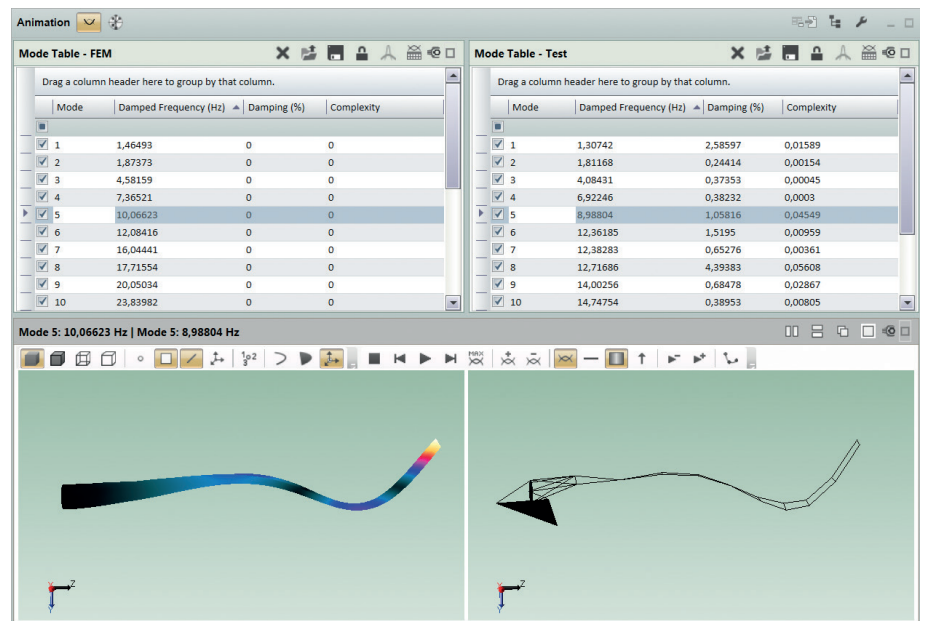

The mode shapes obtained from the OMA test and the simulation predictions can be animated together in various formats and the mode shapes can be correlated to identify discrepancies between predictions and test results, to improve the understanding and development of FE models