

SOUND INTENSITY

THE FUNDAMENTALS OF SOUND INTENSITY MEASUREMENT

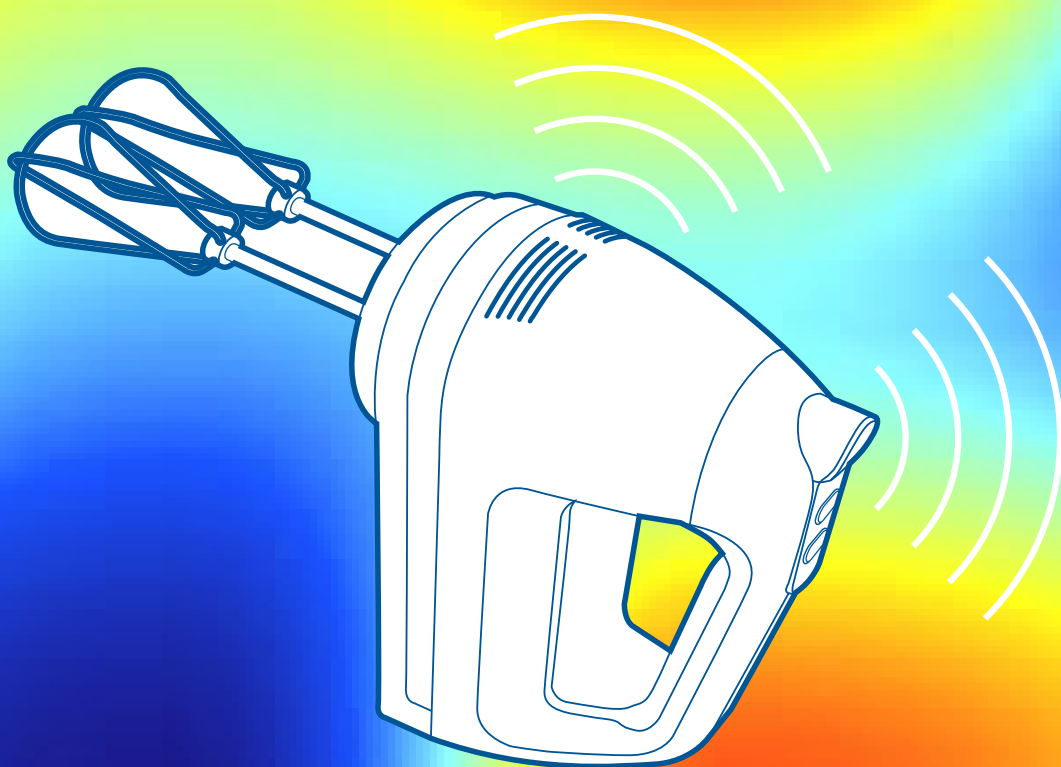

This booklet sets out to explain the fundamentals of sound intensity measurement. Both theory and applications will be covered. Although the booklet is intended as a basic introduction, some knowledge of sound pressure measurement is assumed. If you are unfamiliar with this subject, you may wish to consult our companion booklet 'Measuring Sound'.

CONTENTS

Introduction	2
Sound Pressure and Sound Power	3
What is Sound Intensity?	4
Why Measure Sound Intensity?	5
Sound fields	6-7
Pressure and Particle Velocity	8
How is Sound Intensity Measured?	9-10
The Sound Intensity Probe	11
Using Sound Intensity to Determine Sound Power	12
Spatial Averaging	13
What about Background Noise?	14
Intensity Mapping	15-16
Instrumentation	17
Making Measurements	18-19
Further Reading	20-22

INTRODUCTION

The air pressure variations that we perceive as sound can be measured simply using a sound level meter. These sound pressure level measurements provide an accurate picture of the sound levels at the measurement point, but they are not always sufficient to answer questions about the sources of that sound.

Sound intensity measurement is a more powerful technique that allows us to measure the flow of sound energy as a time-averaged vector quantity. These properties of sound intensity allow us to separate sound sources and to distinguish direct sound from reverberant sound in a room.

This primer introduces the subject of sound intensity measurement, including the basic theory, how it is measured in practice, and common applications.

SOUND PRESSURE AND SOUND POWER

A sound source radiates power and this results in a sound pressure. Sound power is the cause. Sound pressure is the effect. Consider the following analogy. An electric heater radiates heat into a room and temperature is the effect. Temperature is also the physical quantity that makes us feel hot or cold. The temperature in the room is obviously dependent on the room itself, the insulation, and whether other sources of heat are present. But for the same electrical power input, the heater radiates the same power, practically independent of the environment. The relationship between sound power and sound pressure is similar. What we hear is sound pressure but it is caused by the sound power emitted from the source.

The sound pressure that we hear or measure with a microphone is dependent on the distance from the source and the acoustic environment (or sound field) in which sound waves are present. This in turn depends on the size of the room and the sound absorption of the surfaces. So by measuring sound pressure we cannot necessarily quantify how much noise a machine makes. We have to find the sound power because this quantity is more or less independent of the environment and is the unique descriptor of the noisiness of a sound source.

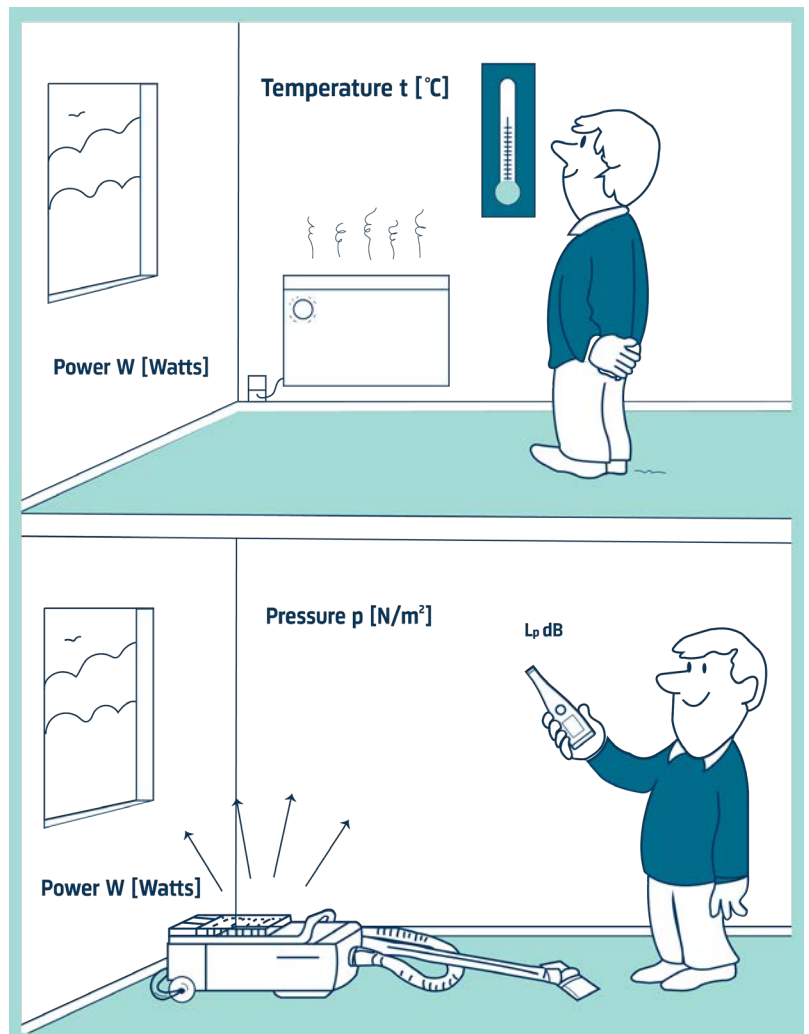

WHAT IS SOUND INTENSITY?

Any piece of machinery that vibrates radiates acoustical energy. Sound power is the rate at which energy is radiated (energy per unit time). Sound intensity describes the rate of energy flow through a unit area. In the SI system of units, the unit area is 1 m². And hence the units for sound intensity are Watts per square metre.

Sound intensity also gives a measure of direction as there will be energy flow in some directions but not in others. Therefore, sound intensity is a vector quantity as it has both magnitude and direction. On the other hand, pressure is a scalar quantity as it has magnitude only. Usually we measure the intensity in a direction normal (at 90°) to a specified unit area through which the sound energy is flowing.

We also need to state that sound intensity is the time-averaged rate of energy flow per unit area. In some cases, energy may be travelling back and forth. This will not be measured; if there is no net energy flow there will be no net intensity.

In the diagram opposite, the sound source is radiating energy. All this energy must pass through an area enclosing the source. Since intensity is the power per area, we can easily measure the normal spatial-averaged intensity over an area which encloses the source and then multiply it by the area to find the sound power. Note that intensity (and pressure) follows the inverse square law for free field propagation.

This can be seen in the diagram, at a distance 2r from the source the area enclosing the source is 4 times as large as the area at a distance r. Yet the power radiated must be the same whatever the distance and consequently the intensity, the power per area, must decrease.

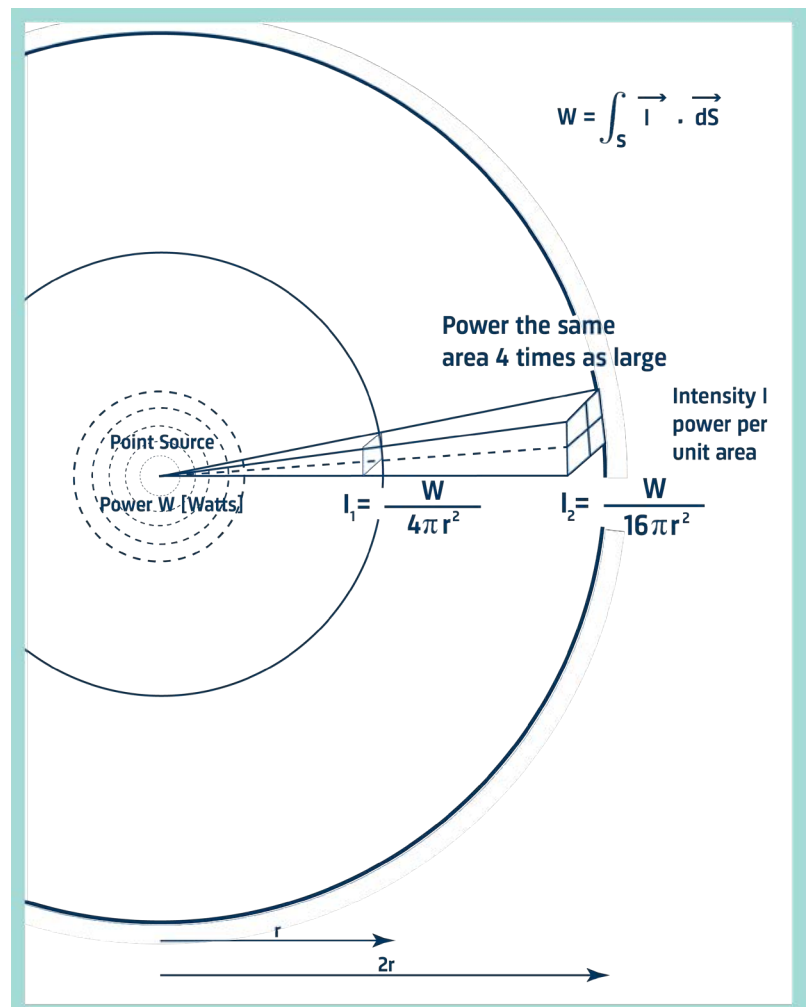

WHY MEASURE SOUND INTENSITY?

We can determine the sound power of an object from measurements of sound pressure, but there are practical challenges. While sound power can be related to sound pressure, it is only under carefully controlled conditions where special assumptions are made about the sound field. Specially constructed rooms such as anechoic or reverberant chambers fulfil these requirements. Traditionally, to measure sound power, the noise source had to be placed in these rooms.

Sound intensity, however, can be measured in any sound field. No assumptions need to be made. This property allows all the measurements to be done directly in situ. And measurements on individual machines or individual components can be made even when all the others are radiating noise, because steady background noise makes no contribution to the sound power determined when measuring intensity.

Because sound intensity gives a measure of direction as well as magnitude it is also very useful when locating sources of sound. Therefore, the radiation patterns of complex vibrating machinery can be studied in situ.

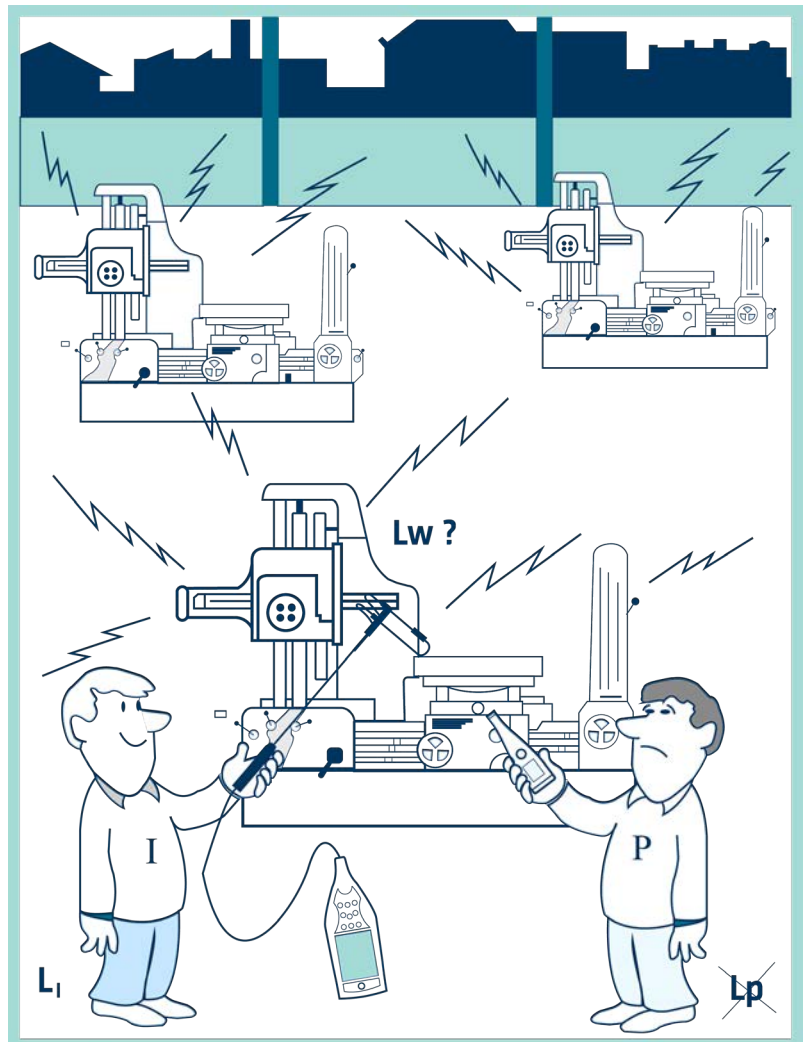

SOUND FIELDS

A sound field is a region where there is sound. It is classified according to the manner and the environment in which the sound waves travel. Some examples will now be described and the relationship between pressure and intensity discussed. This relationship is precisely known only in the first two special cases described below.

The Free Field

This term describes sound propagation in idealized free space where there are no reflections. These conditions hold in the open air (sufficiently far enough away from the ground) or in an anechoic room where all the sound striking the walls is absorbed. Free field propagation is characterized by a 6 dB drop in sound pressure level and intensity level (in the direction of sound propagation) each time the distance from the source is doubled. This is simply a statement of the inverse square law. The relationship between sound pressure and sound intensity (magnitude only) is also known. It gives one way of finding sound power, which is described in the International Standards ISO 3744, 3745 and 3746.

component. One-sided intensity cannot be measured by a sound intensity analyzer but it is nevertheless a useful quantity: by measuring pressure, we can use the relationship between pressure and one-sided intensity to find the sound power. This is described in ISO 3741, 3743 and 3747.

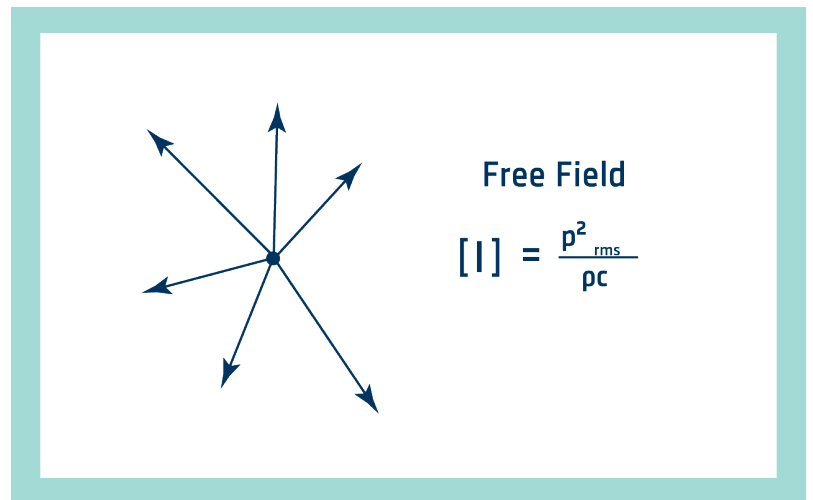

The Diffuse Field

In a diffuse field, sound is reflected so many times that it travels in all directions with equal magnitude and probability. This field is approximated in a reverberant room. Although the net intensity is zero, there is a theoretical relationship which relates the pressure in the room to the one-sided Intensity, I_x . This is the intensity in one direction, ignoring the equal and opposite

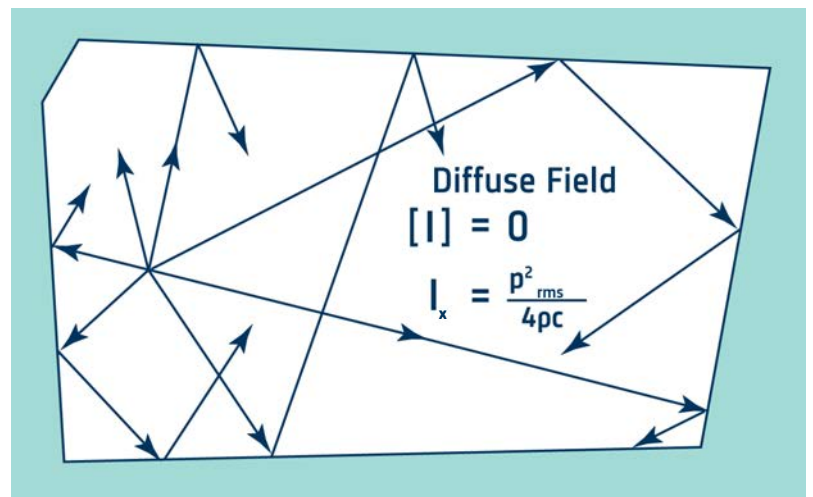

Active and Reactive Sound Fields

Sound propagation involves energy flow but there can still be a sound pressure even when there is no propagation. An active field is one where there is energy flow. In a pure reactive field, there is no energy flow. At any instant, energy may be travelling outward, but it will always be returned at a later instant. The energy is stored as if in a spring. Hence the net intensity is zero. In general, a sound field will have both active and reactive components. Pressure measurements for sound power in fields, which are not well-defined, can be unreliable, since the reactive part is unrelated to the power radiated. We can, however, measure sound intensity. Since sound intensity describes energy flow, there will be no contribution from the reactive component of the field. Two examples of reactive fields follow.

Standing Waves in a Pipe

Consider a piston exciting the air at one end of a tube. At the other end, there is a termination which causes the sound waves to be reflected. The combination of the forward-travelling and reflected waves produces patterns of pressure maxima and minima, which occur at fixed distances along the tube. If the termination is completely rigid, all the energy is reflected and the net intensity is zero. With an absorptive termination, some intensity will be measured. Standing waves are also present in rooms at low frequencies.

The Near Field of a Source

Very close to a source, the air acts as a mass-spring system which stores the energy. The energy circulates without propagating and the region in which it circulates is called the near field. Only sound intensity measurements for sound power determination can be made here. And because it is possible to get close to the source, the signal-to-noise ratio is improved.

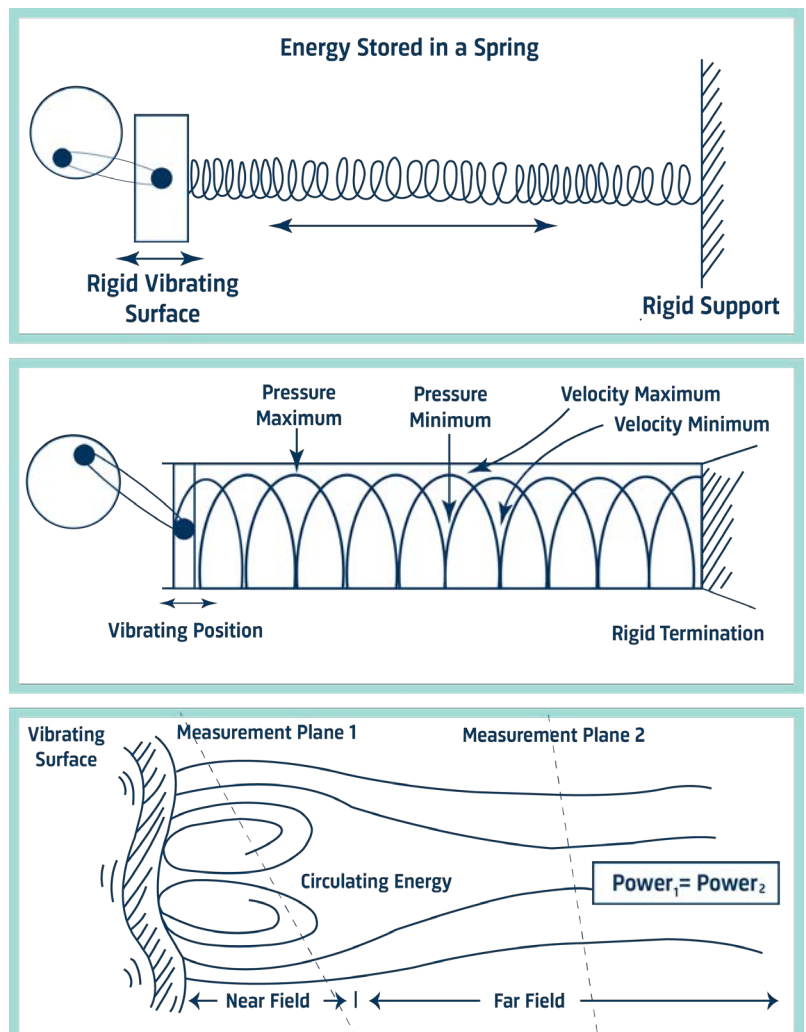

PRESSURE AND PARTICLE VELOCITY

When a particle of air is displaced from its mean position, there is a temporary increase in pressure. The pressure increase acts in two ways: to restore the particle to its original position, and to pass on the disturbance to the next particle. The cycle of pressure increases (compressions) and decreases (rarefactions) propagates through the medium as a sound wave. There are two important parameters in this process: the pressure (the local increases and decreases with respect to the ambient) and the velocity of the particles of air which oscillate about a fixed position. Sound intensity is the product of particle velocity and pressure. And, as can be seen from the transformation below, it is equivalent to the power per unit area definition given earlier.

$$\text{Intensity} = \text{Pressure} \times \text{Particle Velocity}$$

$$= \frac{\text{Force}}{\text{Area}} \times \frac{\text{Distance}}{\text{Time}} = \frac{\text{Energy}}{\text{Area} \times \text{Time}} = \frac{\text{Power}}{\text{Area}}$$

In an active field, pressure and particle velocity vary simultaneously. A peak in the pressure signal occurs at the same time as a peak in the particle velocity signal. They are, therefore, said to be in phase and the product of the two signals gives a net intensity. In a reactive field, the pressure and particle velocity are 90° out of phase. One is shifted a quarter of a wavelength with respect to the other. Multiplying the two signals together gives an instantaneous intensity

signal varying sinusoidally about zero. Therefore, the time-averaged intensity is zero. In a diffuse field the pressure and particle velocity phase vary at random and so the net intensity is zero.

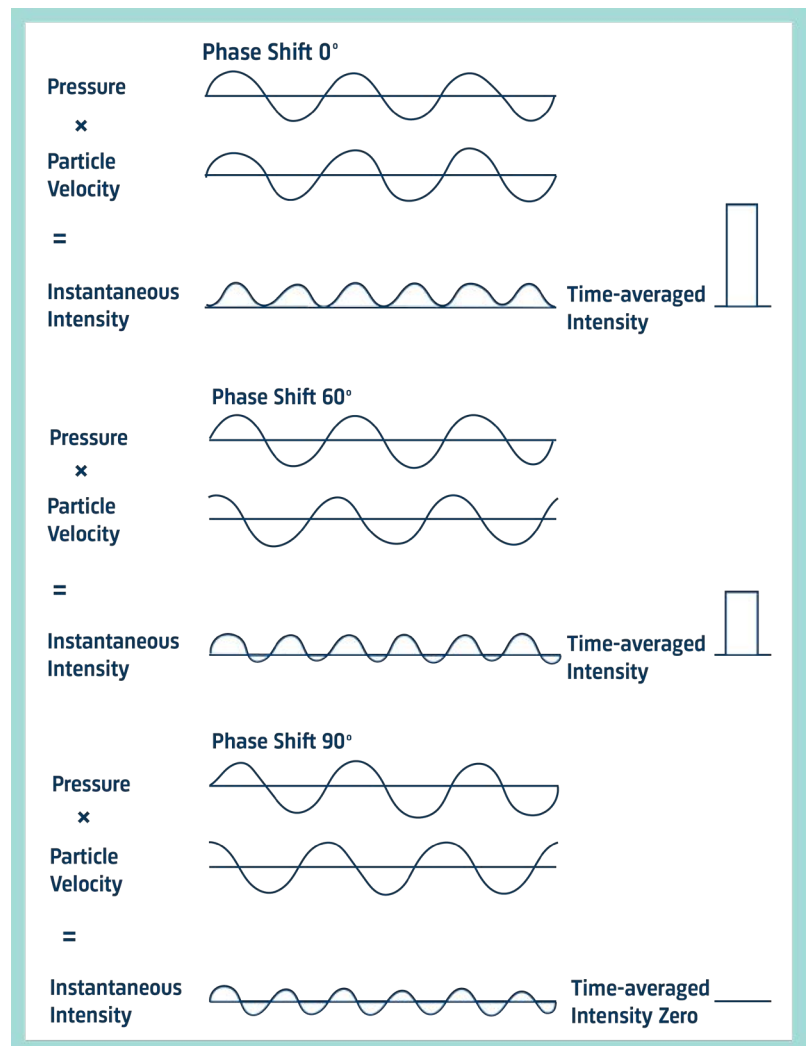

HOW IS SOUND INTENSITY MEASURED?

The Euler Equation:

Finding the Particle Velocity

Sound intensity is the time-averaged product of the pressure and particle velocity. A single microphone can measure pressure – this is not a problem. But measuring particle velocity is not as simple. The particle velocity, however, can be related to the pressure gradient (the rate at which the instantaneous pressure changes with distance) with the linearized Euler equation. With this equation, it is possible to measure this pressure gradient with two closely spaced microphones and relate it to particle velocity.

Euler's equation is essentially Newton's second law applied to a fluid. Newton's second law relates the acceleration given to a mass to the force acting on it. If we know the force and the mass, we can find the acceleration and then integrate it with respect to time to find the velocity.

With Euler's equation it is the pressure gradient that accelerates a fluid of density ρ . With knowledge of the pressure gradient and the density of the fluid, the particle acceleration can be calculated. Integrating the acceleration signal then gives the particle velocity.



Sir Isaac Newton

$$F = ma$$

$$a = \frac{F}{m}$$

$$v = \int \frac{F}{m} dt$$



Leonhard Euler

$$a = - \frac{1}{\rho} \text{grad } p$$

in one direction

$$\frac{\partial u}{\partial t} = - \frac{1}{\rho} \frac{\partial p}{\partial r}$$

$$u = - \int \frac{1}{\rho} \frac{\partial p}{\partial r} dt$$

The Finite Difference Approximation

The pressure gradient is a continuous function, that is, a smoothly changing curve. With two closely spaced microphones, it is possible to obtain a straight line approximation to the pressure gradient by taking the difference in pressure and dividing by the distance between them. This is called a finite difference approximation. It can be thought of as an attempt to draw the tangent of a circle by drawing a straight line between two points on the circumference.

The Intensity Calculation

The pressure gradient signal must now be integrated to give the particle velocity. The estimate of particle velocity is made at a position in the acoustic centre of the probe, between the two microphones. The pressure is also approximated at this point by taking the average pressure of the two microphones. The pressure and particle velocity signals are then multiplied together and time averaging gives the intensity.

A sound intensity analyzing system consists of a probe and an analyzer. The probe simply measures the pressure at the two microphones. The analyzer does the integration and calculations necessary to find the sound intensity.

Time Domain Formulation

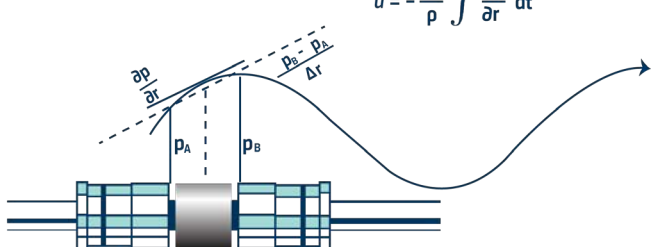

The Finite Difference Approximation

From Euler

$$u = -\frac{1}{\rho} \int \frac{\partial p}{\partial r} dt$$

Average Pressure

$$p = \frac{p_A + p_B}{2}$$

$$I = \overline{p \cdot u}$$

$$I = -\frac{p_A + p_B}{2\rho\Delta r} \int (p_B - p_A) dt$$

Frequency Domain Formulation for FFT Analyzers

$$I = -\frac{1}{\rho\omega\Delta r} \text{Im } G_{AB}$$

ω is the angular frequency

$\text{Im } G_{AB}$ is the imaginary part of the cross spectrum

THE SOUND INTENSITY PROBE

The Brüel & Kjær probe has two microphones mounted face to face with a solid spacer in between. This arrangement has been found to have better frequency response and directivity characteristics than side-by-side, back-to-back or face-to-face without solid spacer arrangements. Three solid spacers define the effective microphone separation to 6, 12 or 50 mm. The choice of spacer depends on the frequency range to be covered.

Directivity Characteristics

The directivity characteristic for the sound intensity analyzing system looks (two-dimensionally) like a figure-of-eight pattern – known as a cosine characteristic. This is due to the probe and the calculation within the analyzer.

Since pressure is a scalar quantity, a pressure transducer should have an equal response, no matter what the direction of sound incidence (that is, we need an omnidirectional characteristic). In contrast, sound intensity is a vector quantity. With a two-microphone probe, we do not measure the vector however; we measure the component in one direction, along the probe axis. The full vector is made up of three mutually perpendicular components (at 90° to each other) – one for each coordinate direction.

For sound incident at 90° to the axis there is no component along the probe’s axis, as there will be no difference in the pressure signals. Hence there will be zero particle velocity and zero intensity. For sound incident at an arbitrary angle θ to the axis, the intensity component along the axis, will be reduced by the factor $\cos\theta$. This reduction produces the cosine directivity characteristic.

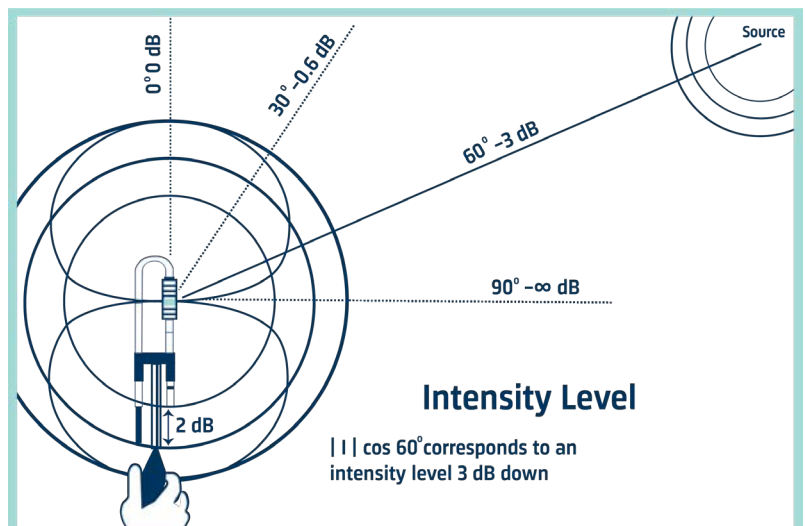
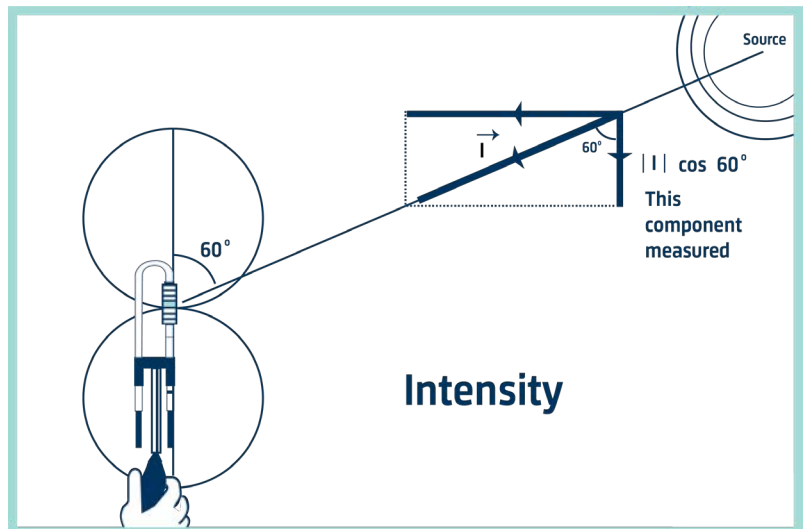

USING SOUND INTENSITY TO DETERMINE SOUND POWER

The use of sound intensity rather than sound pressure to determine sound power means that measurements can be made in situ, with steady background noise and in the near field of machines. It is above all a simple technique. The sound power is the average normal intensity over a surface enclosing the source, multiplied by the surface area. First we need to define this hypothetical surface.

We can choose any enclosing surface as long as no other sources or sinks (absorbers of sound) are present within the surface. The floor is assumed to reflect all the power and so need not be included in the measuring surface. The surface may, in theory, be any distance from the source.

Here are two examples:

First, the box. This can be any shape and size. This surface is easy to define and the planar surfaces make averaging the intensity over the surface a simple matter. The partial sound powers can be found from each side and added.

Second, the hemisphere. This shape is most likely to give the least number of measuring points. For an omnidirectional source in the free field the intensity will be constant over a hemisphere.

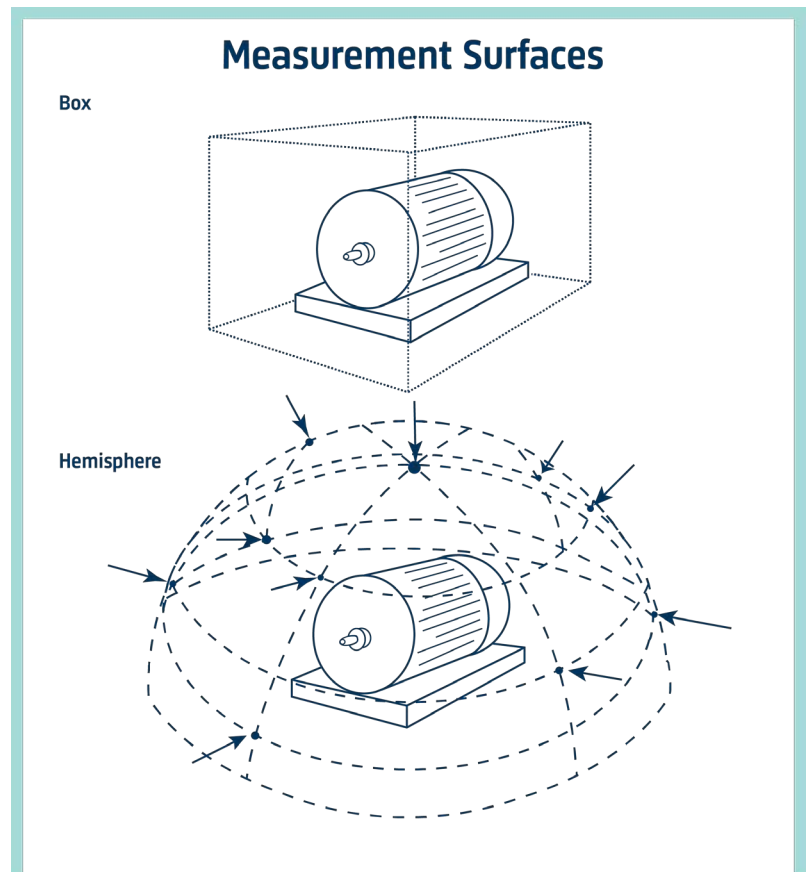

SPATIAL AVERAGING

After a surface has been defined, we need to spatially average the intensity values measured normal to the surface. Note that the surface can be defined with a physical grid or just as distances from reference points. ISO 9614 contains three parts, each of which defines a different measurement method. Part 1 covers discrete point averaging and Parts 2 and 3 cover variations on swept or scanning measurements across the surface. Part 3 addresses extra requirements for measuring in a laboratory environment.

Discrete Point Averaging

In this method, the measurement surface is divided into small segments and individual measurements are made at one point per segment. The measuring points are frequently defined by a grid. This can be a frame with string or wire, although a ruler or tape measure can also be used. The results are averaged and multiplied by the surface area to find the sound power from the side.

Neither method is best for all applications and in some cases both methods may be useful. Because the swept technique is mathematically a better approximation to the continuous space integral, it is often more accurate. But care needs to be taken to sweep the probe at a constant rate and to cover the surface equally. The discrete point method, however, is often more repeatable. Both can easily be automated if repeated measurements have to be made. This also improves the accuracy.

Swept Measurements over the Surface

With a suitably long averaging time, the probe is simply swept over the surface, as if the surface is being painted. This gives a single-value spatial average intensity. Multiplying by the area gives the sound power from this surface. Then the sound power contributions from all the surfaces are added.

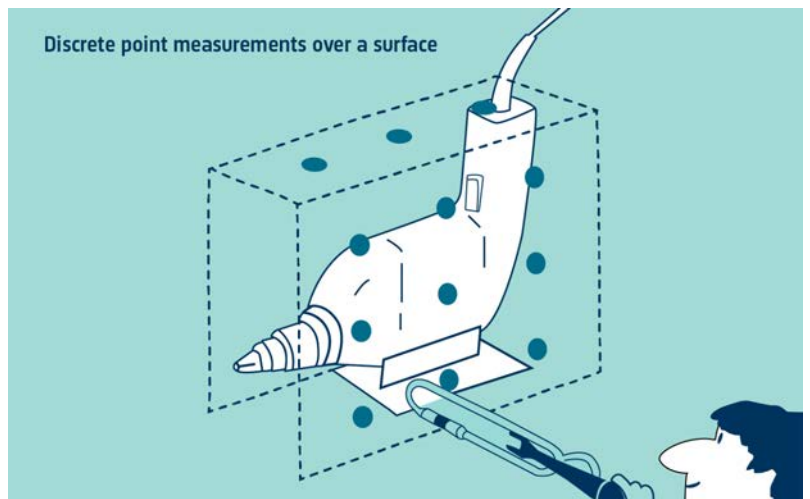
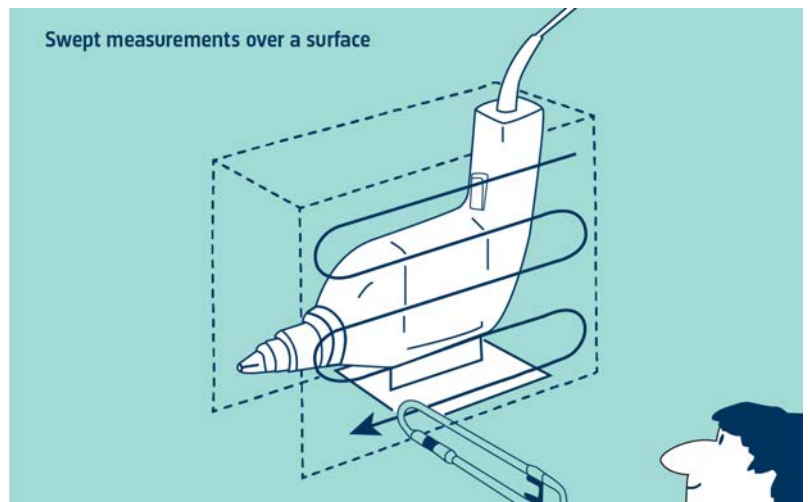

WHAT ABOUT BACKGROUND NOISE?

One of the main advantages of the intensity method of sound power determination is that high levels of steady background noise are not important.

Let us imagine a surface in space – any closed volume will do. If a sound source is present within the closed surface then we can measure the average intensity over the surface of the box and multiply by the area to find the total sound power radiated by the source.

If the source were then moved outside the box and we tried to find the sound power we would measure zero. We will always measure some energy flowing in on a side. But the energy will flow out on other sides and so the contribution to the sound power radiated from the box will be zero.

For this to be true, the background noise level must not vary significantly with time. If this condition is met, the noise is said to be stationary. Note, with a long enough averaging time, small random fluctuations in level will not matter. A further condition is that there must be no absorption within the box. Otherwise some background noise will not flow out of the box again.

Background noise can be regarded as sources outside the measurement box and will have no effect on the measured sound power of the source. In practice, this means that sound power can be measured to an accuracy of 1 dB from sources as much as 10 dB lower than the background noise. If background noise is a problem, then choosing a smaller measurement surface will improve the signal-to-noise ratio.

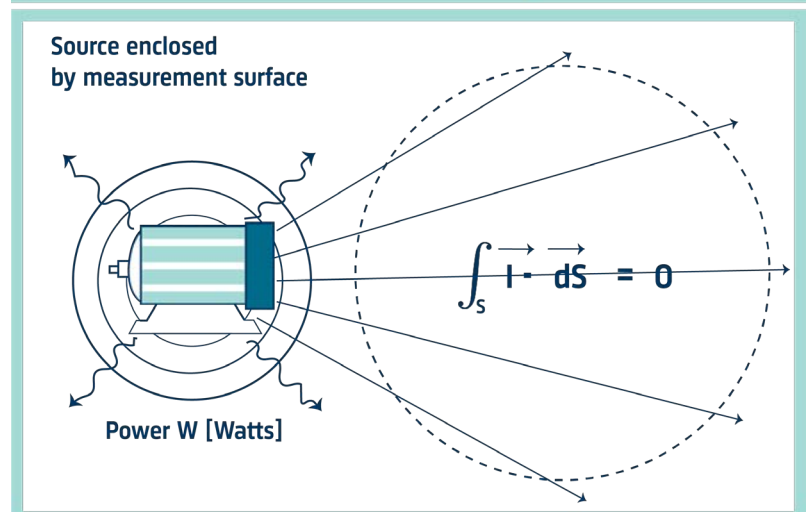
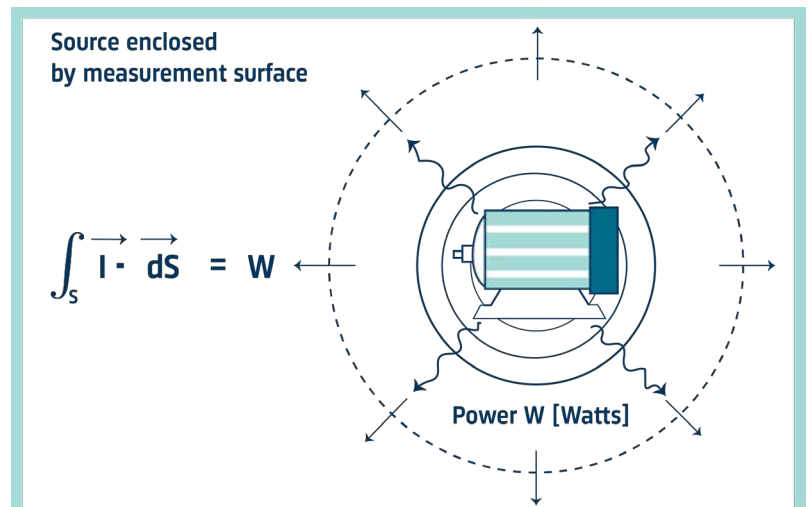

INTENSITY MAPPING

Every noise control problem is first of all a problem of location and identification of the source. Sound intensity measurement offers several ways of doing this, which have considerable advantages over sound pressure measurement techniques.

Contour Plots

Contour plots give a more detailed picture of the sound field generated by a source. Several sources and/or sinks can then be identified with accuracy.

A grid is set up to define a surface. Sound intensity measurements normal to the surface are made from a number of equally spaced points on the surface. We can use the same measurements to calculate the sound power over the grid. These values are then stored. There is now a matrix of intensity levels – one value for each point. Lines of equal intensity can be drawn by interpolating and joining up points of equal intensity.

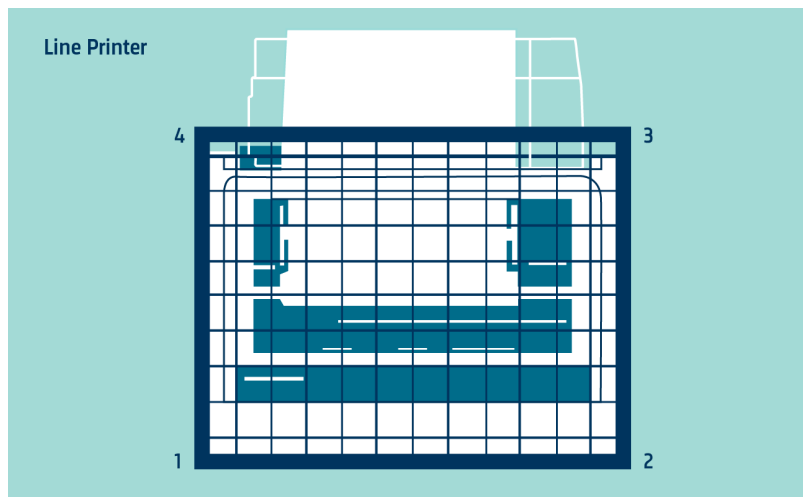
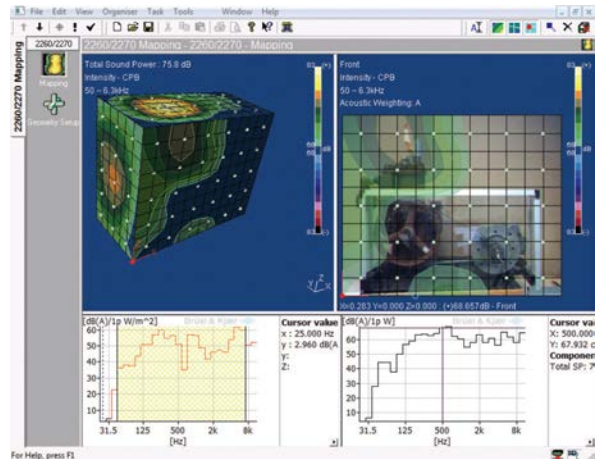
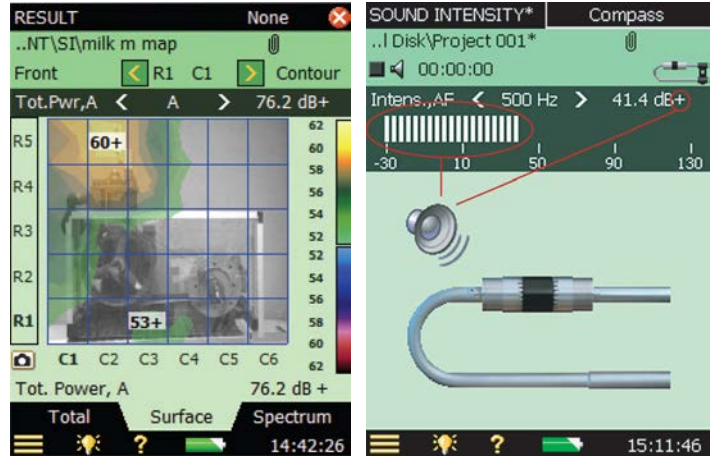

**Source Location –
the Null Search Method**

As a quick and easy test, we can make use of the probe’s directional characteristic. Sound incident at 85° to the axis will be recorded as positive-going intensity, whereas sound at 95° will give negative-going intensity. Therefore, there is a change in direction for only a small change in angle.

While we watch the display, the probe is swept so that its axis makes a line parallel to the plane on which we think the source is located. At some point, the direction will suddenly change. This position is identified where the display alternates rapidly between positive- and negative-going intensity. Here the sound must be incident on the probe at 90° to its axis and thus we have located the source. This method is useful when only one source is dominant – other sources or sinks may confuse the results.

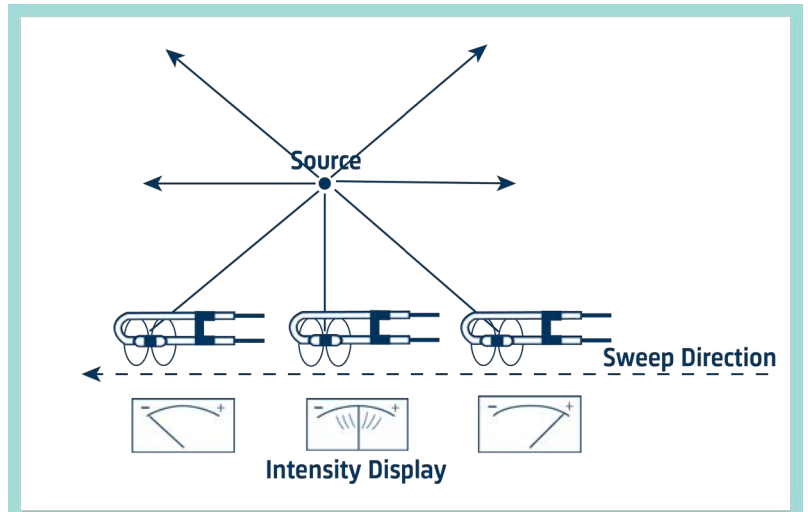
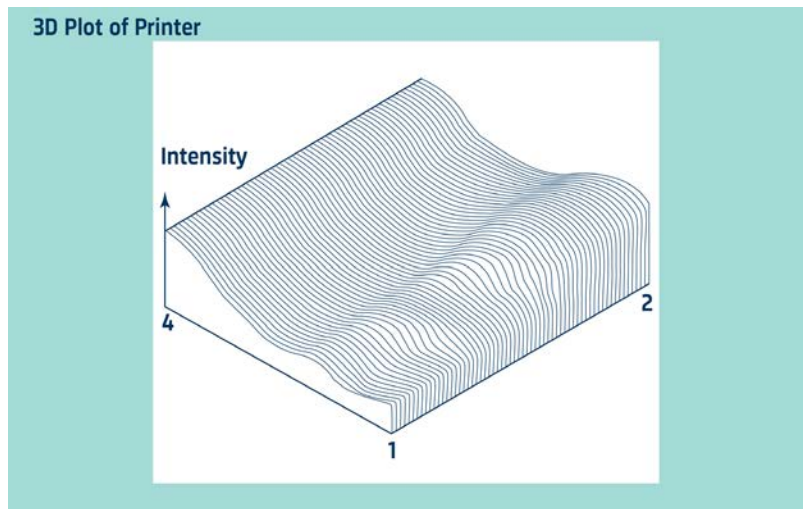
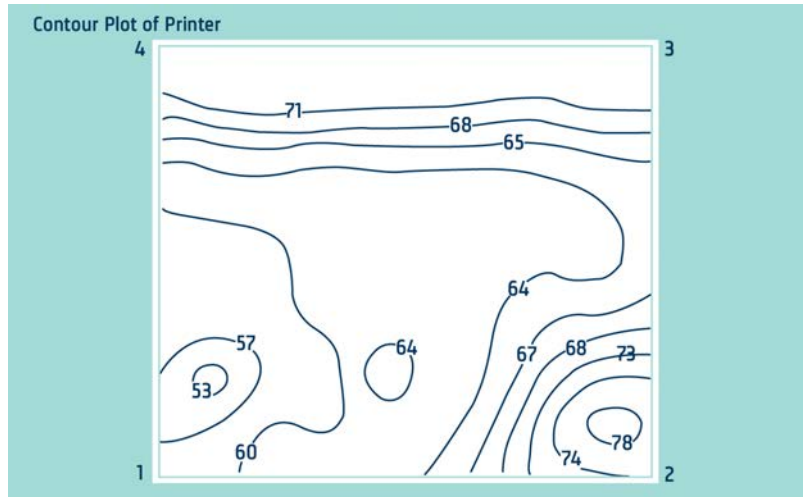

INSTRUMENTATION

There are three essential components in a sound intensity analyzing system: data acquisition system, probe and calibrator. Brüel & Kjær makes a complete range of these components, as well as providing post-processing software packages, to give a choice of systems dedicated to intensity measurement.

Brüel & Kjær offers sound intensity measurement solutions optimized for both laboratory and field use.

Hand-held Analyzer Type 2270 with Sound Intensity Software BZ-7233 is a highly portable real-time sound intensity analyzer, ideally suited to field measurements. The analyzer provides measurement guidance and workflow support for sound power determination according to ISO 9614-1, ISO 9614-2, ANSI S12.12 and ECMA 160.

PULSE™ Sound Power Using Sound Intensity Type 7882 is software for determining sound power according to ISO 9614-1, ISO 9614-2 and ISO 9614-3. Combined with Sound Intensity Probe Type 3599 and a suitable LAN-XI module, Type 7882 forms a solution ideal for sound power determination in the laboratory.

The Sound Intensity Calibrator

Type 4297 is a complete sound-intensity calibrator in one compact, portable unit with built-in sound sources. Unlike older sound intensity calibrators, Type 4297 can be used without dismantling the sound intensity probe, making it ideal for both field and laboratory use.

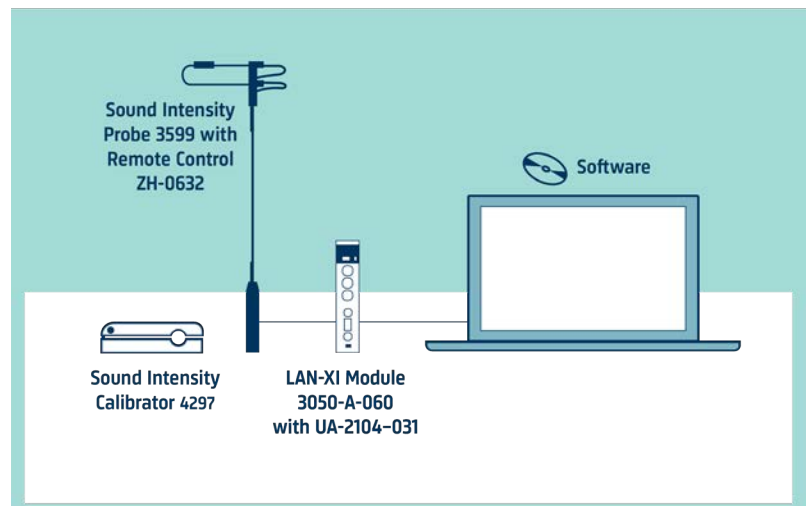
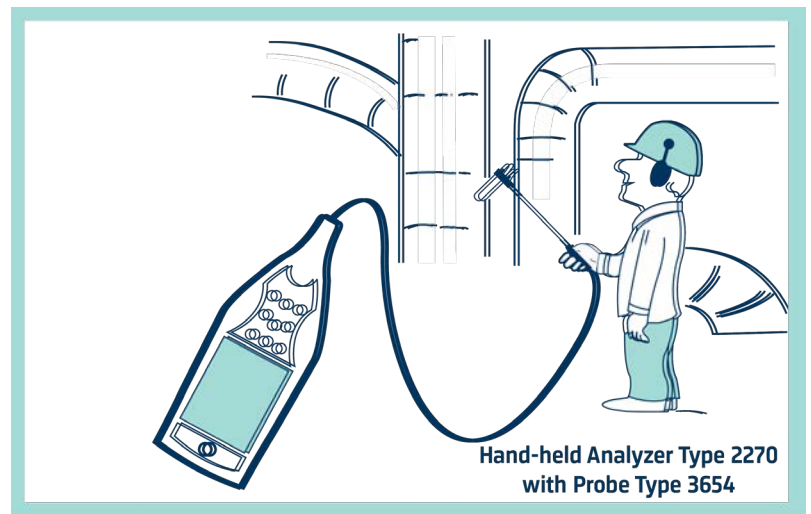

MAKING MEASUREMENTS

Time Averaging

To minimize the random error, we require an averaging time long enough to give steady results. To judge the averaging time needed, several measurements can be taken and the averaging time increased until the results are repeatable.

Spatial Averaging

With swept measurements we must cover all areas equally. The sweep rate must, therefore, be constant and the area must be covered with a whole number of sweeps. With discrete point measurements, the variability in the intensity over the measuring surface determines the number of points needed. If the variability is high, the number of measuring points must be increased. It is easy to see when the spatial averaging is correct. Repeatable results for a number of different measurement surfaces, or for different measuring positions on the same surface, imply correct spatial averaging.

Background Noise

Providing the background noise is steady, measurements can be made to an accuracy of 1 dB even when the background level exceeds the source level by as much as 10 dB. If it is possible, measuring the sound power with the source turned off (background noise on) will give an idea of the contribution of the background noise. The effect of background noise is reduced by measuring closer to the source.

Frequency Limit

The two microphones approximate the gradient of a curve to a straight line between two points. If the curve changes too rapidly with distance, the estimate will be inaccurate. This will happen if the wavelength measured becomes small compared to the effective spacer distance.

Because it is the effective spacer distance that is compared to the wavelength, the sound intensity directional characteristics for the probe will be distorted. Most severely in the direction along the probe axis (see Figure below). For a given effective spacer distance there will be a high frequency limit beyond which errors will increase significantly. For accuracy to be within 1 dB, the wavelength measured must be greater than six times the spacer distance. This corresponds to the following high frequency limits:

- 50 mm spacer: up to 1.25 kHz
- 12 mm spacer: up to 5 kHz
- 6 mm spacer: up to 10 kHz

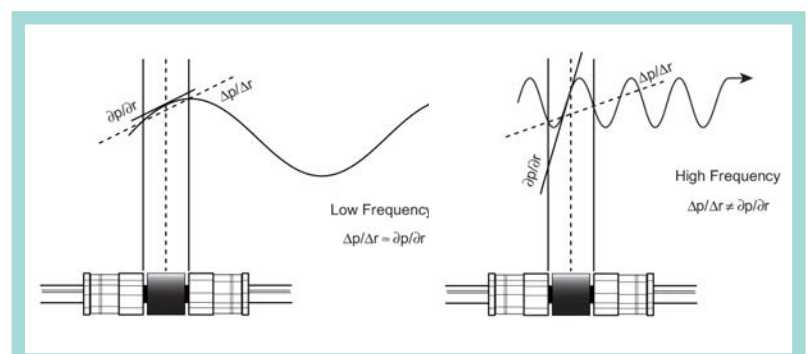

Extended High Frequency Limit

The face-to-face configuration of the two microphones causes resonance in the small cavity between the spacer and the membrane of the microphone. This in turn causes an increase in pressure for sound incidence along the probe axis. The pressure increase does, to some extent, compensate for distortion of the directional characteristic of the probe caused by the finite difference error.

Therefore, the operational frequency range for a Brüel & Kjær probe can be extended to an octave above the limit determined by the finite difference error if the length of the spacer between the microphones equals the diameter of the microphones, and if the levels are compensated with an optimized frequency response for the microphone pair. This phenomena was originally discovered by the authors of 'A Sound Intensity Probe for Measuring from 50 Hz to 10 kHz'; F. Jacobsen, V. Cutanda and P.M. Juhl: Brüel & Kjær Technical Review, No.1, 1996.

Low Frequency Limit

At low frequencies, there will be only a small difference between the signals from the two microphones. The measurements will therefore be more sensitive to self-generated noise and phase mismatch errors in the measurement equipment.

These problems can be reduced by using a longer spacer between the microphones, but this will reduce the high frequency limit.

The same sound signal arrives at the two microphones with a small delay that is used to calculate the velocity of the sound propagation. Because there are translations between delay, phase, and pressure-intensity index for sound intensity measurements, errors from the phase perspective can be examined and translated into the pressure-intensity index perspective.

Both the microphones and the electrical components in the measurement channels change the phase of the signals. Any difference in the change in the two channels will yield phase mismatch errors. The amount of phase mismatch between the two channels in the analyzing system determines the low frequency limit. At high frequencies, the change in phase across the spacer distance is big. For example, the phase change is 65° at 5 kHz over a 12 mm spacer. On the other hand, at low frequencies, the change in phase across the spacer distance is small. At 50 Hz, the change of phase over a 12 mm spacer is only 0.65° . For accuracy to within 1 dB, the phase change over the spacer distance should be more than five times the phase mismatch.

The international standard for sound intensity instruments IEC 61043 sets minimum requirements for the instruments' pressure-residual intensity index. These requirements can be translated into phase errors for the whole system giving $\pm 0.086^\circ$ at 50 Hz and $\pm 1.7^\circ$ at 5 kHz.

FURTHER READING

Brüel & Kjær is at the forefront of new developments and is constantly introducing new applications and improving older techniques. These advances are recorded in a series of application notes published regularly by Brüel & Kjær.

Review Articles

S. GADE

Sound Intensity (Part 1 Theory)
Brüel & Kjær Technical Review 3, 3 – 39
(1982)

S. GADE

Sound Intensity (Part 2 Instrumentation and Applications)
Brüel & Kjær Technical Review 4, 3 – 32
(1982)

S. GADE

Sound Intensity and its Application in Noise Control
Sound and Vibration March, 14-26 (1985)

Historical Background

C. F. CLAPP & F. A. FIRESTONE

The Acoustic Watt Meter – An Instrument for Measuring Sound Energy Flow
J. Acoust. Soc. Am. 13, 124-136 (1941)

H. F. OLSON

System Responsive to the Energy Flow of Sound Waves
U.S. Patent No. 1.892,644 (1932)

Modern Formulations

T. J. SCHULTZ

Acoustic Wattmeter
J. Acoust. Soc. Am. 28, 693-699 (1956)

J. Y. CHUNG

Cross-Spectral Method of Measuring Acoustic Intensity Without Error Caused by Instrument Phase Mismatch
J. Acoust. Soc. Am. 64, 1613-1616 (1978)

F. J. FAHY

Measurement of Acoustic Intensity Using the Cross-Spectral Density of Two Microphone Signals
J. Acoust. Soc. Am. 62, 1057-1059 (Letter)
(1977)

F. J. FAHY

Sound Intensity
Elsevier Science Publishers LTD. (1990)

Applications

BRÜEL & KJÆR PUBLICATION

Intensity Measurements

Collection of papers. BA 7196 (1988)

B. FORSSEN & M. J. CROCKER

Estimation of Acoustic Velocity, Surface Velocity and Radiation Efficiency by use of the Two-Microphone Technique

J. Acoust. Soc. Am. 73, 1047-1053 (1983)

K. B. GINN & R. UPTON

Business Machines Measurements Using Sound Intensity

Brüel & Kjær Application Note BO 0126 (1986)

R. E. HALLIWELL & A. C. C. WARNOCK

Sound Transmission Loss: Comparison of Conventional Techniques with Sound Intensity Techniques

J. Acoust. Soc. Am. 77, 2094-2103 (1985)

P. KRUPPA

Measurement of Structural Intensity in Building Constructions

Applied Acoustics 19 (1986) 61 – 74

T. G. NIELSEN

Intensity Measurements in Building Acoustics

Brüel & Kjær Application Note BO 0147 (1986)

T. G. NIELSEN & E. WALTON

Sound Power Determination of Household Appliances on the Production Line

Brüel & Kjær Application Note BO 0148 (1986)

J. PEKKINEN, HALTON OY,

J. NUOTIO & K. B. GINN

Sound Insulation of Ventilation Elements using Sound Intensity Techniques

Brüel & Kjær Application Note BO 0151 (1986)

P. RASMUSSEN & T. L. MØLLER

Gated Sound-Intensity Measurements on a Diesel Engine

Brüel & Kjær Application Note BO 0203 (1987)

B. G. van ZYL, P. J. ERASMUS &

G. J. J. van der MERWE

Determination of Sound Reduction Indices in the Presence of Flanking Transmission

Applied Acoustics 19 (1986) 25 – 39

M. L. S. VERCAMMEN,

H. J. MARTIN & W. CORNELISSEN

Application of the Intensity Measurement Technique to Building Acoustics and the Influence of an Absorbing Partition Wall on the Measured Intensity

Applied Acoustics 23 (1988) 45 – 62

ING. OPERTI, G. PRETI & K. B. GINN

Acoustical Testing in the Automotive Industry using STSF

Brüel & Kjær Application Note BO 0340 (1990)

Conference Proceedings

Proc. 1st International Congress on Recent Developments in Acoustic Intensity Measurement

CETIM, Senlis, France. (1981)

**Proc. 2nd International Congress
on Recent Developments
in Acoustic Intensity Measurement**

CETIM, Senlis, France. (1985)

**Proc. Symposium on Acoustic
Intensity**

Tokyo, Japan. (1987)

**Proc. 2nd Symposium on Acoustic
Intensity**

Tokyo, Japan. (1988)

**Proc. 3rd International Congress
on Intensity Techniques**

CETIM, Senlis, France. (1990)

Many other papers on sound intensity measurement can also be found in the **INTER-NOISE** proceedings from 1978 onwards

Measurement Accuracy

S. GADE

**The Validity of Intensity
Measurements in Partially Diffuse
Sound Field**

*Brüel & Kjær Technical Review 4, 3 – 31
(1985)*

A. F. SEYBERT

**Statistical Errors in Acoustic
Intensity Measurements**

J. Sound Vib. 75, 519-526 (1981)

P. S. WATKINSON

**The Practical Assessment of Errors
in Sound Intensity Measurement**

J. Sound Vib. 105, 255-263 (1986)

ISO Standards

ISO/DIS 9614 (Part 1)

**Determination of Sound Power
Levels of Noise – Sources
using Sound Intensity Part 1:
Measurement at Discrete Points**

ISO 3740 - 3746

**Determination of Sound Power
Levels of Noise Sources
(Pressure Measurements)**

See also ANSI S.1 31 – 36

We hope this booklet has answered many of your questions and will continue to serve as a handy reference. If you have other questions about sound intensity measuring techniques or instrumentation, please contact one of our local representatives or write us at: info@bksv.com

THE SOUND AND VIBRATION SPECIALIST